

Dell™ PowerVault™ TL2000 Tape Library and TL4000  
Tape Library

# User's Guide



Dell™ PowerVault™ TL2000 Tape Library and TL4000  
Tape Library

# User's Guide

**Information in this document is subject to change without notice.**

**© 2011 Dell Inc. All rights reserved.**

Reproduction in any manner whatsoever without the written permission of Dell Inc. is strictly forbidden.  
Trademarks used in this text: *Dell*, the *DELL logo* and *PowerVault* are trademarks of Dell Inc.

Other trademarks and trade names may be used in this document to refer to either the entities claiming the marks and names or their products. Dell Inc. disclaims any proprietary interest in trademarks and trade names other than its own.

Printed 2011

---

## Read This First

---

### Minimum Firmware Levels for Common Library Features

---

Table 1. Minimum Firmware Levels for common Library features

Feature	Minimum Firmware Level(s) Required
LTO HH V2 Tape Drives	Library firmware level must be at 10.00, or greater, to support HH V2 Tape Drives.
LTO 5 Tape Drive	Library firmware must be at 9.00, or greater, to support the Ultrium 5 drives. Ensure the minimum version required to support Ultrium 5 tape drives are installed on the host. Ensure any host applications and software, that use their own device drivers, are at the minimum level required to support Ultrium 5 tape drives.
Library BCR (Bar Code Reader)	Libraries manufactured after May 2010 may have a BCR that requires a minimum level of library firmware. The minimum level of firmware for these libraries is 9.00. Attempts to downlevel these libraries below 9.00 will be blocked by the library.
Dedicated Cleaning Slot removal	Library firmware level must be greater than 3.90.
Encryption	Library firmware level must be 5.80 or greater.  LTO4 Drive firmware level must be 77BE or greater.
Key Path Diagnostics	Library firmware level must be greater than 6.3, if feature is available.
Path Failover	LTO 4 Tape Drives: No minimum level of firmware is required.
IPv6 Support	Library firmware level: 4.50

---

## Contacting Dell

For customers in the United States, call 800-WWW-DELL (800-999-3355).

**Note:** If you do not have an active Internet connection, you can find contact information on your purchase invoice, packing slip, bill, or Dell product catalog.

Dell provides several online and telephone-based support and service options. Service availability varies by country and product, and some services may not be available in your area. To contact Dell for sales, technical support, or customer service issues follow the steps listed below:

1. Visit <http://support.dell.com>.
2. Verify your country or region in the **Choose A Country/Region** drop-down menu at the bottom of the page.

3. Click **Contact Us** on the left side of the page.
4. Select the appropriate service or support link based on your need.
5. Choose the method of contacting Dell that is convenient for you.

# Contents

## Read This First . . . . . iii

Minimum Firmware Levels for Common Library	
Features . . . . .	iii
Contacting Dell . . . . .	iii

## Figures . . . . . vii

## Tables . . . . . xi

## Safety and Environmental Notices . . . . . xiii

Danger Notice . . . . .	xiii
Caution Notice . . . . .	xiii
Laser Safety and Compliance . . . . .	xiv
Class I Laser Product . . . . .	xiv
Performing the Safety Inspection Procedure . . . . .	xiv
Rack Safety . . . . .	xv

## Preface . . . . . xix

Related Publications . . . . .	xix
--------------------------------	-----

## Chapter 1. Product Description . . . . . 1-1

Front Panel . . . . .	1-1
Rear Panel . . . . .	1-3
Bar Code Reader . . . . .	1-6
Encryption . . . . .	1-6
Supported Internet Protocols . . . . .	1-7
SNMP Messaging . . . . .	1-7
SNMP Traps . . . . .	1-7
Maximum Library Storage Capacity and Data	
Transfer Rate . . . . .	1-8
Ultrium Tape Drives . . . . .	1-9
Speed Matching . . . . .	1-10
Channel Calibration . . . . .	1-10
Power Management . . . . .	1-11
Media . . . . .	1-11
Library Specifications . . . . .	1-11
Product Environment . . . . .	1-13
Supported Device Drivers . . . . .	1-14

## Chapter 2. User Interfaces . . . . . 2-1

Operator Control Panel . . . . .	2-1
Operator Control Panel Philosophy . . . . .	2-1
Power-ON Display . . . . .	2-2
Note about the Front Panel LEDs . . . . .	2-2
Input Modes . . . . .	2-3
Power ON/OFF . . . . .	2-4
Web User Interface . . . . .	2-4
Login . . . . .	2-5
System Status . . . . .	2-6
Web User Interface Help Pages . . . . .	2-8
Logging out of the Web User Interface . . . . .	2-8

## Chapter 3. Installation Planning . . . . . 3-1

Determining the Number of Logical Libraries . . . . .	3-1
---	-----

Basic Guidelines . . . . .	3-1
Library Sharing . . . . .	3-1
Using Multiple Logical Libraries for Library	
Sharing . . . . .	3-2
Using Multiple Control Paths . . . . .	3-2
Using Multiple Control Paths for Path Failover . . . . .	3-2
Library Partitioning and Element Addressing . . . . .	3-2
Logical Unit Number (LUN) Scanning . . . . .	3-6
Host Interfaces . . . . .	3-7
SCSI Interface . . . . .	3-7
SAS Interface . . . . .	3-9
Fibre Channel Interface . . . . .	3-9

## Chapter 4. Installation and Configuration . . . . . 4-1

Using the Library Configuration Form . . . . .	4-1
Installing Your Library . . . . .	4-1
Choosing a Location . . . . .	4-1
Unpacking the Library . . . . .	4-2
Verifying the Shipment . . . . .	4-2
Installing the Library Foot Pads (for Desktop	
Installation ONLY) . . . . .	4-3
Removing and Storing the Shipping Lock . . . . .	4-4
Rackmounting the Library (for Rack Installation	
ONLY) . . . . .	4-6
Connecting the Host Interface Cable . . . . .	4-11
Connecting a Power Cord . . . . .	4-13
Configuring Your Library . . . . .	4-14
Choosing Your Configuration Method . . . . .	4-14
Using Factory Defaults as Your Configuration	
Configuring Your Library using the Web User	
Interface . . . . .	4-15
Configuring Your Library using the Operator	
Control Panel . . . . .	4-31
Preparing the Host . . . . .	4-31
Verifying the Connection . . . . .	4-32
Cartridge Magazines . . . . .	4-32
Populating the Library with Data Cartridges . . . . .	4-36
Inserting the Cleaning Cartridge . . . . .	4-37

## Chapter 5. Operations . . . . . 5-1

Operator Control Panel Navigation . . . . .	5-7
Operator Control Panel Menu Tree . . . . .	5-9
Monitor Menu . . . . .	5-10
Control Menu . . . . .	5-16
Configure Menu . . . . .	5-18
Service Menu . . . . .	5-30
Web User Interface Menus . . . . .	5-33
Monitor Library Menu . . . . .	5-34
Manage Library Menu . . . . .	5-42
Configure Library Menu . . . . .	5-44
Service Library Menu . . . . .	5-57
Import and Export Media during Normal Library	
Operation . . . . .	5-64
Configuring I/O Stations and Reserving Slots . . . . .	5-65

<b>Chapter 6. Using Ultrium Media . . . . .</b>	<b>6-1</b>
Data Cartridges . . . . .	6-1
Cartridge Compatibility . . . . .	6-2
WORM (Write Once, Read Many). . . . .	6-3
WORM Media . . . . .	6-3
Data Security on WORM Media . . . . .	6-3
WORM Media Errors . . . . .	6-3
Cleaning Cartridge. . . . .	6-4
Bar Code Label . . . . .	6-4
Guidelines for Using Bar Code Labels . . . . .	6-5
Write-Protect Switch . . . . .	6-6
Handling the Cartridges . . . . .	6-7
Provide Training . . . . .	6-7
Ensure Proper Packaging . . . . .	6-7
Provide Proper Acclimation and Environmental Conditions . . . . .	6-8
Perform a Thorough Inspection . . . . .	6-8
Handle the Cartridge Carefully . . . . .	6-9
Environmental and Shipping Specifications for Tape Cartridges . . . . .	6-9
<b>Chapter 7. Troubleshooting . . . . .</b>	<b>7-1</b>
Installation Problems . . . . .	7-6
Library Recovery Problem Determination . . . . .	7-6
Procedures for Isolating CRU Problems . . . . .	7-7
Isolating a Power Supply Problem . . . . .	7-7
Isolating Drive Sled Problems . . . . .	7-9
Isolating a Library Controller Card vs. Accessor Enclosure Problem . . . . .	7-10
Isolating Web User Interface Problems . . . . .	7-11
Isolating Accessor Scanner Problems . . . . .	7-11
Isolating Host Attachment Interface Problems . . . . .	7-12
Identifying a Suspect Cartridge . . . . .	7-12
<b>Chapter 8. Error Codes . . . . .</b>	<b>8-1</b>
<b>Chapter 9. Service Procedures . . . . .</b>	<b>9-1</b>
Removing Cartridges from Magazine Slots. . . . .	9-1
Releasing the Magazines Manually . . . . .	9-1
Using the ITDT Firmware Update, Dump Retrieval and Drive Test Tool . . . . .	9-4
<b>Chapter 10. Check, Adjust, Remove, and Replace . . . . .</b>	<b>10-1</b>
Tools Required. . . . .	10-1
Electrostatic Discharge . . . . .	10-1
Relocating Your Library. . . . .	10-1
Removing/Installing/Adding a Tape Drive Sled . . . . .	10-3
Removing a Tape Drive Sled . . . . .	10-4
Installing a Tape Drive Sled . . . . .	10-6
Adding a Tape Drive Sled . . . . .	10-9
Replacing a Power Supply . . . . .	10-10
Replacing a Library Controller Card . . . . .	10-11
Replacing Cartridge Magazines. . . . .	10-13
Replacing the Library Enclosure . . . . .	10-13

Preparing the Defective Library for Replacement . . . . .	10-13
Unpacking and Preparing the Replacement Library Enclosure . . . . .	10-14
Installing Your Drive(s) in the Replacement Library Enclosure . . . . .	10-16
Power Supplies . . . . .	10-18
Library Controller Card . . . . .	10-19
Swapping Cartridge Magazines. . . . .	10-20
Installing the Replacement Library Enclosure Completing the Installation of the Replacement Library Enclosure . . . . .	10-22
Returning the Defective Library Enclosure . . . . .	10-24

<b>Appendix A. SCSI Element Types, SCSI Addresses, and Physical Configurations . . . . .</b>	<b>A-1</b>
2U Library I/O Slot, Storage Slots and Drive Slot Element Addresses and Physical Locations . . . . .	A-1
4U Library I/O Slots, Storage Slots, and Drive Slots Element Addresses and Physical Locations . . . . .	A-2
Library Partitioning and Element Addressing . . . . .	A-3

<b>Appendix B. TapeAlert Flags . . . . .</b>	<b>B-1</b>
TapeAlert Flags Supported by the Library . . . . .	B-1
TapeAlert Flags Supported by the Drive . . . . .	B-2

<b>Appendix C. Sense Data. . . . .</b>	<b>C-1</b>
Library Sense Data . . . . .	C-1
Drive Sense Data . . . . .	C-6

<b>Appendix D. Enabling LUN Support in Linux . . . . .</b>	<b>D-1</b>
Red Hat Enterprise Linux . . . . .	D-2
Enabling LUN Support in Netware . . . . .	D-2

<b>Appendix E. Notes on IPv6 Compatibility with Windows 2003/XP and 2008/Vista . . . . .</b>	<b>E-1</b>
Notes on IPv6 Compatibility with Linux . . . . .	E-2

<b>Appendix F. SNMP Status MIB Variables and Traps. . . . .</b>	<b>F-1</b>
---	------------

<b>Appendix G. Library Configuration Form . . . . .</b>	<b>G-1</b>
---	------------

<b>Appendix H. Accessibility . . . . .</b>	<b>H-1</b>
--	------------

<b>Glossary . . . . .</b>	<b>I-1</b>
---------------------------	------------

<b>Index . . . . .</b>	<b>X-1</b>
------------------------	------------



## Figures

1-1.	Front panel of a 2U library . . . . .	1-1	4-20.	The 4U library Configure Library: Logical Libraries page . . . . .	4-21
1-2.	Front panel of a 4U library . . . . .	1-2	4-21.	The Configure Library: Path Failover Feature Activation screen. . . . .	4-21
1-3.	Rear panel of a 2U library with a SCSI drive	1-3	4-22.	Feature Key verification screen. . . . .	4-22
1-4.	Rear panel of a 4U library with full height Fibre Channel drive and half height SCSI and SAS drives . . . . .	1-4	4-23.	Feature Activation Key screen . . . . .	4-22
1-5.	Rear panel of a 2U library with a full height dual port SAS drive. . . . .	1-4	4-24.	Configure Library: Encryption Activation screen . . . . .	4-23
1-6.	Library drive sled without ESD springs (SCSI sled shown) . . . . .	1-10	4-25.	The Configure Library: Drive screen	4-24
1-7.	Library drive sled with ESD springs [1] (SAS sled shown) . . . . .	1-10	4-26.	Configure Library: Network Page	4-25
2-1.	Power-ON screens . . . . .	2-2	4-27.	Warning Screen . . . . .	4-26
2-2.	Web User Interface login page . . . . .	2-6	4-28.	The Configure Library: User Access screen	4-27
2-3.	2U library System Status screen . . . . .	2-6	4-29.	The Configure Library: Date and Time screen . . . . .	4-28
2-4.	4U library System Status screen . . . . .	2-6	4-30.	The Configure Library: Logs and Traces screen . . . . .	4-28
2-5.	4U library System Status screen showing media attention status . . . . .	2-7	4-31.	The Configure Library: Email Notification screen . . . . .	4-29
2-6.	4U library System Status screen showing a power supply failure . . . . .	2-7	4-32.	Configure Library: SNMP Page	4-30
3-1.	Configuration of a one - partition system	3-4	4-33.	2U library left magazine . . . . .	4-33
3-2.	Configuration of a two - partition system	3-4	4-34.	2U library right magazine . . . . .	4-33
3-3.	Configuration of a three - partition system	3-5	4-35.	2U library I/O Station in the left magazine	4-34
3-4.	Configuration of a four - partition system	3-5	4-36.	4U library left magazines. . . . .	4-34
3-5.	Examples of SCSI element addressing	3-6	4-37.	4U library right magazines . . . . .	4-35
4-1.	Installing foot pads on the bottom of the library enclosure . . . . .	4-4	4-38.	4U library I/O Station in the lower left magazine . . . . .	4-35
4-2.	Shipping lock and label . . . . .	4-5	4-39.	Finger Holes on back side of 4U library I/O Station . . . . .	4-36
4-3.	Library shipping lock and label storage location . . . . .	4-5	5-1.	2U Library Control Keys . . . . .	5-8
4-4.	Rack Kit mounting hardware. . . . .	4-7	5-2.	4U Library Control Keys . . . . .	5-8
4-5.	Examples of EIA units for round hole and square hole installations . . . . .	4-7	5-3.	Operator Control Panel Menu Tree	5-10
4-6.	Rear view of a rack showing the narrow part of the rail. . . . .	4-8	5-4.	Monitor: Library menu . . . . .	5-11
4-7.	2U library side screws to remove . . . . .	4-8	5-5.	Monitor: Drive menu . . . . .	5-13
4-8.	2U library rack anchors and mounting brackets . . . . .	4-9	5-6.	Example of a 4U Monitor: Inventory menu	5-15
4-9.	Sliding the 2U library into the rack	4-9	5-7.	Overview of inventoried cartridges: Lower Left Magazine of a 4U Library . . . . .	5-15
4-10.	Sliding the 4U library into the rack	4-10	5-8.	Detailed information on cartridges residing in a magazine . . . . .	5-16
4-11.	Securing the 2U library to the rack	4-10	5-9.	Control: I/O Station menu . . . . .	5-16
4-12.	Securing the 4U library to the rack	4-11	5-10.	Control: Move Cartridges menu	5-17
4-13.	Attaching a SCSI host interface cable to the 2U library. . . . .	4-12	5-11.	Control: Magazine menu . . . . .	5-17
4-14.	Attaching host interface cables to the 4U library . . . . .	4-12	5-12.	Control: Re-Inventory menu. . . . .	5-18
4-15.	Attaching a SAS interface cable to the 2U library . . . . .	4-12	5-13.	Configure: Logical Libraries menu	5-19
4-16.	Removing the protective label from the power receptacle . . . . .	4-13	5-14.	Configure: Library menu . . . . .	5-20
4-17.	Log in screen on the Web User Interface	4-18	5-15.	Configure: Drive menu . . . . .	5-23
4-18.	The 2U library Configure Library: General screen . . . . .	4-20	5-16.	Configure: Network menu . . . . .	5-24
4-19.	Example: The 4U library Configure Library: General screen . . . . .	4-20	5-17.	Configure: Set Access PIN menu	5-26
			5-18.	Pound sign (#) shows accessible menus when access PIN is enabled but before it is entered. . . . .	5-27
			5-19.	Configure: Save/Restore menu . . . . .	5-27
			5-20.	Configure: Set Date and Time menu	5-29
			5-21.	Configure: Path Failover . . . . .	5-30
			5-22.	Service: Library Verify menu . . . . .	5-30
			5-23.	Service: Run Tests menu . . . . .	5-31
			5-24.	Service: Service menu . . . . .	5-32

5-25.	Service: Display Contrast menu	5-33	6-6.	Checking for gaps in the seams of a cartridge	6-9
5-26.	The 4U library Monitor Library: Library Identity page.	5-35	7-1.	A 250w power supply with LEDs	7-7
5-27.	The 4U library Monitor Library: Drive Identity page showing one Ultrium 3 SAS half high V2 drive (#1) and one Ultrium 4 SAS half high drive (#2)	5-37	7-2.	A 80w power supply without LEDs	7-8
5-28.	The 4U library Monitor Library: Library Status page	5-38	9-1.	Access holes for the left magazine	9-1
5-29.	The 4U library Monitor Library: Drive Status page	5-40	9-2.	Access holes for the right magazine	9-2
5-30.	The 2U library Monitor Library: Inventory page	5-41	9-3.	Left magazine pulled out of the 2U library	9-3
5-31.	The 4U library Monitor Library: Inventory page	5-42	9-4.	Left Magazines pulled out of the 4U Library	9-3
5-32.	Manage Library: Move Media page	5-43	10-1.	ESD label	10-1
5-33.	Manage Library: Perform Inventory page	5-43	10-2.	Shipping Lock and Label Storage Location	10-2
5-34.	Manage Library: Release Magazine page	5-43	10-3.	Shipping Lock and Label.	10-2
5-35.	The 4U library Configure Library: General and Extended page.	5-45	10-4.	Library drive sled without ElectroStatic Discharge (ESD) springs (SCSI sled shown)	10-3
5-36.	The 4U library Configure Library: Logical Libraries page	5-46	10-5.	Library drive sled with ESD springs [1] (SAS sled shown)	10-4
5-37.	The 4U library Configure Library: Path Failover page	5-46	10-6.	Drive sled components (full-high fibre drive in top position, half-high SCSI drive in middle position, half-high SAS drive in bottom position) on back panel of a 4U library	10-5
5-38.	Path Failover license verification page	5-46	10-7.	Pulling the drive sled out of the library (drive sled without ESD springs shown)	10-6
5-39.	Feature Activation Key screen	5-47	10-8.	Pushing the drive sled into the library (drive sled without ESD springs shown)	10-7
5-40.	Configure Library: Encryption Feature configuration screen	5-48	10-9.	Diagrams for applying conductive tape for ESD protection to the back of a drive sled installed in a 2U or 4U library	10-8
5-41.	The Configure Library: Drives page for a 2U library.	5-50	10-10.	A power supply being removed from a 2U library	10-11
5-42.	The Configure Library: Drives page for a 4U library.	5-50	10-11.	A Library Controller Card being removed from the library	10-12
5-43.	Configure Library: Network Page	5-51	10-12.	Removing the two mounting bracket screws anchoring the library to the rack (one screw on each side of the library)	10-14
5-44.	Warning Screen	5-52	10-13.	Foot pads installed on the bottom of the library enclosure	10-15
5-45.	Configure Library: User Access page	5-53	10-14.	Removing the shipping label and lock from the top of the library and storing on the rear panel	10-16
5-46.	The Configure Library: Date & Time page	5-54	10-15.	Library shipping lock and label storage location on the rear panel of the library	10-16
5-47.	Configure Library: Logs & Traces page	5-54	10-16.	Removing a drive sled from the library (drive sled without ESD springs shown)	10-17
5-48.	Configure Library: Email Notification page	5-55	10-17.	Drive sled taping diagrams	10-18
5-49.	Configure Library: SNMP Page	5-56	10-18.	A power supply being removed from a library	10-19
5-50.	Configure Library: Save/Restore page	5-57	10-19.	Removing a Library Controller Card from the library	10-20
5-51.	No Cleaning Required	5-58	10-20.	Access hole for the left magazine (facing rear of library)	10-20
5-52.	No Cleaning Cartridge in Library	5-58	10-21.	Access hole for the right magazine (facing rear of library)	10-21
5-53.	Service Library: Clean Drive page	5-58	10-22.	Left magazines pulled out of a 4U library (facing front of library)	10-22
5-54.	Service Library: View Logs page	5-59	10-23.	Mounting brackets and anchors for securing the library in a rack (one bracket and anchor on each side of the library).	10-23
5-55.	Service Library: View Drive Logs screen	5-60	10-24.	Front view of rack showing screw placement	10-23
5-56.	Service: Save Drive Dump	5-60	A-1.	Configuration of a one - partition system	A-4
5-57.	Service Library: Perform Diagnostics page	5-61	A-2.	Configuration of a two - partition system	A-5
5-58.	Service Library: Perform Key Path Diagnostics page	5-62			
5-59.	The Service Library: Upgrade Firmware page showing one Ultrium 3 SAS Half High V2 drive and one Ultrium 4 SAS Half High drive.	5-63			
5-60.	Service Library: Reboot page	5-64			
6-1.	The LTO Ultrium 1500 GB Data Cartridge	6-1			
6-2.	Ultrium Data and WORM Tape Cartridges	6-3			
6-3.	Sample bar code label on the LTO Ultrium 5 Tape Cartridge	6-5			
6-4.	Setting the write-protect switch	6-6			
6-5.	Double-boxing tape cartridges for shipping	6-8			

A-3.	Configuration of a three - partition system	A-5	A-5.	Examples of SCSI element addressing	A-6
A-4.	Configuration of a four - partition system	A-6			



## Tables

1.	Minimum Firmware Levels for common Library features . . . . .	iii	5-12.	Drive Identity page elements . . . . .	5-49
1-1.	2U library and 4U library front panel descriptions . . . . .	1-2	6-1.	Nominal Cartridge Life: Load/Unload Cycles . . . . .	6-2
1-2.	2U library and 4U library rear panel descriptions . . . . .	1-5	6-2.	Ultrium data cartridge compatibility with Ultrium tape drive . . . . .	6-2
1-3.	Tape drive model and host interface type	1-8	6-3.	Cartridges and VOLSERs compatible with the Ultrium Tape Drives . . . . .	6-4
1-4.	Library storage capacity and data transfer rate . . . . .	1-8	6-4.	Location of the write-protect switch	6-6
1-5.	Physical Specifications. . . . .	1-11	6-5.	Environment for operating, storing, and shipping the LTO Ultrium Tape Cartridge	6-10
1-6.	Power Specifications . . . . .	1-12	7-1.	Troubleshooting table . . . . .	7-1
1-7.	Operation Specifications: Ultrium 5	1-12	7-2.	Power Supply LED Meanings . . . . .	7-8
1-8.	Operation Specifications: Ultrium 4	1-12	8-1.	Main Error Codes . . . . .	8-2
1-9.	Operation Specifications: Ultrium 3	1-13	8-2.	Sub error codes . . . . .	8-7
1-10.	Environmental Specifications . . . . .	1-13	8-3.	Warning Events . . . . .	8-11
3-1.	Host Drive Interface Support. . . . .	3-7	10-1.	Shipping Lock/Shipping Label. . . . .	10-2
3-2.	Maximum bus length between terminators	3-8	A-1.	2U library SCSI Element Types and Element Addresses . . . . .	A-1
3-3.	Recommended maximum quantity of drives per SCSI bus . . . . .	3-8	A-2.	4U library SCSI Element Types and Element Addresses . . . . .	A-1
4-1.	Location criteria . . . . .	4-1	A-3.	2U library SCSI element addresses for storage slots and drive slot (one logical partition with one drive) . . . . .	A-2
5-1.	Menu navigation shortcuts . . . . .	5-1	A-4.	4U library SCSI element addresses for storage slots and drive slot (one logical partition with drives in slot 1 and slot 2) . . . . .	A-2
5-2.	Library Control Keys . . . . .	5-8	B-1.	TapeAlert Flags Supported by the Ultrium Tape Drive. . . . .	B-2
5-3.	Detailed information on cartridges residing in a magazine . . . . .	5-16	C-1.	Library Sense Keys, ASC and ASCQ	C-1
5-4.	Factory Default Settings . . . . .	5-28	C-2.	LTO Tape Drive Sense Data . . . . .	C-6
5-5.	Web User Interface Menus . . . . .	5-33	F-1.	SNMP Status Events . . . . .	F-1
5-6.	Library Identity page elements. . . . .	5-34			
5-7.	Drive Identity page elements . . . . .	5-35			
5-8.	Library Status page elements . . . . .	5-37			
5-9.	Drive Status page elements . . . . .	5-38			
5-10.	Configure Library: General page elements	5-44			
5-11.	Configure Library: Specific page elements	5-44			



---

## Safety and Environmental Notices

When using this product, observe the danger, caution, and attention notices that are contained in this guide. The notices are accompanied by symbols that represent the severity of the safety condition.

The sections that follow define each type of safety notice and give examples.

---

### Danger Notice



A danger notice calls attention to a situation that is potentially lethal or extremely hazardous to people. A lightning bolt symbol always accompanies a danger notice to represent a dangerous electrical condition.

---

### Caution Notice

A caution notice calls attention to a situation that is potentially hazardous to people because of some existing condition. A caution notice can be accompanied by one of several symbols:

**If the symbol is...** **It means....**



A hazardous electrical condition with less severity than electrical danger.



A generally hazardous condition not represented by other safety symbols.



**Class I**

A hazardous condition due to the use of a laser in the product. Laser symbols are always accompanied by the classification of the laser as defined by the U. S. Department of Health and Human Services (for example, Class I, Class II, and so forth).



A hazardous condition due to mechanical movement in or around the product.



A hazardous condition due to the weight of the unit. Weight symbols are accompanied by an approximation of the product's weight.



A hazardous condition due to the unit's susceptibility to electrostatic discharge.

---

## Laser Safety and Compliance

Before using the library, review the following laser safety information.

### Class I Laser Product

The library may contain a laser assembly that complies with the performance standards set by the U.S. Food and Drug Administration for a Class I laser product. Class I laser products do not emit hazardous laser radiation. The library has the necessary protective housing and scanning safeguards to ensure that laser radiation is inaccessible during operation or is within Class I limits. External safety agencies have reviewed the library and have obtained approvals to the latest standards as they apply.

---

## Performing the Safety Inspection Procedure

Before you service the unit, perform the following safety inspection procedure:

1. Stop all the activities between the host and the library's tape drives.
2. Turn off the power to the library by pushing in on the **Power** button (1) shown in Figure 1-1 on Page 1-1 for 4 seconds.
3. If drives are SCSI attached, disconnect the SCSI cable and check the SCSI bus terminator for damage.
4. Unplug the library's power cord or cords from the electrical outlet and the library power supply.
5. Check the library's power cord for damage, such as a pinched, cut, or frayed cord.
6. If drives are SCSI attached, check the tape drive's SCSI bus (signal) cable for damage.
7. If drives are FC/SAS attached, check the tape drive's FC/SAS cable for damage.
8. Check the cover of the library for sharp edges, damage, or alterations that expose its internal parts.
9. Check the cover of the library for proper fit. It should be in place and secure.
10. Check the product label at the rear of the library to make sure that it matches the voltage at your outlet.



## Rack Safety

The following general safety information should be used for all rack mounted devices.



### DANGER

- Always lower the leveling pads on the rack cabinet.
- Always install stabilizer brackets on the rack cabinet.
- To avoid hazardous conditions due to uneven mechanical loading, always install the heaviest devices in the bottom of the rack cabinet. Always install servers and optional devices starting from the bottom of the rack cabinet.
- Rack mounted devices are not to be used as a shelf or work space. Do not place any object on top of rack mounted devices.
- Each rack cabinet might have more than one power cord. Ensure that all power cords in the rack cabinet are disconnected before servicing any device in the rack cabinet.
- Connect all devices installed in a rack cabinet to power devices installed in the same rack cabinet. Do not plug a power cord from a device installed in one rack cabinet into a power device installed in a different rack cabinet.
- An electrical outlet that is not correctly wired could place hazardous voltage on the metal parts of the system or the devices that attach to the system. It is the responsibility of the customer to ensure that the outlet is correctly wired and grounded to prevent an electrical shock.



**CAUTION:**

- Do not install a unit in a rack where the internal rack ambient temperatures **WILL** exceed the manufacturer's recommended ambient temperature for all your rack mounted devices.
- Do not install a unit in a rack where the air flow is compromised. Ensure that air flow is not blocked or reduced on any side of the unit.
- Connect the equipment to the supply circuit such that overloading of the circuits does not compromise the supply wiring or overcurrent protection. To provide the correct power connection to a rack, refer to the rating labels located on the equipment in the rack to determine the total power requirement of the supply circuit.
- *(For sliding drawers)* Do not pull out or install any drawer or feature if the rack stabilizer brackets are not attached to the rack. Do not pull out more than one drawer at a time. The rack may become unstable if you pull out more than one drawer at a time.
- *(For fixed drawers)* Do not move a fixed drawer. Attempting to move the drawer partially or completely out of the rack may cause the rack to become unstable or cause the drawer to fall out of the rack.



**CAUTION:**

Removing components from the upper positions in the rack cabinet improves rack stability during relocation. Follow the general guidelines as listed below whenever you relocate a populated rack cabinet within a room or building:

- Reduce the weight of the rack cabinet by removing equipment starting at the top of the rack cabinet. When possible, restore the rack cabinet to the configuration of the rack cabinet as you received it. If this configuration is not known, you must do the following:
  - Remove all devices in the 32U position and above.
  - Ensure that the heaviest devices are installed in the bottom of the rack cabinet.
  - Ensure that there are no empty U-levels between devices installed in the rack cabinet below the 32U level.
- If the rack cabinet you are relocating is part of a suite of rack cabinets, detach the rack cabinet from the suite.
- Inspect the route that you plan to take to eliminate potential hazards.
- Verify the route that you choose can hold the weight of the loaded rack cabinet. Refer to the documentation that comes with your rack cabinet for the weight of a loaded rack cabinet.
- Verify that all door openings are at least 762 x 2032 mm (30 x 80 inches).
- Ensure that all devices, shelves, drawers, doors, and cables are secure.
- Ensure that the four leveling pads are raised to their highest position.
- Ensure that there is no stabilizer bracket installed on the rack cabinet during movement.
- Do not use a ramp inclined at more than ten degrees.
- Once the rack cabinet is in the new location, do the following:
  - Lower the four leveling pads.
  - Install stabilizer brackets on the rack cabinet.
  - If you remove any of the devices from the rack cabinet, repopulate the rack cabinet from the lowest position to the highest position.
- If a long distance relocation is required, restore the rack cabinet to the configuration of the rack cabinet as you received it. Pack the rack cabinet in the original packaging material, or equivalent. Also lower the leveling pads to raise the casters off of the pallet and bolt the rack cabinet to the pallet.



---

## Preface

This manual contains information and instructions necessary for the installation, operation, and service of the Dell™ PowerVault™ TL2000 Tape Library and TL4000 Tape Library.

---

## Related Publications

Refer to the following publications for additional information.

- *Dell™ PowerVault™ TL2000 Tape Library and TL4000 Tape Library Getting Started Guide* provides installation information.
- *Dell™ PowerVault™ TL2000 Tape Library and TL4000 Tape Library SCSI Reference* provides supported SCSI commands and protocol governing the behavior of SCSI interface.



---

## Chapter 1. Product Description

The Dell™ PowerVault™ TL2000 Tape Library (2U library) and the Dell PowerVault TL4000 Tape Library (4U library) provide compact, high-capacity, low-cost solutions for simple, unattended data backup. The 4U library houses up to 48 tape cartridges (or 45 and an elective 3-slot I/O Station) in a compact 4U form factor with easy access to cartridges via four removable magazines. The 2U library houses up to 24 tape cartridges (or 23 and an elective 1-slot I/O Station) in a compact 2U form factor with easy access to cartridges via two removable magazines.

The TL2000/TL4000 Library supports LTO 3 tape drives with these interfaces: a Small Computer Systems Interface (SCSI), SAS, Fibre Channel interface (FC). LTO 4 and LTO 5 drives are Serial Attached SCSI interface (SAS), and Fibre Channel (FC) only.

---

### Front Panel

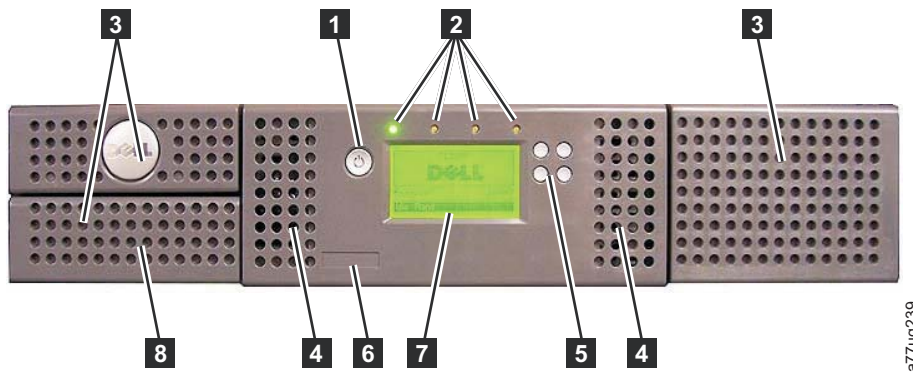

Figure 1-1. Front panel of a 2U library

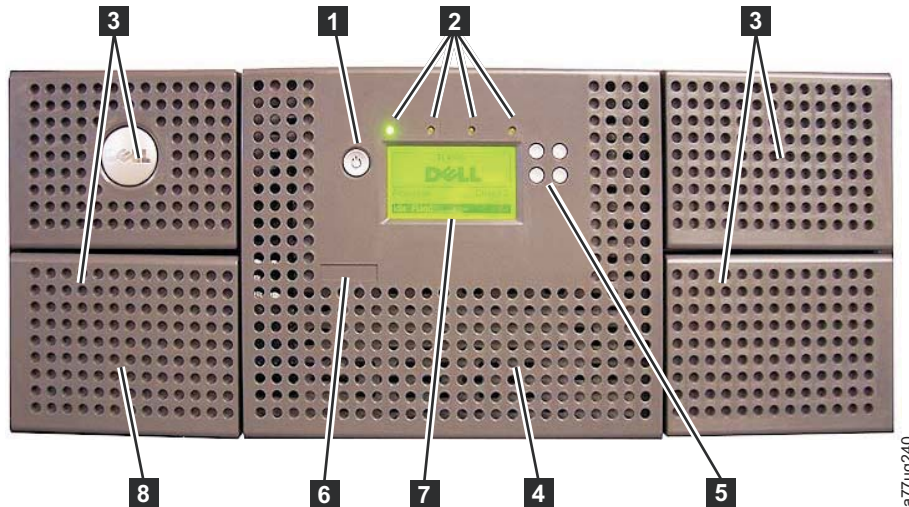

Figure 1-2. Front panel of a 4U library

Table 1-1 below contains front panel descriptions for both the 2U library in Figure 1-1 on page 1-1 and the 4U library in Figure 1-2.

Table 1-1. 2U library and 4U library front panel descriptions

Number	Item	Description
<b>1</b>	Power button	Pressing this button powers ON the library. Pressing and holding this button for 4 seconds will power OFF the unit (soft power down). No power switch or button can be found on the back panel of the library.
<b>2</b>	Front panel LEDs (left to right)	<ul style="list-style-type: none"> <li>• <b>Ready/Activity</b> (Green LED) - It is illuminated any time the unit is powered ON and able to function. It should blink whenever there is library or drive activity, or when the library is in the process of powering up.</li> <li>• <b>Clean Drive</b> (Amber LED) - It is illuminated when the drive needs to be cleaned. The LED will be turned OFF after the drive is cleaned successfully.</li> <li>• <b>Attention</b> (Amber LED) - It is illuminated when there has been a failure that indicates a piece of media is bad, marginal, or invalid. It will be cleared when all invalid cartridges have been exported from the library. The amber LED may also be lit because a power supply or a power supply fan is failing, or a drive sled is defective, missing, or has been replaced by a different drive type.</li> <li>• <b>Error</b> (Amber LED) - It is illuminated when there is an unrecoverable library or drive failure. A message is displayed at the same time on the Operator Control Panel display.</li> </ul>
<b>3</b>	Cartridge magazines	<ul style="list-style-type: none"> <li>• The 2U library contains two cartridge magazines. <ul style="list-style-type: none"> <li>– The left magazine can hold up to 12 cartridges (or 11 data cartridges and the elective 1-slot I/O Station.)</li> <li>– The right magazine can hold up to 12 cartridges.</li> </ul> </li> <li>• The 4U library contains four cartridge magazines. <ul style="list-style-type: none"> <li>– The upper left magazine can hold up to 12 cartridges.</li> <li>– The lower left magazine can hold up to 12 cartridges (or 9 data cartridges and the elective 3-slot I/O Station.)</li> <li>– The upper right magazine can hold up to 12 cartridges.</li> <li>– The lower right magazine can hold up to 12 cartridges.</li> </ul> </li> </ul>
<b>4</b>	Air vents	These vents draw cooler air into the library enclosure and allow warm air to escape, which helps keep the library at a normal operating temperature.



Table 1-1. 2U library and 4U library front panel descriptions (continued)

Number	Item	Description
5	Control keys	<ul style="list-style-type: none"> <li>• UP (Λ) - The upper left button is used to scroll upward through menu items.</li> <li>• DOWN (v) - The lower left button is used to scroll downward through menu items.</li> <li>• CANCEL (X) - The upper right button is used to cancel a user action and return to the previous menu screen.</li> <li>• SELECT (v) - The lower right button is used to display a sub-menu or force an accessor action.</li> </ul>
7	Operator Control Panel display	This component is a 128 X 64 monochrome graphic display.
8	I/O Station	<p>The Input/Output (I/O) Station is used to import and export cartridges into and out of the library.</p> <ul style="list-style-type: none"> <li>• The 2U library has an elective 1-slot I/O Station.</li> <li>• The 4U library has an elective 3-slot I/O Station.</li> </ul>

## Rear Panel

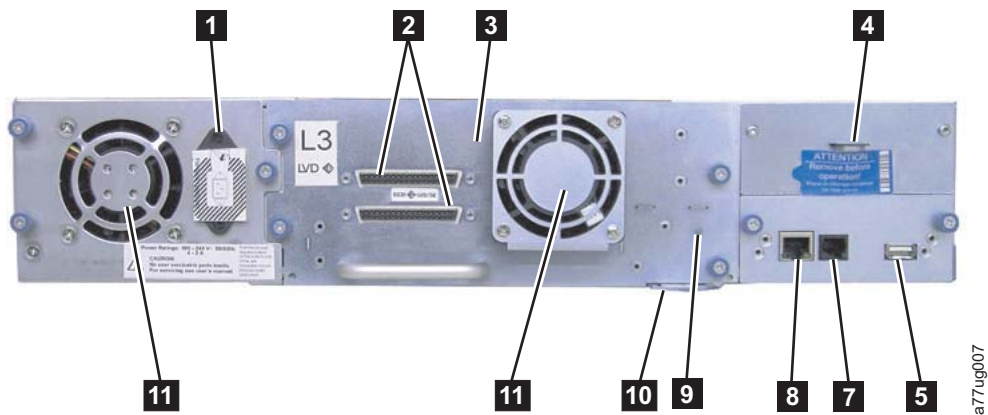
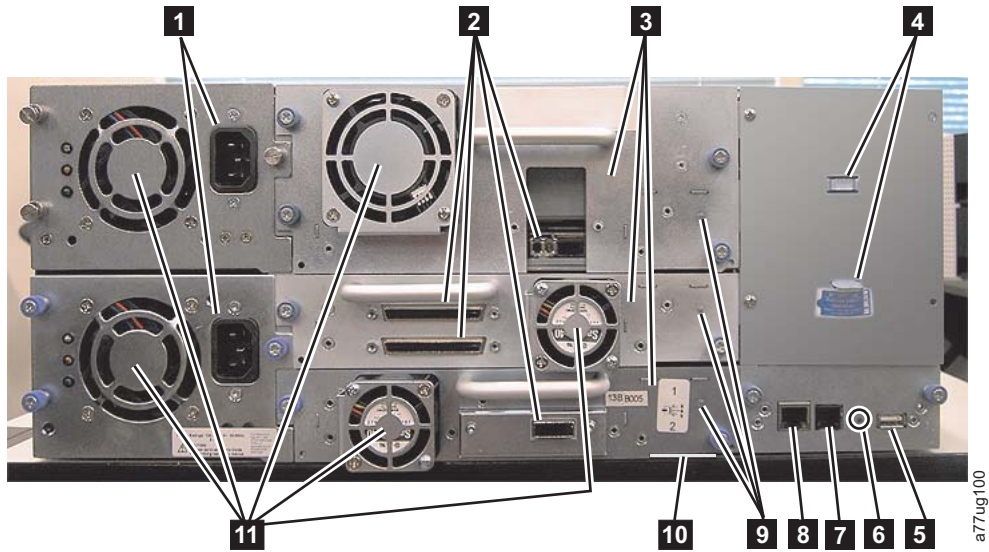
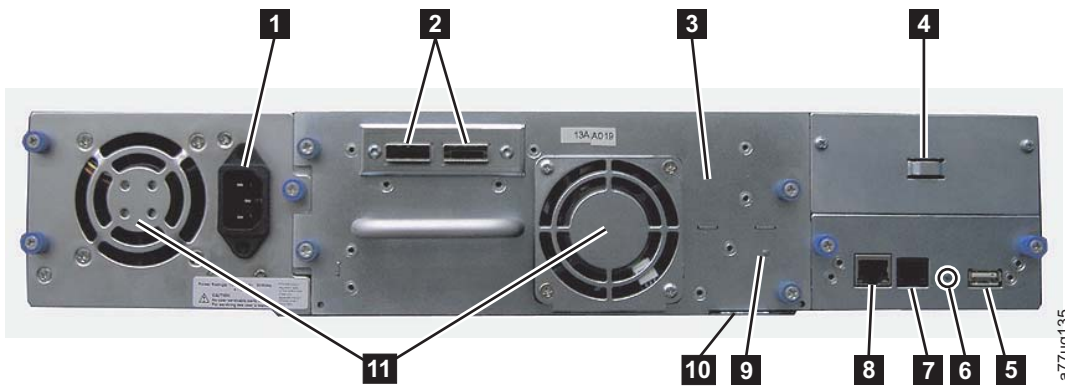

Figure 1-3. Rear panel of a 2U library with a SCSI drive



a77ug100

Figure 1-4. Rear panel of a 4U library with full height Fibre Channel drive and half height SCSI and SAS drives. The configuration shown in this figure is used as an example only. This configuration is not recommended. Half height SCSI drives are not supported on the TL2000/TL4000.



a77ug135

Figure 1-5. Rear panel of a 2U library with a full height dual port SAS drive

Table 1-2. 2U library and 4U library rear panel descriptions

Number	Item	Description
<b>1</b>	Power connector(s)	Both libraries require a 110/220 volt AC power connection. <ul style="list-style-type: none"> <li>• The 2U library has one power supply.</li> <li>• The 4U library has a minimum of one power supply, but has the capability of adding a redundant power supply.</li> </ul>
<b>2</b>	Host interface connectors	The library has one or more of the following host interface connectors on the drive sled: <ul style="list-style-type: none"> <li>• a 68-pin HD SCSI connector</li> <li>• a Fibre Channel connector</li> <li>• a SFF-8088 mini-SAS connector</li> </ul>
<b>3</b>	Tape drive sled	This library supports the Ultrium 3 and Ultrium 4 tape drive. The tape drive in the library is packaged in a container called a drive sled. Drive sleds come in a full height or half height configuration. The drive sled is a customer replaceable unit (CRU), and is hot-pluggable, which is designed for easy removal and replacement.
<b>4</b>	Shipping lock and label storage location	The shipping lock, which secures the accessor during shipping, and associated label are stored on the rear panel of the library for future use. See “Removing and Storing the Shipping Lock” on page 4-4. <b>Note:</b> The shipping lock must be removed before powering ON the library to allow the accessor to function properly.
<b>5</b>	USB port	Used to save/restore library configuration information on a USB device.
<b>6</b>	Library Control Board (LCC) LED	An LED showing the status of the Library Control Board.  LED flashing (1 flash per second) - normal operation
<b>7</b>	Serial port	This port is used to communicate serially with the library using an RJ-11 connector. For use by Service Personnel.
<b>8</b>	Ethernet port	This port is used to connect the library to a network.  <b>LED</b> <ul style="list-style-type: none"> <li>• <i>10/100 Link</i> <ul style="list-style-type: none"> <li>– <b>Description:</b> Green: Link Integrity</li> <li>– <b>Flashing:</b> Network synchronization/negotiation</li> <li>– <b>Steady (On):</b> Good connection</li> <li>– <b>Off:</b> No connection between NIC and hub</li> </ul> </li> <li>• <i>Activity</i> <ul style="list-style-type: none"> <li>– <b>Description:</b> Amber: Port traffic indicator</li> <li>– <b>Flashing:</b> Network traffic present</li> <li>– <b>Steady (On):</b> Heavy network traffic</li> <li>– <b>Off:</b> No traffic</li> </ul> </li> </ul>
<b>9</b>	Tape drive LED	This LED indicates the current status of the drive. When the LED is green, it indicates normal drive activity.
<b>10</b>	Service Tag/Serial Number	The service tag and serial number on the pull-out label links the library to your warranty.
<b>11</b>	Fan vents	These vents allow air to escape from the power supply and tape drive sled.

---

## Bar Code Reader

The bar code reader is an integral part of the library accessor. The bar code reader provides inventory feedback to the host application, Operator Control Panel display, and Web User Interface by reading cartridge bar code labels. The library stores the customized inventory data in memory.

Library firmware supports a 6 or 8 character volume serial number (VOLSER) on the bar code label on the tape cartridge. Bar code selection is available for libraries with library code 4.50 or greater.

---

## Encryption

The LTO Ultrium 5 Tape Drive supports Application Managed Encryption (AME), and Library Managed Encryption (LME), using T10 encryption methods, for SAS and Fibre Channel drives only. Data encryption is supported with LTO Ultrium 4 and Ultrium 5 Data Cartridges only. Encryption is also supported with library firmware version 5.80 and higher and drive firmware version 77BE for LTO 4 and higher drive code level.

The encryption enabled drive contains the necessary hardware and firmware to encrypt and decrypt host tape application data. Encryption policy and encryption keys are provided by the host application or host server. A drive digital certificate is installed at manufacturing time. Each drive receives a unique serial number and certificate. The T10 application may validate each drive instance by checking the drive's digital certificate.



**CAUTION:**

The library must be offline from any user and all media must be removed from the drives before license keys are installed or any configuration modifications are made. Please refer to "Power ON/OFF" on page 2-4 and "Removing Cartridges from Magazine Slots" on page 9-1 for instructions to take the library offline and to eject media from the drives.

To prevent possible data loss due to an EKM server failure, Dell recommends the use of a primary and secondary EKM server. This configuration provides redundancy in the event the primary EKM server is down or unavailable. Please refer to Chapter 2 (Multiple Key Managers for Redundancy) of the Dell Encryption Key Manager User's Guide and to "Configure Library: Encryption" on page 5-47 for information on configuring a primary and secondary EKM for your library.

If the backup job fails due to an EKM server failure, the job recovers if connectivity is restored to the EKM server prior to expiration of the timeout set in the tape backup software application.

Enabling library-managed encryption on a PowerVault TL2000 or TL4000 is a 6 step process.

1. Upgrade the library and drive firmware to the latest versions. The firmware can be found at <http://support.dell.com>.
2. Enable library-managed encryption on the library via the license key if not already licensed. Please refer to "Configure Library: Encryption" on page 5-47 for activation instructions.

If you purchased library-managed encryption at the time you purchased your library, a hard copy of the license key is provided with your library as a backup. If there are any issues with the license key for library-managed encryption purchased with the library, please visit <http://www.dell.com/tapeautomation> to obtain your license key. You will need the library serial number and worldwide node name to obtain the license key. Please refer to the following tables in this document for instructions on locating this information:

- Table 1.2 for library serial number
- Table 5.6 for library worldwide node name

If this does not resolve your issue, please contact Dell technical support.

3. Configure library-managed encryption on your library. Please refer to “Configure Library: Encryption” on page 5-47 for instructions.
4. Install the Dell Encryption Key Manager (EKM) application on the server designated for EKM. Please refer to Chapter 3.0 of the *Dell Encryption Key Manager User’s Guide* for instructions. This document can be found at <http://support.dell.com>.
5. Configure the EKM application. Please refer to Chapter 4.0 of the *Dell Encryption Key Manager User’s Guide* for instructions.
6. Start the EKM application. Please refer to Chapter 5.0 of the *Dell Encryption Key Manager User’s Guide* for instructions.

**Note:** All encryption settings should be configured or re-verified in the drive after any library or drive reset. This is because a new drive may have been added or an existing drive may have been swapped with another drive.

---

## Supported Internet Protocols

The library supports the following Internet protocols:

- IPv4
- IPv6

To learn more about Internet protocols, visit <http://www.iana.org/>.

---

## SNMP Messaging

Occasionally, the library may encounter a situation that you want to know about, such as an open magazine or a fault that causes the library to stop. The library provides a standard TCP/IP protocol called Simple Network Management Protocol (SNMP) to send alerts about conditions (such as need for operator intervention) over a TCP/IP LAN network to an SNMP monitoring station. These alerts are called SNMP traps. Using the information supplied in each SNMP trap, the monitoring station (together with customer-supplied software) can alert operations personnel of possible problems or operator interventions that occur.

### SNMP Traps

SNMP traps are alerts or status messages that can be collected, monitored and used to proactively manage attached libraries using SNMP protocol with the host server(s). In summary, each trap provides the following information:

- **Product Identification** such as product name, description, manufacturer, model number, firmware level, and the URL that the trap is designated for.
- **Product Status** such as the severity of the trap, status (current and previous) and the time the trap occurred.

- **Library State** (physical device status) such as identification and status of devices that are monitored. In the case of the library, it would include enclosure, power supply, controller, magazine status, drive count, cartridge slot count, and I/O station count. Also included would be certain library statistics, and where appropriate, the fault FSC (fault symptom code) including the severity and description of that fault.
- **Drive Status** such as the identification of each drive in the library, firmware level, serial number and other address and status information.
- **Trap Definitions** such as library status change, open magazine, I/O accessed, hard fault information, drive cleaning requests, excessive retries and library returning to normal operations. For additional information, refer to Appendix G. "SNMP Status MIB Variables and Traps" on page G-1.
- **SNMP MIBs:** The library's Management Information Base (MIB) contains units of information that specifically describe an aspect of the system, such as the system name, hardware number or communications configuration. Status and error data is also gathered by MIBs and sent to one or more IP addresses defined during the SNMP configuration operation. Download the SNMP MIB file for this library from <http://www.support.dell.com>.

## Maximum Library Storage Capacity and Data Transfer Rate

Maximum library storage capacity and maximum data transfer rates are as follows:

Table 1-3. Tape drive model and host interface type

Tape Drive Model	Host Interface
Ultrium 5 drives	<ul style="list-style-type: none"> <li>• 8 Gb/s Fibre Channel - single port</li> <li>• 6 Gb/s SAS - dual port</li> </ul>
Ultrium 4 Full Height drives	<ul style="list-style-type: none"> <li>• 4 Gb/s Fibre Channel - single port</li> <li>• 3 Gb/s Serial Attached SCSI (SAS) - dual port</li> </ul>
Ultrium 4 Half High V2 drives	<ul style="list-style-type: none"> <li>• 8Gb/s Fibre Channel - single port</li> <li>• 6GB/s Serial Attached SCSI (SAS) - dual port</li> </ul>
Ultrium 4 Half Height drives	<ul style="list-style-type: none"> <li>• 3 Gb/s SAS - single port</li> </ul>
Ultrium 3 Full Height drives	<ul style="list-style-type: none"> <li>• Ultra160 SCSI LVD (depending on drive; single-ended (SE) is not recommended as it will severely degrade performance)</li> <li>• 4 Gb/s Fibre Channel - single port</li> </ul>
Ultrium 3 Half High V2 drives	<ul style="list-style-type: none"> <li>• 6GB/s Serial Attached SCSI (SAS) - dual port</li> </ul>
Ultrium 3 Half Height drives	<ul style="list-style-type: none"> <li>• 3 Gb/s SAS - single port</li> </ul>

Table 1-4. Library storage capacity and data transfer rate

Characteristic	2U Library Specification	4U Library Specification
Maximum storage capacity - Ultrium 5 Data Cartridges	<ul style="list-style-type: none"> <li>• 24 data cartridges</li> <li>• Native: 36 TB</li> <li>• Compressed: 72 TB (2:1 compression)</li> </ul>	<ul style="list-style-type: none"> <li>• 48 data cartridges</li> <li>• Native: 72 TB</li> <li>• Compressed: 144 TB (2:1 compression)</li> </ul>
Maximum storage capacity - Ultrium 4 Data Cartridges	<ul style="list-style-type: none"> <li>• 24 data cartridges</li> <li>• Native: 19.2 TB</li> <li>• Compressed: 38.4 TB (2:1 compression)</li> </ul>	<ul style="list-style-type: none"> <li>• 48 data cartridges</li> <li>• Native: 38.4 TB</li> <li>• Compressed: 75.2 TB (2:1 compression)</li> </ul>

Table 1-4. Library storage capacity and data transfer rate (continued)

Characteristic	2U Library Specification	4U Library Specification
Maximum storage capacity - Ultrium 3 Data Cartridges	<ul style="list-style-type: none"> <li>• 24 data cartridges</li> <li>• Native: 9.6 TB</li> <li>• Compressed: 19.2 TB (2:1 compression)</li> </ul>	<ul style="list-style-type: none"> <li>• 48 data cartridges</li> <li>• Native: 19.2 TB</li> <li>• Compressed: 38.4 TB (2:1 compression)</li> </ul>
Sustained native data transfer rate	<p>LTO 3 HH: 60 MBs,</p> <p>LTO3 HH V2: 80 MBs</p> <p>LTO 3 FH: 80 MBs</p> <p>LTO 4 HH and FH: 120 MBs</p> <p>LTO 5 : 140 MBs</p>	

## Ultrium Tape Drives

This library supports the Ultrium 3, Ultrium 4, and Ultrium 5 Tape Drives. Each tape drive in the library is packaged in a container called a drive sled. The drive sled is a customer replaceable unit (CRU), and is designed for quick removal and replacement in the library.

The Ultrium 5 Tape Drive supports two SAS SFF-8088 connectors, or one LC Fibre Channel connector. The SFF-8088 SAS connectors on the Ultrium 5 tape drives are compatible with SAS-1 or SAS-2 cables.

The Ultrium 4 Full Height Tape Drives support SAS, or Fibre Channel interfaces. It features two SFF-8088 SAS connectors, or one LC Fibre Channel connector. The Ultrium 4 Half Height Tape Drive supports one SAS SFF-8088 connector. The Ultrium 4 Half High V2 Tape Drives support two SFF-8088 SAS connectors, or one LC Fibre Channel connector. The SFF-8088 SAS connectors on the Ultrium 4 tape drives are compatible with SAS-1 cables.

The Ultrium 3 Full Height Tape Drive supports LVD Ultra160, or Fibre Channel interfaces. It features two HD68 connectors or one LC Fibre Channel connector. The Ultrium 3 Half Height Drive supports one SAS SFF-8088 connector. The Ultrium 3 Half High V2 Tape Drive supports two SFF-8088 SAS connectors. The SFF-8088 SAS connectors on the Ultrium 3 tape drives are compatible with SAS-1 cables.



a77ug008

Figure 1-6. Library drive sled without ESD springs (SCSI sled shown)

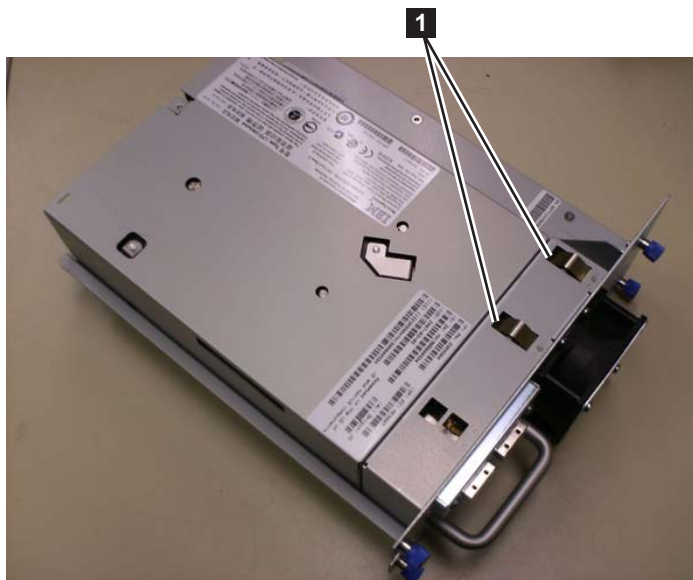

a77ug202

Figure 1-7. Library drive sled with ESD springs [1] (SAS sled shown)

## Speed Matching

To improve system performance, the Ultrium 3, Ultrium 4, and Ultrium 5 Tape Drives use a technique called *speed matching* to dynamically adjust its native (uncompressed) data rate to the slower data rate of the attached server.

## Channel Calibration

The channel calibration feature of the Ultrium 3, Ultrium 4, and Ultrium 5 Tape Drives customizes each read/write data channel for optimum performance. The customization enables compensation for variations in the recording channel transfer function, media characteristics, and read/write head characteristics.



## Power Management

The Ultrium 3, Ultrium 4, and Ultrium 5 Tape Drive's power management function controls the drive's electronics so that part of the electronics completely turn OFF when circuit functions are not needed for the drive's operation.

---

## Media

The library uses Ultrium Tape Cartridges that provide up to 1500 GB native capacity (up to 3000 GB with 2:1 hardware data compression) for LTO 5 tape drives, up to 800 GB native capacity (up to 1600 GB with 2:1 hardware data compression) for LTO-4 tape drives, and up to 400 GB native capacity (up to 800 GB with 2:1 hardware data compression) for LTO-3 tape drives.

Ultrium 5 tape drives can read and write LTO Ultrium 5 Data Cartridges. Ultrium 5 tape drives can read and write LTO Ultrium 4 Data Cartridges at original Ultrium 4 capacities, and can also read LTO Ultrium 3 Data Cartridges with improved data rates. Ultrium 4 tape drives can read and write LTO Ultrium 4 Data Cartridges. Ultrium 4 tape drives can read and write LTO Ultrium 3 Data Cartridges at original Ultrium 3 capacities, and can also read LTO Ultrium 2 Data Cartridges with improved data rates. Ultrium 3 Tape Drives can read and write LTO Ultrium 3 Data Cartridges. Ultrium 3 Tape Drives can read and write LTO Ultrium 2 Data Cartridges at original Ultrium 2 capacities, and can also read LTO Ultrium 1 Data Cartridges with improved data rates of up to 20 MB/second native data transfer rate (40 MB/second with 2:1 compression). Ultrium 4 tape drives cannot read Ultrium 1 tapes. Ultrium 5 tape drives cannot read Ultrium 1 or Ultrium 2 tapes.

Supported cartridges include:

- LTO Ultrium 1500 GB Data Cartridge (Ultrium 5)
- LTO Ultrium 800 GB Data Cartridge (Ultrium 4)
- LTO Ultrium 400 GB Data Cartridge (Ultrium 3)
- Write-Once-Read-Many WORM Data Cartridge (Ultrium 3, Ultrium 4, Ultrium 5)
- LTO Ultrium 200 GB Data Cartridge (Ultrium 2)
- 100 GB Data Cartridge (Ultrium 1; read only)
- LTO Ultrium Cleaning Cartridge

---

## Library Specifications

### Physical Specifications

Table 1-5. Physical Specifications

Specification	2U library	4U library
Height	Rack mount 87.6 mm (3.44 in), stand-alone 97.6 mm (3.84 in)	Rack mount 175.2 mm (6.9 in), stand-alone 185.2 mm (7.3 in)
Width	447.5 mm (17.6 in.)	447.5 mm (17.6 in.)
Depth	Rack mount 740 mm (29.13 in), stand-alone 810 mm (31.9 in)	Rack mount 740 mm (29.13 in), stand-alone 810 mm (31.9 in)
Weight with 1 drive and without media	15.59 kg (34.37 lbs.)	21.32 kg (47 lbs.)
Weight with media	20.67 kg (45.57 lbs.)	31.71 kg (69.9 lbs.)

## Power Specifications

Table 1-6. Power Specifications

AC power voltage	100-127 VAC; 200-240 VAC (4 - 2 A)
Line frequency	50-60 Hz

## Operation Specifications

Table 1-7. Operation Specifications: Ultrium 5

Library with Ultrium 5 drive(s)	2U Library	4U Library
Maximum storage capacity	Maximum number of data cartridges: 24 Native: 36 TB Compressed: 72 TB (2:1 compression)	Maximum number of data cartridges: 48 Native: 72 TB Compressed: 144 TB (2:1 compression)
Number of slots	24 (including I/O Station)	48 (Including 3 I/O station slots)
Sustained native data transfer rate	Ultrium 5 Drive: 140 MB/s Ultrium 5 Drive: 140 MB/s	
Drive types	Ultrium 5 Drive Fibre Channel, SAS Ultrium 5 Drive: Fibre Channel, SAS	
Interfaces	8 Gb/s Fibre Channel 6 Gb/s SAS	
*Host Interface Drive Transfer Rates may vary depending on host usage and interface utilization.		

Table 1-8. Operation Specifications: Ultrium 4

Library with Ultrium 4 drive(s)	2U Library	4U Library
Maximum storage capacity	Maximum number of data cartridges: 24 Native: 19.2 TB Compressed: 38.4 TB (2:1 compression)	Maximum number of data cartridges: 48 Native: 38.4 TB Compressed: 75.2 TB (2:1 compression)
Number of slots	24 (including I/O Station)	48 (Including 3 I/O station slots)
Sustained native data transfer rate	Ultrium 4 Full Height Drive: 120 MB/s Ultrium 4 Half Height Drive: 120 MB/s	
Drive types	Ultrium 4 Full Height Drive Fibre Channel, SAS Ultrium 4 Half Height Drive: SAS, Fibre Channel	
Interfaces	Ultrium 4 HH Fibre Drive V2 (8Gb/s) Ultrium 4 HH SAS Drive V2 (6Gb/s)  4 Gb/s Fibre Channel 3 Gb/s SAS	
*Host Interface Drive Transfer Rates may vary depending on host usage and interface utilization.		

Table 1-9. Operation Specifications: Ultrium 3

Library with Ultrium 3 drive(s)	2U library	4U library
Maximum storage capacity	Maximum number of data cartridges: 24 Native: 9.6 TB Compressed: 19.2 TB (2:1 compression)	Maximum number of data cartridges: 48 Native: 19.2 TB Compressed: 38.4 TB (2:1 compression)
Number of slots	24 (including I/O Station)	48 (Including 3 I/O station slots.)
Sustained native data transfer rate	Ultrium 3 Full Height Drive: 80 MB/s Ultrium 3 Half High V2 Drive: 80 MB/s Ultrium 3 Half Height Drive: 60 MB/s	
Drive types	Ultrium 3 Full Height Drive: SCSI, Fibre Channel Ultrium 3 Half Height Drive: Serial Attached SCSI (SAS)	
Interfaces	Ultra160 SCSI LVD 4 Gb/s Fibre Channel Ultrium 3 HH SAS Drive V2 (6Gb/s) 3 Gb/s SAS	

## Environmental Specifications

Table 1-10. Environmental Specifications

Temperature	
Operating	10° to 35° C (50° to 95° F)
Storage, without cartridges	-30° to 60° C (-22° to 140° F)
Wet bulb, operating	26° C (79.0° F) maximum
Temperature shock immunity - maximum rate of change	10° C (18° F) per hour
Miscellaneous	
Dust concentration	less than 200 microgram/cubic meter
Altitude (operating)	2500 meters (8200 ft.) at 25°C ambient
Maximum acoustical noise sound power levels LwAd in bels	6.6/6.8
Humidity	
Operating	15% to 80% RH non-condensing
Storage, without cartridges	10% to 90% RH non-condensing

## Product Environment

The library is designed to operate in a general business environment.

The library meets the acoustical requirements for general business area category 2D. Category 2D states that the library should be installed a minimum of 4 m (13 ft.) from a permanent work station.

To allow for service access, install the library a minimum of 0.9 m (3 ft.) from all obstacles.

The library is a precision computer peripheral. To ensure maximum longevity of your library, locate the library away from dust, dirt, and airborne particulates:

- Keep the library away from high-traffic areas, especially if the floor is carpeted. Carpeting harbors dust and people walking on the carpet can cause the carpet fibers and the dust to become airborne.
- Keep the library out of printer/copier rooms because of toner and paper dust. Additionally, do not store paper supplies next to the library.
- Keep the library away from moving air caused by doorways, open windows, fans, and air conditioners.

Ensure that the machine covers are always kept closed to minimize any contamination from airborne particles.

---

## Supported Device Drivers

The latest levels of device drivers can be downloaded by visiting <http://support.dell.com>.

**Note:** The TL2000 and TL4000 libraries utilize the generic SCSI drivers in RHEL 4, 5 and 6. Depending on the ISV you are using, you will use either the sg or st driver. Please refer to your ISV documentation for more information on which driver to use.

---

## Chapter 2. User Interfaces

This library has two user interfaces.

- Operator Control Panel - located on the front panel of the library
- “Web User Interface” on page 2-4 - accessed via a web browser

---

### Operator Control Panel

The Operator Control Panel operates in two basic modes.

- **User Interaction mode** - This mode is employed when a user is pushing buttons on the Operator Control Panel.
- **System Driven mode** - This is the normal mode of operation. In this mode, the Operator Control Panel displays status associated with the actions that were caused from commands issued via the drive's internal (drive to library) serial interface.

When an Operator Control Panel button is pressed and released, the Operator Control Panel automatically transitions to User Interaction mode. User Interaction mode will continue until 3 minutes after a user stops pushing buttons, or the requested accessor action stops - whichever is longer. At which time, the Operator Control Panel will return to System Driven mode.

If necessary, the Operator Control Panel automatically transitions to the System Driven mode. When this occurs, the library must remember the previous function before the display mode changed. Therefore the next button pressed only transitions the Operator Control Panel to the User Interaction mode from the System Driven mode.

In case of the activated user security feature, the User Interaction mode is restricted to **Login** and **Monitor** menu items, until a user logs in with a correct password.

### Operator Control Panel Philosophy

Operator Control Panel operation must obey some basic rules. These rules of operation constitute a philosophy.

- Any operational conflict between commands received over the host interface or the Web User Interface and those entered via the Operator Control Panel will be avoided with a reservation mechanism on a first-come, first-served basis. Any reservation by the Operator Control Panel is canceled by an Operator Control Panel logout or a timeout, which cancels the User Interaction Mode.
- Library firmware will not allow a user to select an impossible request. Those situations will include, but are not limited to:
  - Moving a cartridge from any source to a full slot
  - Moving a cartridge from an empty slot
  - Loading a cartridge from any source to a full drive
  - Unloading a cartridge from an empty drive
- Any error detected by the library or drive controller and not recoverable through predetermined firmware algorithms will be considered as fatal. An error code will be displayed on the Operator Control Panel display and the error LED will

become illuminated. The error code remains on the Operator Control Panel until a push button is pressed, which causes the Operator Control Panel to return to the Home Screen.

- Numeric error codes are only used for unrecoverable, fatal errors, otherwise text status messages are displayed.

## Power-ON Display

When the library powers ON or resets, it goes through several internally controlled processes that allow it to get initialized and running. These processes are called Power-On-Self-Test (POST). During the POST the Operator Control Panel displays information that may be meaningless until POST is complete. When the POST is finished, the library displays the Startup screen, then the Home screen.

The Startup screen is the first screen that appears after powering ON the library. It contains the following information:

- Firmware Rev: the current level of library firmware
- Drives: the total number of drives that the library can support
- Magazines: the total number of magazines in the library
- I/O Station: the current status of the I/O Station

While the library is going through its power up cycle you can monitor the state of the library via the OCP; however, you may not be able to make any configuration changes until the unit has completed its initialization routine. Attempts to make changes will be ignored.

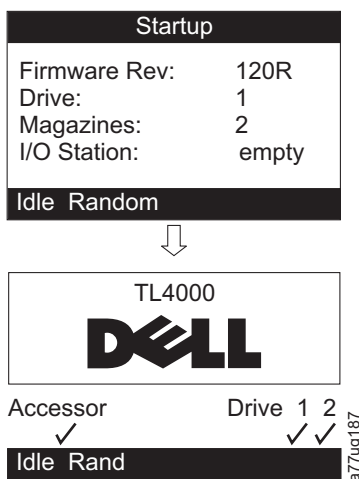

Figure 2-1. Power-ON screens

## Note about the Front Panel LEDs

All LEDs are updated during power ON and reset sequences. Upon power ON or software reset, the library illuminates all LEDs as soon as POST allows. When initialization starts, all LEDs are extinguished and the Ready/Activity LED flashes at a rate of approximately one second per cycle. When the mechanical initialization is complete, the Ready/Activity LED will stop flashing and be constantly illuminated.

If a library failure occurs, the Ready/Activity LED will turn OFF and the Error LED illuminates. The Operator Control Panel will also display an appropriate error code to help identify the failure.

The following are additional operational details of LEDs:

- The **Ready/Activity** LED is illuminated any time the unit is powered ON and functional. The Ready/Activity LED blinks whenever there is library or drive activity. This LED will also blink when the unit is OFFLINE.
- The **Clean** LED is illuminated when either a cleaning requested or a cleaning required flag has been issued by the drive. The LED is turned off after a successful drive cleaning operation.
- The **Attention** LED indicates one of the following conditions.

Problem	Action Required
Bad media	<ol style="list-style-type: none"> <li>1. Go to <b>Monitor</b> → <b>Inventory</b> to locate the defective cartridge.</li> <li>2. Move the defective cartridge to the I/O Station. (Operator Control Panel: <b>Control</b> → <b>Move Cartridges</b>).</li> <li>3. Open the I/O Station to remove the defective cartridge. (Operator Control Panel: <b>Control</b> → <b>Open I/O</b>).</li> </ol>
Drive sled issues	Do one of the following: <ul style="list-style-type: none"> <li>- Install a drive sled (see “Removing/Installing/Adding a Tape Drive Sled” on page 10-3).</li> <li>- Modify or resubmit Logical Library setting (Operator Control Panel: <b>Configure</b> → <b>Logical Libraries</b> or Web User Interface: <b>Configure Library</b> → <b>Logical Libraries</b>).</li> <li>- Restore defaults (Operator Control Panel: <b>Configure</b> → <b>Restore Defaults</b> or Web User Interface: <b>Configure Library</b> → <b>Restore Defaults</b>).</li> </ul>
Redundant power supply failed	Complete the following steps: <ol style="list-style-type: none"> <li>1. Replace the failed power supply (see “Replacing a Power Supply” on page 10-10).</li> <li>2. Cycle library power.</li> </ol>
Power supply fan failure	Replace the power supply.

- The **Error** LED is illuminated when there is an unrecoverable (i.e. hard) drive or library failure. This will happen at the same time the hard error message is displayed on the screen and the LED will remain lit until the error state is resolved.

**Note:** From the Operator Control Panel, run **Service** → **Library Verify**. If Library Verify runs without error, the Error LED turns off. If the error persists, recycle power.

## Input Modes

There are several ways to enter values in the different menu items. These values are selectable predefined values, toggle values (for example, ON/OFF) and numerical values like network addresses.

### Selecting Predefined Values

1. To set the predefined values, press the SELECT button to select the menu item.
2. Using the UP and DOWN buttons, select one of the various predefined values for that item.

3. As soon as the Operator Control Panel display shows the correct value, press the SELECT button to apply the value.

### **Toggling Values**

Toggle values are used to switch between two different states like *ON* and *OFF*.

1. After navigating to the menu item, press the SELECT button to select the menu item.
2. Using the UP and DOWN buttons, select one of the various predefined states for that item.
3. Press the SELECT button to apply the new state.

### **Entering Numerical Values**

Numerical values are needed for network addresses, password entries and other configuration entries.

1. After navigating to the menu item, the current value is displayed and the cursor highlights the first digit of the value that can be changed.
2. For each digit to be changed in the value:
  - a. Use the UP and DOWN buttons to increment / decrement the digit.
  - b. Press the SELECT button to highlight the next editable digit.
3. Press the SELECT button at the last digit to apply the complete entry, or press the CANCEL button to cancel the whole edit process and maintain the original value.

### **Power ON/OFF**

Part of the Operator Control Panel is the Power ON/OFF button. If the library is powered ON, pressing this button for 4 seconds will initiate a controlled power down of the library (soft landing). The following operations will take place before the library shuts down completely:

- The display indicates with an appropriate message that the shutdown is in progress.
- The library controller finishes all ongoing library and drive activities.
- The accessor is moved to its home position.
- The library controller switches OFF the power supply's secondary side.

**Note:** The shutdown process may be aborted by releasing the button before 4 seconds has passed.

---

## **Web User Interface**

Many of the same operations performed from the Operator Control Panel can also be performed remotely using the Web User Interface.

The Web User Interface lets you monitor and control your library from any terminal connected to your network or through the World Wide Web (WWW). The Web User Interface hosts a dedicated, protected Internet site that displays a graphical representation of your library.

For static IP Addresses only: After establishing a connection to the library, open any HTML browser and enter the IP address of the library. To configure the Web



User Interface, you must first set the IP address using the Operator Control Panel. Refer to "Configure: Network" on page 5-23 or "Configure Library: Network" on page 5-45.

## Login

**Important:** Some options of the Web User Interface take the library OFFLINE. This inactive mode can interfere with host-based application software, causing data loss. Make sure the library is idle before attempting to perform any remote operations that will take the library OFFLINE.

To login, select the Role type and enter the correct password. The TL4000/TL2000 RMU screen shows Welcome : User, superuser, admin, or service after a successful login. The user can log out at any time by clicking on the "logout" text located in to top right corner of the RMU page.

- The User only has access to Monitor Library menus. The User account has only viewing privileges to the unit, not able to make any configuration changes.
- Superuser - The Superuser has access to the Monitor Library and Manage Library sections.
- The Admin user has access to all menus except those restricted to Service only. The Admin account has access to monitor, configure and run unit diagnostics (only exception is the advanced diagnostics reserved for service personnel only).
- Service personnel have access to all menus. The Service account has all the same privileges as the Admin account with the addition of advanced unit diagnostics.

**Note:** User and Superuser accounts must be enabled by the library administrator. These accounts are disabled by default.

**Note:** Passwords are case-sensitive.

Use the following password for logging in as an Admin user: **secure**

Each level affects which areas you have access to and what actions you can initiate from those areas.

For DHCP, use the Operator Control Panel to determine the IP Address assigned to your library. Navigate to **Monitor** → **Library** → **Identity**. Scroll down to **IP Address** and make note of the address. Enter the IP Address in your internet browser address field to access your library with the Web User Interface.

For IPv4 or Dual Stack IPv4 + IPv6, enter your library's static IP Address using the 0.0.0.0 format (four octets).

For IPv6, enter your library's static IP Address or Router Assigned IP Address using the following format: http://[0:0:0:0:0:0:0:0]. To determine your Router Assigned IP Address, navigate to **Monitor** → **Library** → **Network** on the Operator Control Panel.

If the dual IP stack is enabled (IPv4 + IPv6), IPv6 addresses cannot be configured in the OCP (Operator Control Panel) and must be configured through the Web User Interface. IPv6 addresses can only be configured in the OCP if the IPv6-only stack is enabled. In the case where the dual stack is enabled, the IPv6 address must be configured through the web interface (either using the IPv4 address or a known

other IPv6 address).



Admin

Log in

a77ug070

Figure 2-2. Web User Interface login page

## System Status

The **System Status** screen is always present after login giving current status of the library.



System Status	
<a href="#">View Legend</a>	
03/28/2007 15:59:24	
<b>Library Name</b>	BOSTON141
<b>Status</b>	Ready
<b>Drive 1 Status</b>	Ready
<b>Slots (Empty/Total)</b>	22/23
<b>I/O Station</b>	Disabled
<b>Library Time</b>	15:59:24

a77ug080

Figure 2-3. 2U library System Status screen



System Status	
<a href="#">View Legend</a>	
03/28/2007 15:27:45	
<b>Library Name</b>	ATLANTA162
<b>Status</b>	Ready
<b>Drive 1 Status</b>	Ready
<b>Drive 2 Status</b>	Ready
<b>Slots (Empty/Total)</b>	42/44
<b>I/O Station</b>	Closed
<b>Library Time</b>	15:27:45
<b>Auto Clean Status</b>	Chk Media/Rsvd Slot?
<b>Power Supply Status</b>	2 Online

a77ug089

Figure 2-4. 4U library System Status screen

Status icons indicate the following conditions.

- The green check mark indicates that the library is fully operational and that no user intervention is required.
- The yellow exclamation point indicates that user intervention is necessary, but that the library is still capable of performing operations. This condition can be caused by a media, library, redundant power supply, power supply fan, or a drive sled problem. To determine which, view the System Status screen.
- The red X indicates that user intervention is required and that the library is not capable of performing operations.

- If Auto Clean is enabled and a cleaning cartridge is **not** present, or if a cleaning cartridge is present, but not in a reserved slot, Auto Clean status will show **Chk Media/Rsvd Slot?** and **Status** will show a green check mark and the words **Media Attention**. The Auto Clean status disappears from the system status screen once Auto Clean has been properly configured. You will get messages if the cleaning media expires.

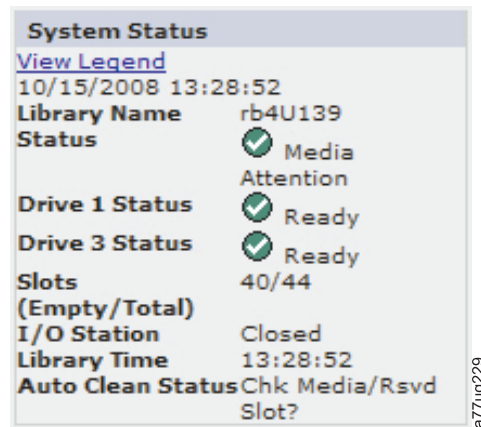

Figure 2-5. 4U library System Status screen showing media attention status

- The Power Supply Status will only appear if redundant power is being utilized with a 4U library, and the library was manufactured after March 14, 2008. If a redundant power supply fails, the System Status screen will appear as shown in Figure 2-6.

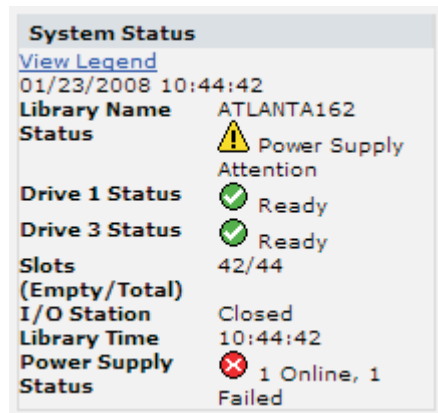

Figure 2-6. 4U library System Status screen showing a power supply failure

**Note:** If your library has -04 level redundant power supplies (see label on top of power supply), it is normal for the one in “Standby” mode to turn its “Green” LED off. You can test this power supply by pulling the power connector from the other “Active” power supply. The power supply that was in “Standby” mode will now become “Active”, and its “Green” LED should light. If it doesn’t, replace it (refer to “Replacing a Power Supply” on page 10-10).

If your library has -05 level redundant power supplies, the "Green" LED will be ON on both power supplies. If both "Green" LEDs are not ON, replace the failed power supply (refer to "Replacing a Power Supply" on page 10-10).

## Web User Interface Help Pages

Each screen on the Web User Interface has an associated Help page. To access a Help page, click on **Help** in the upper right corner of the screen. A new web page will open. Using the left navigation pane, select the desired Help page. To close the Help page, click the red **X** in the upper right corner of the screen.

## Logging out of the Web User Interface

To log out of the Web User Interface, click **Logout** in the upper right corner of the current screen.

**Important:** If you click the **X** in the upper right corner of your internet browser window, you will not log out of the Web User Interface.

---

## Chapter 3. Installation Planning

Before installing your library, take time to review the following information.

---

### Determining the Number of Logical Libraries

You can partition the library into as many logical libraries as there are drives in the library.

#### Basic Guidelines

- Each logical library must contain at least one drive.
- A library configuration of exactly one logical library equals the entire physical library.
- The library issues a warning to the user if media is moved across logical libraries.

#### Library Sharing

The library's default configuration allows a single application to operate the library through a single control path. Often, it is advantageous to be able to share a single library between heterogeneous (dissimilar) or homogeneous (similar) applications. Some applications (and some servers) do not allow for sharing a library between systems. Configurations can be created that enable the library to process commands from multiple heterogeneous applications and multiple homogeneous applications.

From the library's Web User Interface or Operator Control Panel, the following actions can be performed:

- Configure the library so that it is partitioned into separate logical libraries that independently communicate with separate applications through separate control paths. This configuration requires no special capabilities from the server or application. (For more information, see "Using Multiple Logical Libraries for Library Sharing" on page 3-2.)
- Configure any single logical library (including the entire physical library) so that it is shared by two or more servers that are running the same application. Depending on the capabilities of the server and application, there are several ways to set up this type of configuration. Three typical ways include:
  - Configuring one server (host) to communicate with the library through a single control path; all other servers send requests to that server through a network.
  - Configuring all of the servers to communicate with the library through a single, common control path. This configuration is used in high-availability environments. Multi-initiator configurations are only supported by certain adapters and independent software vendors (ISVs). Check with your ISV.
  - Configuring a single logical library to communicate with multiple servers through multiple control paths. This configuration requires that control paths be added (see "Using Multiple Control Paths" on page 3-2).

Library configuration is not limited to the examples given above. Many configurations are possible, and can be designed according to your business needs. For additional information, refer to your host application documentation.

## Using Multiple Logical Libraries for Library Sharing

Multiple logical libraries are an effective way for the library to simultaneously back up and restore data from heterogeneous applications. For example, the library can be partitioned so that it processes:

- Commands from Application A (about Department X) in Logical Library 1
- Commands from Application B (about Department Y) in Logical Library 2

In this configuration, the storage slots and drives in each logical library are dedicated to that library and are not shared among other libraries. Commands issued by the applications travel to the library through two unique control paths. Thus, the data processing for:

- Department X is confined to the storage slots and drives in Logical Library 1
- Department Y is confined to the storage slots and drives in Logical Library 2

---

## Using Multiple Control Paths

In addition to creating multiple logical libraries, any logical library can be configured to have more than one control path. When configuring additional control paths, additional library sharing configurations and availability options are made possible. Access to the logical library is on a first-come, first-served basis and each control path for a logical library can accept commands while the library is in use by another control path. By default, only the first drive in a logical library will be LUN-1 enabled.

For a particular logical library, you can enable as many control paths as there are drives in that logical library.

## Using Multiple Control Paths for Path Failover

Command failures and timeouts are costly. You want your library to run smoothly and efficiently. To ensure continued processing, the library offers an optional path failover feature that enables the host device driver to resend the command to an alternate control path for the same logical library. With control path failover installed, the alternate control path can include another HBA, SAN, or library control path drive. The device driver initiates error recovery and continues the operation on the alternate control path without interrupting the application.

Path Failover is a combination of two previous features: Control Path Failover (key entered at the library user interface) and Data Path Failover (key entered at the device driver interface). For library firmware of 8.xx or lower the Path Failover feature is available for LTO 4 tape drives. Library firmware levels higher than 8.xx support Path Failover on LTO 5 drives, as well as LTO 4 Full Height drives.

The Path Failover feature can be installed by the customer.

For more information about using the path failover feature, see the *Dell PowerVault TL4000 Failover Configuration Guide*, included with the library documentation if purchased at point of sale and with the customer kit if purchased later.

---

## Library Partitioning and Element Addressing

Library 4U systems with firmware versions of .80 and higher, and containing at least 2 drives, have the ability to configure two logical libraries (create two partitions). This partitioning has been expanded with the new library firmware and half-high drive integration. Now it is possible to configure 1, 2, 3 or 4 partitions in

the 4U library. Additionally the 2U library can now be configured into one or two partitions. Each library must contain at least one drive per logical library (partition). In a partitioned library, the Operator Control Panel (OCP) only reports the status of logical library 1 in the main menu due to space limitations. The user must navigate to the logical libraries status in the OCP to get the information on the additional library partitions.

## Partitioning of 2U Libraries

When two half height drives are installed in a 2U library, the library firmware will support partitioning in the same way that the 4U supports partitioning with two full height drives today. The first partition will contain the first magazine and the first drive. The second partition will contain the second magazine and the second drive. The I/O station (if configured as I/O) will be shared, as is done with the partitioned 4U library.

One full height drive is "Drive 1". When using half height drives, the first half height drive position will be called "Drive 1", The second half height drive position will be called "Drive 2."

## Partitioning of 4U Libraries

When one or more half height drives are added to a 4U library, the drive naming will change. Currently, the first full height drive is "Drive 1" and the second full height drive is "Drive 2". When you consider that each full height drive slot may contain one or two half height drives, there are four potential drives in the space that used to occupy two. As a result, the first half height drive position, or the first full-high drive position, will be called "Drive 1". The second half height drive position will be called "Drive 2". The third half height drive position, or the second full height drive position, will be called "Drive 3". The fourth half height drive position will be called "Drive 4".

**Important:** In a 4U library a full height drive sled may be installed in drive slot 1 (drive will occupy slot 1 and slot 2) or drive slot 3 (drive will occupy slot 3 and slot 4). A full height drive sled should never be installed in drive slot 2 (drive will occupy slot 2 and slot 3).

## Mixing of Drives

The library supports a mix of full height and half height drives in the same physical library and the same logical library. They support a mix of Gen 3, Gen 4, and Gen 5 drives in the same physical library and the same logical library. They will also support a mix of SCSI, SAS, and Fibre Channel in the same physical library and the same logical library; however, mixing drive interface types in the same logical library is not recommended.

## Configuration of a 1 - Partition System

A one partition system configured for a 4U library contains any and all drives present in any drive positions, and it will contain all four magazines.

When configured with one logical partition, the Element Address assignments will be as follows: DTE assignments will be as shown in Figure 3-1 on page 3-4.

STE assignments:

- Logical Library 1: Slot1 through 23 4096 (0x1000) through 4118 (0x1016) as shown in Figure 3-4 on page 3-5

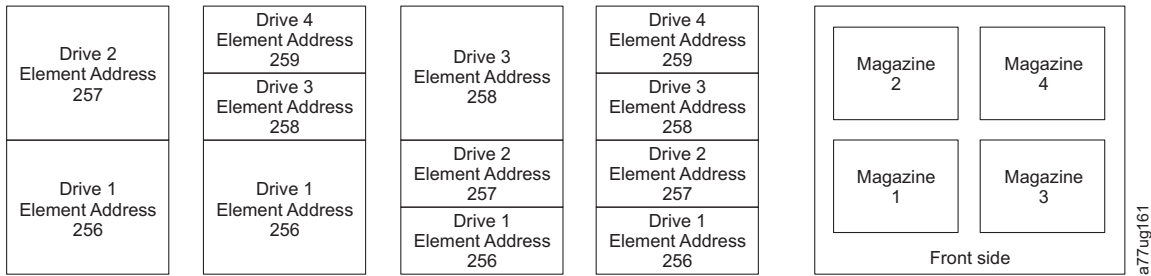

Figure 3-1. Configuration of a one - partition system

### Configuration of a 2 - Partition System

A two partition system must have at least two drives installed. One drive must be installed in either drive position 1 or drive position 2, and another drive must be installed in either drive position 3 or drive position 4. Partition 1 contains any drives in drive position 1 and drive position 2. Partition 1 will also contain magazine 1 and magazine 2. Partition 2 contains any drives in drive position 3 and drive position 4. Partition 2 will also contain magazine 3 and magazine 4.

When configured with two logical partitions, the Element Address assignments will be as follows: DTE assignments will be as shown in Figure 3-2.

STE assignments

- Logical Library 1: Slot 1 through slot 21 4096 (x1000) through 4116 (0x1014)
- Logical Library 2: Slot 22 through slot 45 4096 (x1000) through 4019 (0x1017)

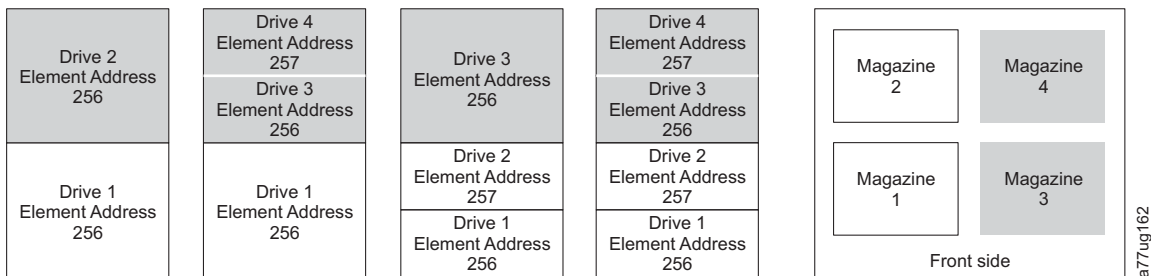

Figure 3-2. Configuration of a two - partition system

### Configuration of a 3 - Partition System

A three partition system must have at least three drives installed. A drive must be installed in drive position 1, another drive must be installed in drive position 2, and another drive must be installed in either drive position 3 or drive position 4. Partition 1 will contain the first drive and the first magazine. Partition 2 will contain the second drive and the second magazine. Partition 3 will contain any drives in drive position 3 and drive position 4. Partition 3 will also contain magazine 3 and magazine 4.

STE assignments

- Logical Library 1: Slot 1 through slot 9 4096 (x1000) through 4104 (0x1008)



- Logical Library 2: Slot 10 through slot 21 4096 (x1000) through 4107 (0x100B)
- Logical Library 3: Slot 22 through slot 45 4096 (x1000) through 4119 (0x1017)

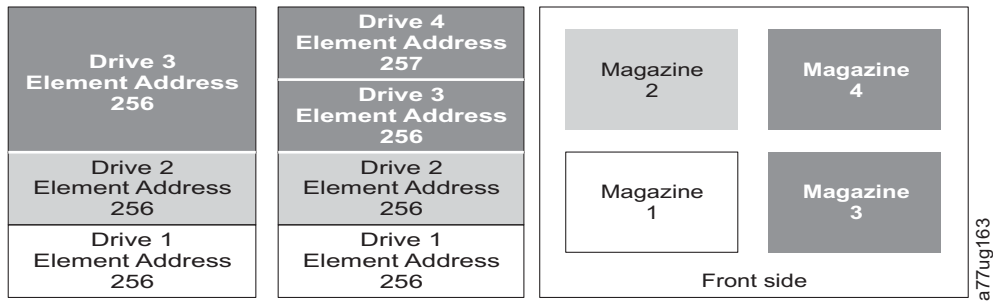

Figure 3-3. Configuration of a three - partition system

### Configuration of a 4 - Partition System

A four partition system must have four drives. Each partition contains one drive and one magazine.

When configured with four logical partitions, the Element Address assignments will be as follows: DTE assignments will be as shown in Figure 3-4.

STE assignments

- Logical Library 1: Slot 1 through slot 9 4096 (x1000) through 4104 (0x1008)
- Logical Library 2: Slot 10 through slot 21 4096 (x1000) through 4107 (0x100B)
- Logical Library 3: Slot 22 through slot 33 4096 (x1000) through 4107 (0x100B)
- Logical Library 4: Slot 34 through slot 45 4096 (x1000) through 4107 (0x100B)

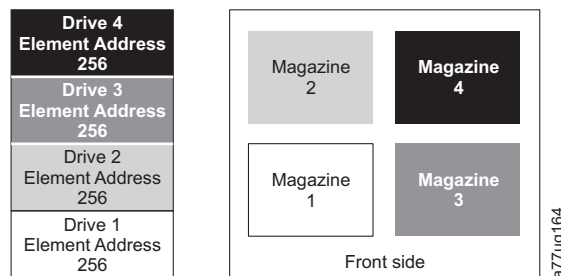

Figure 3-4. Configuration of a four - partition system

### SCSI Element Addressing

Every logical library starts at the first drive slot with the current assigned element start address (default value 256). It will be incremented from the bottom to the top slots for every drive slot. There is one exception to this addressing scheme to accommodate libraries currently in the field. A 4U library containing only full height drives will continue to have the addresses assignments 256 and 257, thus causing no interruptions to their operation. Drive slots will still be incremented by 1 for each drive slot position.

**Note:** Exchanging drives with different form factors will result in the library needing to be reconfigured.

4U Unit with only FH drives  
(1 logical library)

SCSI Element	Slot
257	4
	3
256	2
	1

4U Unit with FH and HH drives  
(1 logical library)

SCSI Element	Slot
258	4
	3
257	2
256	1

a77ug165

Figure 3-5. Examples of SCSI element addressing

The SCSI specification does not allow gaps in the SCSI element addressing. Special handling is needed for empty drive slots to fulfill the specification. Also temporarily removed drives need to have their addresses preserved to not confuse the attached host and host application. Generally only drives which are currently physically available or temporarily removed are reported. Empty (unused) slots located at the bottom or the top should not be reported, with an exception in case of a “removed” condition. A drive slot which does not contain a drive, and has a position between used slots, needs to be reported as a SCSI element. To signal the host application that this slot is not usable, its ACCESS bit will be disabled.

**Note:** When reducing the number of drives in your library, update the Logical Library configuration. This will remove the Attention LED on the front panel and the exclamation mark on the Home screen indicating that a drive is missing.

Updating the Logical Library configuration will also update the drive element addressing and drive numbering. Replacing LTO half height drives with full height drives may require you to execute Restore Factory Defaults to correctly update the drive element addressing and drive numbering. See “Configure Library: Save/Restore Configuration” on page 5-56.

---

## Logical Unit Number (LUN) Scanning

The library uses a single SCSI or Loop ID per drive and dual LUNs to control the tape drive (LUN 0) and library accessor (LUN 1). The library requires a Host Bus Adapter (HBA) that supports LUN scanning. If it is not enabled, your host system will not scan beyond LUN 0 and will fail to discover the library. It will only see the tape drive.

**Important:** Some HBAs, such as RAID controllers, do not support LUN scanning.

---

## Host Interfaces

The 2U library and the 4U library can be attached to servers using the following interfaces:

- SCSI (LVD Ultrium 160)
- Serial Attached SCSI (SAS)
- Fibre Channel

*Table 3-1. Host Drive Interface Support*

Drive	SCSI (LVD Ultra 160)	SAS	FC
Ultrium 3 FH	X		X
Ultrium 3 HH		X	
Ultrium 4 FH		X*	X
Ultrium 4 HH		X	
<b>Note:</b> * = Dual Port SAS			

## SCSI Interface

**Note:** Although the LVD hardware in the library is capable of operating in single-ended (SE) mode, SE operation is not recommended.

The library supports SCSI LVD attachments by using SCSI cables with 68-pin, HD-connectors. SCSI adapters must be properly terminated.

Before installing the SCSI cables, inspect all cables for damage. Do not install a cable if it is damaged. Report the damage immediately by contacting Dell customer care.

The maximum allowable length of your bus cabling depends on the type of SCSI bus that you use (LVD).

- For a server with an LVD SCSI bus:
  - Use a maximum system-to-device cable length of 10 m (33 ft) when attaching to the host interface board (SCSI) and one or two daisy-chained drives.
  - Use a maximum system-to-device cable length of 5 m (17 ft) when attaching to the host interface board (SCSI) and three to six daisy-chained drives.

**Note:** For maximum performance, it is recommended to have a maximum of one drive per SCSI bus.

- Only use the maximum system-to-device cable length of 25 m (82 ft) when attaching directly to one device (a point to point interconnection).

**Note:** Daisy-chaining is NOT recommended due to potential issues with SCSI bus performance, SCSI cables/connectors, and host bus adapters.

### Physical Characteristics of the SCSI Interface

The library operates as a set of SCSI-3 devices. The Ultrium Tape Drives attach to servers using an LVD Ultra160 SCSI interface. Each SCSI drive sled uses shielded, HD68-pin connectors, and can attach directly to a 2-byte-wide SCSI cable.

Any combination of up to two initiators (servers) and up to four targets (devices) is allowed on a single SCSI bus if the following conditions are met:

- The SCSI bus is terminated properly at each end
- Cable restrictions are followed according to the SCSI-3 specification

Under the SCSI-3 protocol, this type of attachment allows cable lengths of up to 25 m (81 ft) with the appropriate cable and terminator. The table below gives the maximum bus length between terminators for the LVD interface.

*Table 3-2. Maximum bus length between terminators*

Type of Interconnection	Maximum Bus Length Between Terminators (in meters)
Point-to-point (1 server and 1 drive)	25
Multi-drop/daisy-chain (1 server and multiple drives)	12 (LVD)
<b>Note:</b> The maximum bus lengths stated in this table include the internal length of the bus.	

For maximum performance, multiple SCSI buses may be required (see “Using Multiple SCSI Buses”), and Ultrium Tape Drives must be the only target devices that are active on the bus.

**Note:** Daisy-chaining is NOT recommended due to potential issues with SCSI bus performance, SCSI cables/connectors, and host bus adapters.

**Note:** For maximum performance, the quantity of tape drives that you can attach to one SCSI bus is limited, and is based on the type of bus that you have and the amount of data compression achieved. Ultra160 SCSI buses have a bandwidth of 160 MB per second. The table below lists the types of SCSI buses and gives the recommended maximum quantity of drives that you can attach.

*Table 3-3. Recommended maximum quantity of drives per SCSI bus*

Type of Drive	Ultra 160 SCSI Bus
LVD Ultrium 3	1 drive at 2:1 compression

## Using Multiple SCSI Buses

The library has two SCSI connectors for each tape drive in the library. Each drive can be daisy-chained using a SCSI bus jumper.

**Note:** Daisy-chaining is NOT recommended due to potential issues with SCSI bus performance, SCSI cables/connectors, and host bus adapters.

Removal of any jumpers will create a SCSI bus for each drive installed in your library for attachment to multiple servers or to multiple SCSI adapter cards on one server. Remember that each SCSI bus must be terminated. Multiple SCSI buses may be required for maximum performance, depending on the application and data compression ratio. Note, however, that library (Medium Changer) control is required on at least one SCSI bus.

The Medium Changer device is required to be addressed via LUN 1 of the lowest-numbered drive position of each logical library. The Medium Changer device may additionally be addressed via LUN 1 of other drives in any logical library.

Any bus containing a Medium Changer device via LUN 1 of a drive is referred to as a control and data path. Any other bus is referred to as a data path. For information about control paths, see “Using Multiple Control Paths” on page 3-2.

### **Terminating the Bus**

The SCSI bus and all of the wires in the SCSI cable must be properly terminated according to the SCSI standard.

You can plug an external terminator into one of the SCSI connectors. A terminator must be installed on the last device on each end of a string of multiple devices. A terminator is included with each SCSI Ultrium Tape Drive.

### **SCSI Differential - LVD**

LVD tape devices support a bus length of 25 meters (82 ft.) point-to-point, and 12 meters (39 ft.) using multi-drop interconnection (daisy-chaining). For each daisy-chained device, the maximum cable length must be reduced by 0.5 meters (1.6 ft.).

**Important:** A faster bus does not imply that an attached device will support that data rate, but that multiple devices can operate on the bus at that maximum speed. For a detailed table of SCSI terms and related specifications, refer to the SCSI Trade Association Web site at <http://www.scsita.org/terms/scsiterms.html>. To ensure best performance, if possible, avoid daisy-chaining.

## **SAS Interface**

A drive sled with a SAS (Serial Attached SCSI) interface can be linked directly to controllers. SAS is a performance improvement over traditional SCSI because SAS enables multiple devices (up to 128) of different sizes and types to be connected simultaneously with thinner and longer cables; its full-duplex signal transmission supports up to 6.0 Gb/s. The SFF-8088 SAS connectors on the Ultrium 5 tape drives are compatible with SAS-1 or SAS-2 cables. The SFF-8088 SAS connectors on the Ultrium 3 and Ultrium 4 tape drives are compatible with SAS-1 cables. In addition, SAS drives can be hot-plugged.

SAS drives will auto-negotiate speed. There are no configurable topologies thus no feature switches associated with SAS. The SAS Ultrium 3 and Ultrium 4 half height drive sleds are single ported and can only be attached to one host. The Ultrium 4 full height and Ultrium 5 drives are dual ported, and can be attached to a maximum of two hosts. The intention of the second port is for redundancy; for failover rather than sharing. Sharing between these two hosts is limited to active/passive cluster failover. LAN-free drive sharing is not supported. Ultrium 3 and Ultrium 4 SAS drive sleds use the SFF-8088 connection at the drive sled end and SFF-8088 or SFF-8470 at the host adapter end.

## **Fibre Channel Interface**

Fibre Channel allows for an active intelligent interconnection scheme, called a Fabric, to connect devices. Everything between the ports on Fibre Channel is called the Fabric. The Fabric is most often a switch or series of switches that takes the responsibility for routing.

The library allows the selection of the following Fibre channel port behaviors:

- LN Port: (default setting) - an automatic configuration that tries arbitrated loop first, then switched fabric
- L Port - arbitrated loop

- N Port - point to point protocol in a switched fabric topology

## Cables and Speeds

Ultrium 3, Ultrium 4, and Ultrium 5 Fibre Channel tape drives use LC duplex fiber optics cables.

The maximum distances that the library supports on a Fibre Channel link is determined by the link speed, the type of fiber (50-micron or 62.5-micron), and the device to which the library is attached.

If the library attaches to an HBA (Host Bus Adapter), refer to the distances that are supported by the HBA. If the library attaches to a switch, the supported distances are:

- For a multi-mode 50-micron cable:
  - 1-Gbit link speed = up to 500 m (1640 ft)
  - 2-Gbit link speed = up to 300 m (984 ft)
  - 4-Gbit link speed = up to 175 m (574 ft)
  - 8-Gbit link speed = up to 150 m (492 ft)
- For a multi-mode 62.5-micron cable:
  - 1-Gbit link speed = up to 300 m (984 ft)
  - 2-Gbit link speed = up to 90 m (295 ft)
  - 4-Gbit link speed = up to 50 m (164 ft)
  - 8-Gbit link speed = up to 21 m (68 ft)

**Note:** Minimum distance for both 50 micron and 62.5 micron is 2 m (6 ft).

The library uses 50-micron cables internally. Therefore, you must use a 50-micron cable to attach to the library's port. To attach to a 62.5-micron SAN, you must attach the 50-micron cable to an active port, such as a port on a switch.

## Using Zoning to Isolate Devices and Enhance Security

For security reasons, it is important to limit the devices that a server or servers can recognize or access. Also, some performance configurations and SAN configurations can result in a device being seen multiple times from the same server. For example, if you have two HBAs from the same server connected to an Ultrium Tape Drive in the library, the drive will be detected and appear as two logical devices. That is, there will be two special files for one physical device. Zoning can address these issues.

Zoning allows you to partition your SAN into logical groupings of devices so that each group is isolated from the other and can only access the devices in its own group. Two types of zoning exist: hardware zoning and software zoning. Hardware zoning is based on physical fabric port number. Software zoning is defined with a World Wide Node Name (WWNN) or World Wide Port Name (WWPN). While zoning can be reconfigured without causing an outage, some zoning configurations can become complicated. The advantage of the library's WWNN implementation is that you can avoid the exposure of introducing zoning errors because you do not have to change the zoning configuration if a drive needs service or replacement.

## Sharing on a Storage Area Network

With Storage Area Network (SAN) components, the possibilities for connecting multiple systems and multiple drives have increased. Not all software and systems are designed to share drives. Before you install a drive that would allow two systems to share it, check that the systems and their software support sharing. If

your software does not support sharing, note that Fibre Channel switches have a zoning capability to form a SAN partition. For systems that do not cooperate, use zoning to prevent the systems from sharing the same drive. You can remove zoned partitions as you upgrade software and system levels.





---

## Chapter 4. Installation and Configuration

**Note:** Review the information in "Installation Planning" before installing your library.

To install a desktop or rack mounted 2U library or 4U library, perform the procedures in this chapter in the order they are presented.

---

### Using the Library Configuration Form

Before beginning the installation and configuration of your library, make a copy of the Appendix G, "Library Configuration Form," on page G-1. Enter library information (such as serial numbers, types of drives, etc.) and configuration settings on the Library Configuration Form and store in a safe location for future reference. Be sure to update this form any time changes are made to your library hardware or configuration.

---

### Installing Your Library

Complete these procedures to install your library hardware.

1. "Choosing a Location."
2. "Unpacking the Library" on page 4-2.
3. "Verifying the Shipment" on page 4-2.
4. "Installing the Library Foot Pads (for Desktop Installation ONLY)" on page 4-3.
5. "Removing and Storing the Shipping Lock" on page 4-4.
6. "Rackmounting the Library (for Rack Installation ONLY)" on page 4-6.
7. .
8. "Connecting the Host Interface Cable" on page 4-11.
9. "Connecting a Power Cord" on page 4-13.

### Choosing a Location

Choose a location that meets the following criteria:

*Table 4-1. Location criteria*

Criteria	Definition
Room temperature	10° - 35° C (50° - 95° F ) <b>Note:</b> If the temperature in the room where the library will be installed varies by 15° C (30° F) from the room where the library was stored, allow the library to acclimate to the surrounding environment for at least 12 hours before unpacking it from the shipping container.
Power source	<ul style="list-style-type: none"><li>• AC power voltage: 100-127 VAC; 200-240 VAC (4 - 2 A)</li><li>• <b>Note:</b> The 4U library requires two separate power sources to implement redundant power.</li><li>• Line frequency: 50-60 Hz</li></ul> <p>Place the library near an AC outlet. The AC power cord is the product's main AC disconnect device and must be easily accessible at all times. Two separate power sources must be available for redundant power.</p>

Table 4-1. Location criteria (continued)

Criteria	Definition
Air quality	The library should be placed in an area with minimal sources of particulate contamination. Avoid areas near frequently used doors and walkways, stacks of supplies that collect dust, printers, and smoke-filled rooms. Excessive dust and debris can damage tapes and tape drives.
Humidity	15-80 % RH non-condensing
Clearance	<ul style="list-style-type: none"> <li>• Back: Minimum of 15.4 cm (6 inches)</li> <li>• Front: Minimum of 30.8 cm (12 inches)</li> <li>• Sides: Minimum of 5.08 cm (2 inches)</li> </ul>
Rack requirements	<p>Standard 19-inch rack with:</p> <ul style="list-style-type: none"> <li>• 2U (88.90 mm/3.5 in.) of clearance for a 2U library</li> <li>• 4U (177.8 mm/7 in.) of clearance for a 4U library</li> </ul> <p>Rackmounting the library is optional.</p>

## Unpacking the Library

**Note:** If the temperature in the room where the library will be installed varies by 15° C (30° F) from the room where the library was stored, allow the library to acclimate to the surrounding environment for at least 12 hours before unpacking it from the shipping container.

1. Before you begin, clear a work surface to unpack the library.
2. Before opening and removing the library from the shipping container, inspect the container for shipping damage. If you notice any damage, report it to the shipping company immediately.
3. Open the shipping container and carefully remove the shipping materials from the top of the library. Remove the accessory package and set it aside.

**Important:** Once the drive is unpacked, **save and store** the packaging materials for future moves or shipping.

4. Lift the library out of the carton and remove the bag from the library. Remove the foam cushion from the back of the library. Save the packaging materials for future use.

**Important:** Do not place the library on the front panel or the rear panel as this may damage the library.

## Verifying the Shipment

Verify that the following items are included in your library shipment:

- With every library:
  - Power cord
  - Bar code labels
  - Foot pads (for desktop installation)
- With every library containing a SCSI drive:
  - SCSI terminator (one per SCSI drive)
  - SCSI library-to-host cable (if ordered by customer)
- With every library containing a Fibre Channel drive:
  - Fibre Channel library-to-host/switch cable (if ordered by customer)

- With every library containing a SAS drive:
  - SAS library-to-host cable (if ordered by customer)
- Rack Mount Kit

## Installing the Library Foot Pads (for Desktop Installation ONLY)

If you intend to install your library in a rack, skip this step and proceed to “Removing and Storing the Shipping Lock” on page 4-4.

**Important:** Operating your library on a flat surface without foot pads may damage your library or cause it not to function properly.

Six foot pads must be installed on the bottom of the library before the library can be used as a desktop unit.

To install the library foot pads:

1. Being very careful, lay the library on its side.
2. Peel the adhesive from the back of each foot pad.
3. Install the foot pads on the bottom of the library enclosure by pressing each foot into one of the six areas ( **1** ) as shown in the figure below.

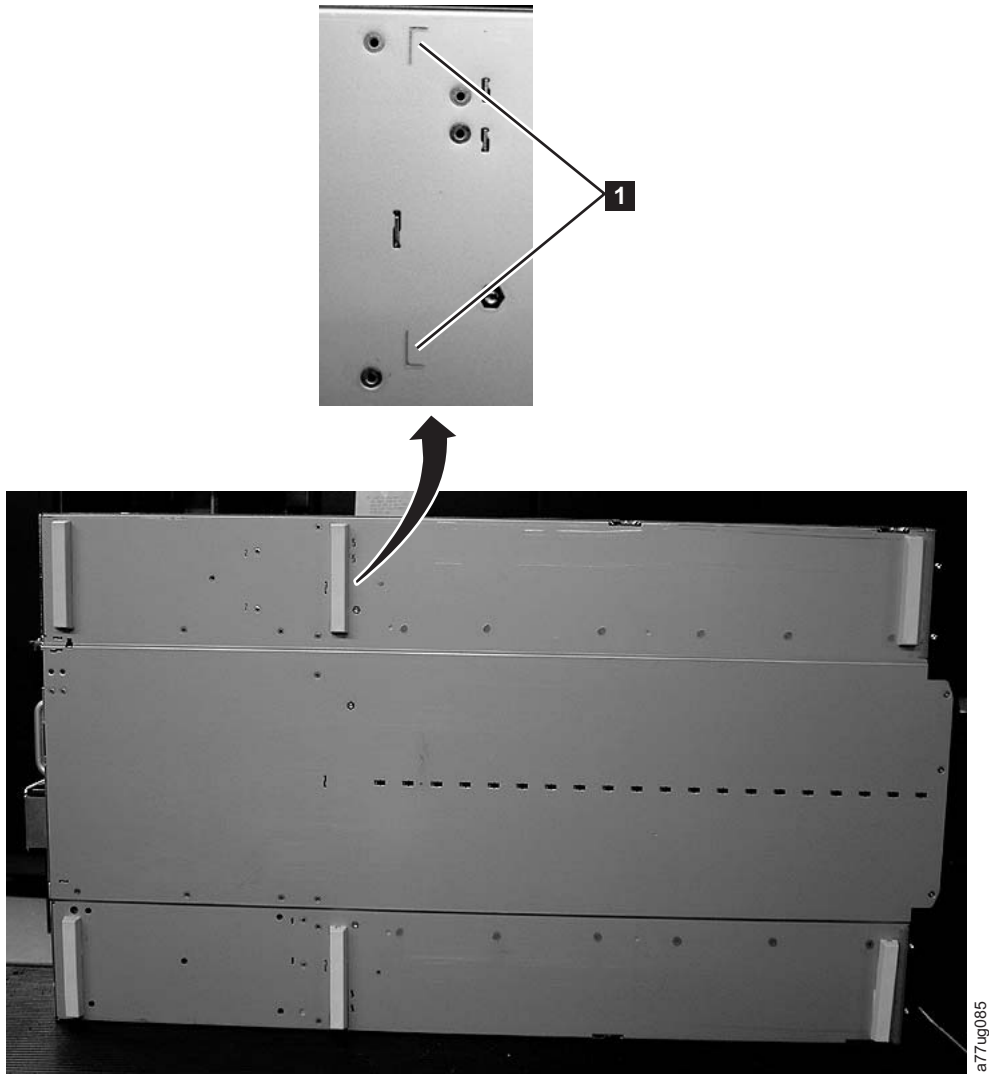

Figure 4-1. Installing foot pads on the bottom of the library enclosure

4. Carefully return the library to an upright position.

**Important:** Do not place any objects on top of the library.

## Removing and Storing the Shipping Lock

**Important:** The shipping lock, which prevents the library accessor from moving during shipment, **must be removed before the library is powered ON.**

The shipping lock is held in place with a label and is located in the top center of the library. After the shipping lock is removed, it should be stored on the right side of the back panel of the library for future use.

To remove and store the shipping lock:

1. Remove the blue label (**2**) that is securing the lock (**1**) to the top of the library, then remove the lock (see Figure 4-2 on page 4-5).



Figure 4-2. Shipping lock and label

2. Store the lock (1) and label (2) on the rear panel of the library as shown in Figure 4-3.



Figure 4-3. Library shipping lock and label storage location

## Rackmounting the Library (for Rack Installation ONLY)

The 2U library and the 4U library are easily installed into a standard 19-inch rack system. The 2U library requires 2U (3.5 in.) of space. The 4U library requires 4U (7 in.) of space.

If you are not rackmounting your library, skip this procedure and go to “Attaching the Library to a Server” on page 4-11.

**Important:** A 2U library weighs 15.59 kg (34.37 lbs.) with one drive and without media. A 4U library weighs 21.32 kg (47 lbs.) with one drive and without media.

To reduce the risk of personal injury or damage to the library:

1. observe local health and safety requirements and guidelines for manual material handling,
2. obtain adequate assistance to lift and stabilize the library during installation or removal, and
3. always remove all cartridges to reduce the overall weight of the library.

To install your library in a rack, perform the following steps.

1. Verify that your rack kit includes the following contents (see Figure 4-4 on page 4-7):
  - Packaged in plastic material:
    - 2 rails (not shown)
    - 2 mounting brackets ( **1** )
  - Packaged in the small bag with no label:
    - 1 Torx wrench ( **5** )
    - 2 anchors ( **4** )
    - 2 countersunk screws for securing the anchors ( **6** )
    - 2 small countersunk screws for securing the tops of the mounting brackets ( **7** )
    - 2 large screws to secure the mounting brackets to the rack ( **8** )
  - Packaged in the small bag with "Round Hole" on the label: 9 screws to be used on racks with round holes. ( **2** )
  - Packaged in the small bag with "Square Hole" on the label: 9 screws to be used on racks with square holes. ( **3** )

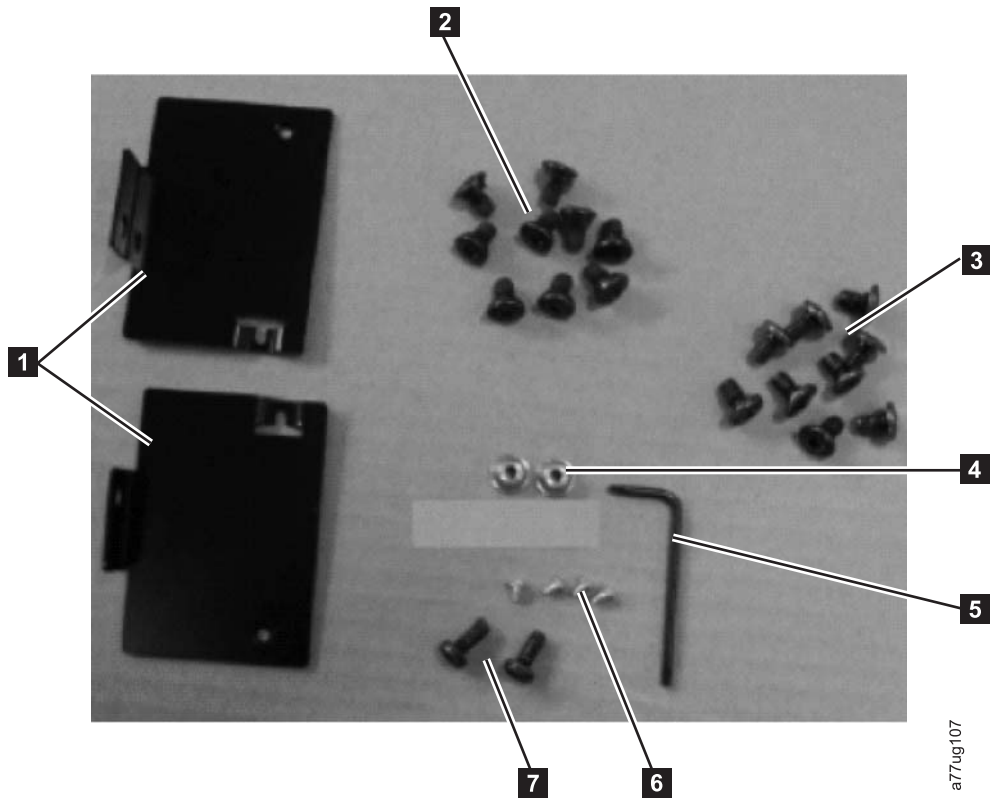

Figure 4-4. Rack Kit mounting hardware

2. Determine the location in your rack for your library to be installed and, using a pencil, mark the location on each vertical rail in your rack.

**Note:** A 2U library requires 2U (3.5 in.) of rack space. A 4U library requires 4U (7 in.) of rack space.

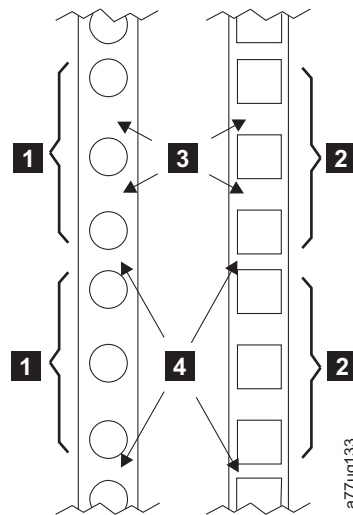

Figure 4-5. Examples of EIA units for round hole and square hole installations

<b>1</b>	Two EIA units for round hole and square hole installation	<b>3</b>	Wide Gaps <b>within</b> the EIA unit
<b>2</b>		<b>4</b>	Narrow Gaps <b>between</b> EIA units

- Using the screws for your rack type (round holes or square holes) and a #2 Phillips screwdriver and ensuring that the flange on each rail points toward the other to form a shelf, secure one rail to each side of the rack in your chosen rack location. Secure both the front and back of each rail to the rack. The narrow end of each rail goes to the rear of the rack. The rails extend to fit a variety of rack depths. Each rail requires 2U of rack space ( **1** in Figure 4-6).

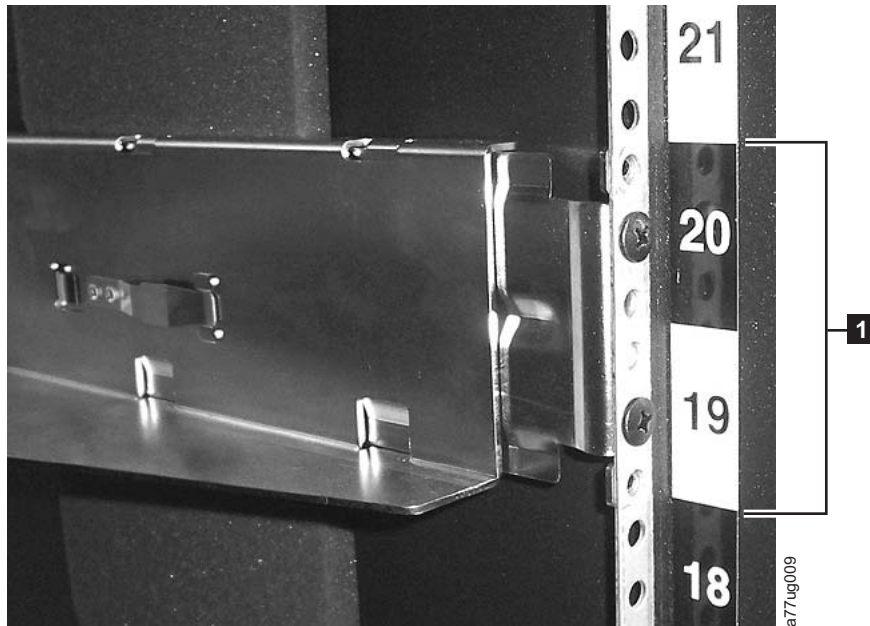

Figure 4-6. Rear view of a rack showing the narrow part of the rail

- Using the Torx wrench included in your shipment, remove the screws ( **1** ) as shown in Figure 4-7. Screw locations on the 4U library are similar.

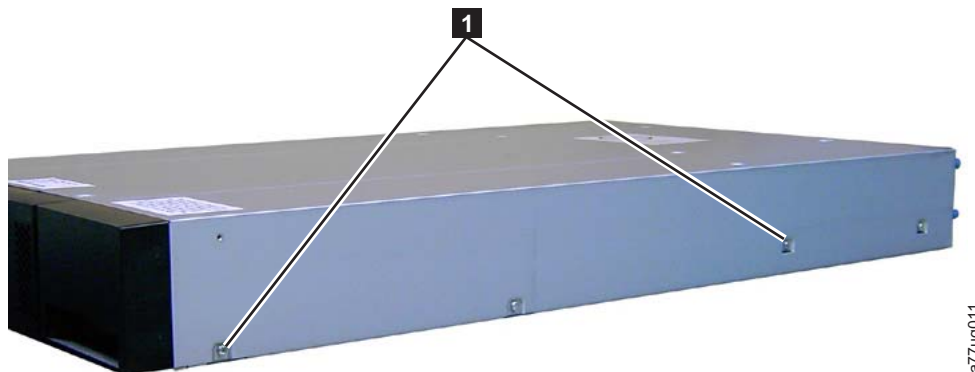
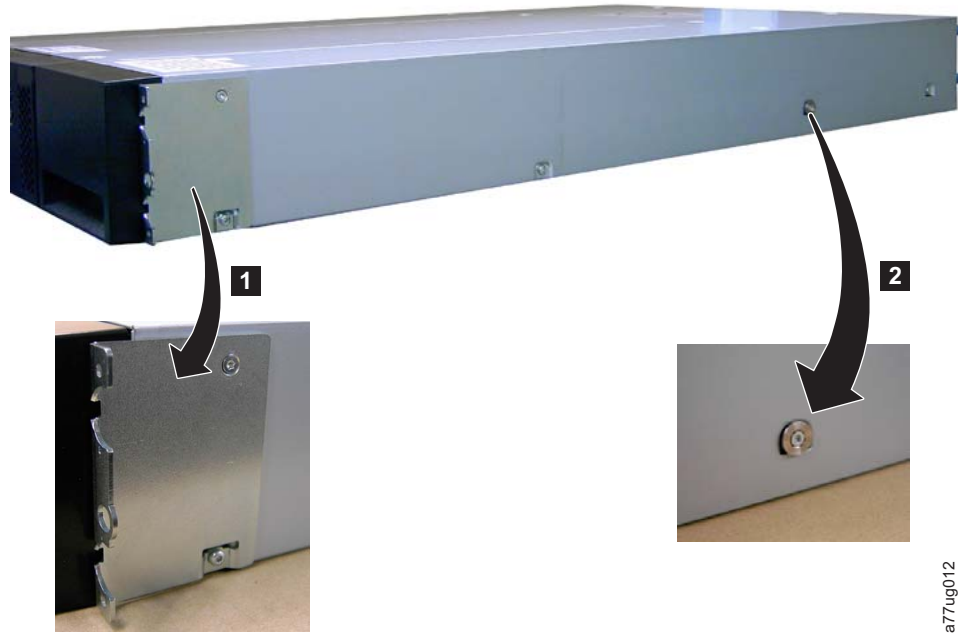

Figure 4-7. 2U library side screws to remove

- Install the library rack anchors ( **2** ) as shown in Figure 4-8 on page 4-9 on each side of your library using the longest counter-sunk screws included in the rack kit.





a77ug012

Figure 4-8. 2U library rack anchors and mounting brackets

6. Install the library mounting brackets ( **1** ) as shown on the 2U library on each side of the library using the screw that was removed from your library and an additional short, counter-sunk screw included in the rack kit. (The 4U rack anchors and mounting brackets are similar.)
7. With library rack anchors and mounting brackets installed, slide the library onto the rails (as shown in Figure 4-9 and Figure 4-10 on page 4-10). When the library stops, gently push the library to lock the anchors installed on each side of the library to the rails and until the mounting brackets are flush with the vertical rack rails.



a77ug127

Figure 4-9. Sliding the 2U library into the rack



a77ug109

Figure 4-10. Sliding the 4U library into the rack

- Using a #2 Phillips screwdriver, secure the library to the rack (see Figure 4-11 for a 2U library; see Figure 4-12 on page 4-11 for a 4U library) by placing a screw in the center hole of each mounting bracket and tightening them (**1**).



a77ug128

Figure 4-11. Securing the 2U library to the rack

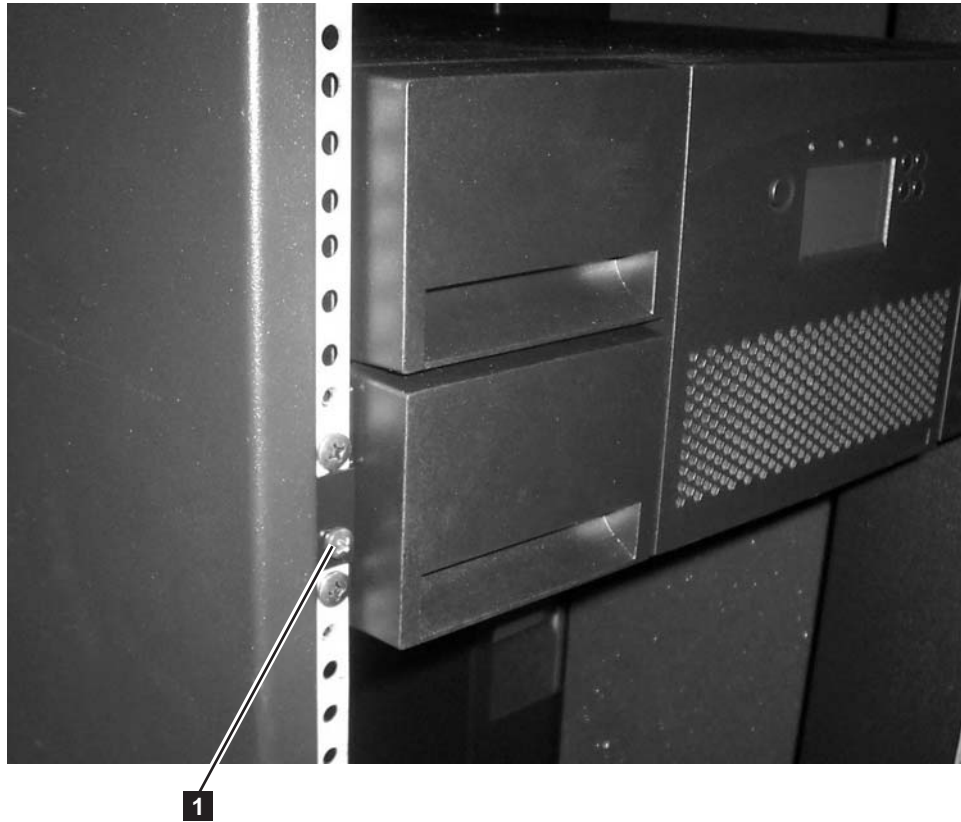

Figure 4-12. Securing the 4U library to the rack

### Attaching the Library to a Server

The 2U library and the 4U library can be attached to servers using the following interfaces:

- SCSI (LVD Ultra 160)
- Fibre Channel
- Serial Attached SCSI (SAS)

### Connecting the Host Interface Cable

To connect the host interface cables to the library:

1. It is recommended that you shut down and turn OFF the associated server. Turn OFF all attached devices. Remove the power cables from the server and all attached accessories.

**Important:** Failure to remove the power cords from these devices before connecting the host interface cable could result in damage to the library.

2. For a SCSI library, attach one end of the host interface cable to one of the connectors on the back panel of the library (see **1** in Figure 4-13 on page 4-12). For a Fibre Channel library, attach one end of the host interface cable to the connector on the back panel of the library (see **5** in Figure 4-14 on page 4-12). For a Serial Attached SCSI (SAS) connected library, attach the host end of the SAS cable to the SAS HBA (see **2** in Figure 4-15 on page 4-12). Full high drives will have dual SAS connectors. Half high drives will have one SAS

connector. Unused SAS connectors do not need to be terminated.

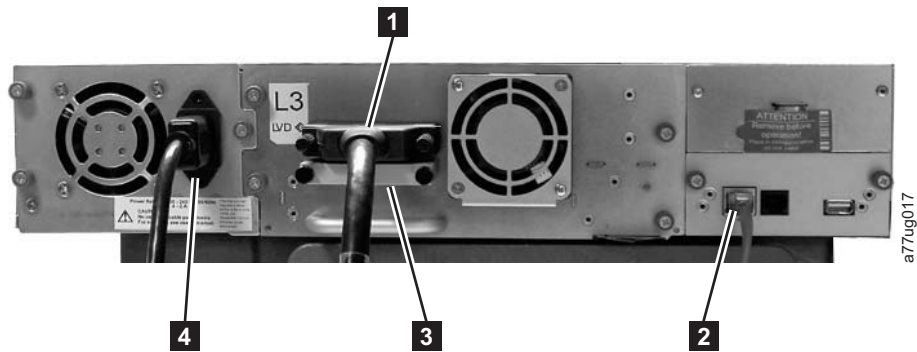

Figure 4-13. Attaching a SCSI host interface cable to the 2U library

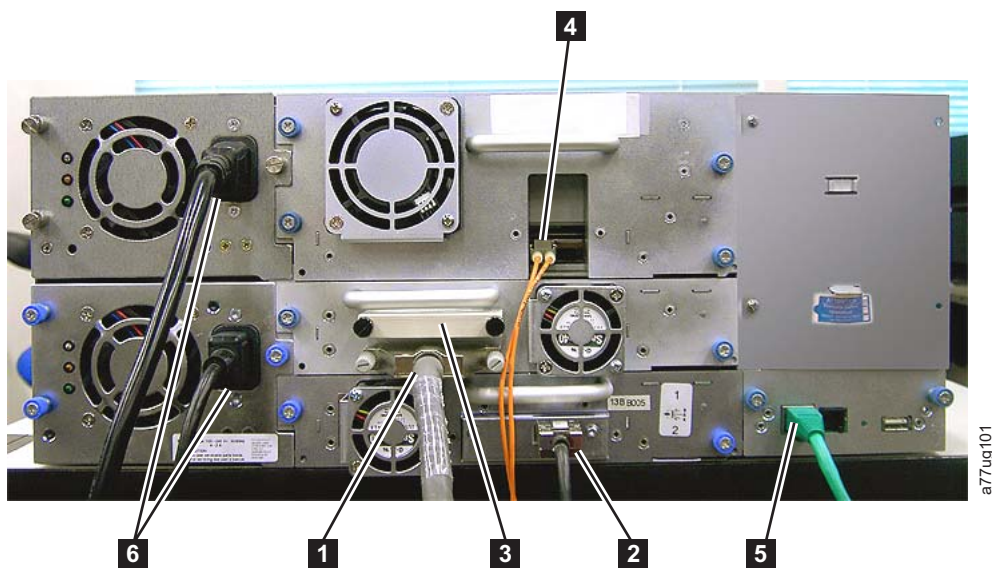

Figure 4-14. Attaching host interface cables to the 4U library. THE CONFIGURATION SHOWN IN THIS FIGURE IS USED FOR EXAMPLE ONLY. THIS CONFIGURATION IS NOT SUPPORTED.

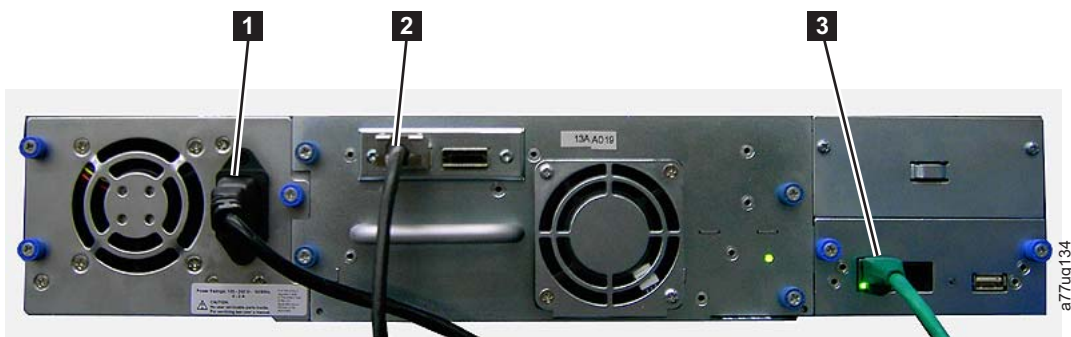

Figure 4-15. Attaching a SAS interface cable to the 2U library

3. Attach the other end of the host interface cable as follows:
  - For a SCSI library, connect the host interface cable to the connector on the SCSI host bus adapter or to the connector on the previous device on the SCSI bus. Attach the terminator (**3** in Figure 4-13) to the remaining SCSI connector on the back panel of the library, if the library is the last or only

device on the SCSI bus. Otherwise, attach one end of a SCSI cable to the remaining port and the other end to the next device on the SCSI bus. Make sure that the last device on the SCSI bus is properly terminated.

**Note:** Only cables and terminators specified for Ultra160 or Ultra320 use or labeled as Multi Mode should be used.

**Note:** The host bus adapter should be LVD SCSI. A single-ended (SE) SCSI host bus adapter will work, but will severely degrade performance, and limit cable length. If there are any SE devices on the same SCSI bus, the entire SCSI bus will negotiate down to SE speed and severely degrade performance.

- For a Fibre Channel library, connect the host interface cable to the host or to a switch.
  - For a SAS library, connect the Host Interface Cable to the host HBA, using a direct SFF-8088 connection, or an interposer as required. Unused SAS connectors do not need termination.
4. Plug the network ethernet cable **2** in Figure 4-13 on page 4-12, Figure 4-14 on page 4-12), or **3** in Figure 4-15 on page 4-12 into the ethernet port on the back panel of the library. If the ethernet connection is directly attached to a server or laptop, a crossover ethernet cable may be required.

**Note:** It is the customer's responsibility to supply the crossover cable if one is required.

## Connecting a Power Cord

**Attention:** This product can ONLY be used with an approved power cord for your specific geographic region. Use of an unapproved power cord may result in:

- not meeting individual country specific safety requirements;
- overheating with potential personal injury and/or property damage; and
- a fracture resulting in the internal contacts being exposed, which potentially could subject the user to a shock hazard.

For every power supply in the library, complete the following steps.

1. Remove the protective label from the power receptacle on your library.

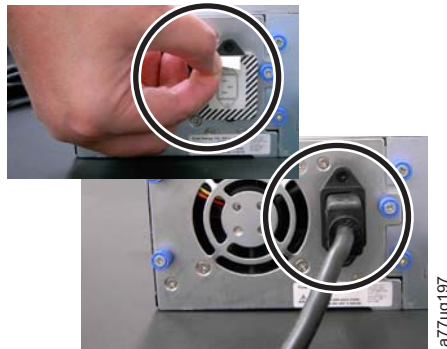

Figure 4-16. Removing the protective label from the power receptacle

2. Plug one end of the power cord ( **6** in “Connecting the Host Interface Cable” on page 4-11) into each power supply connector on the back panel of the library.
3. Plug the other end of each power cord into the nearest properly grounded power outlet. Use separate power sources for each power supply for redundant power.  
**Attention:** To disconnect all power from the library, remove the power cord from each outlet. The power button removes power from portions of the library and the drives, but the power supplies still have AC power at their inputs.
4. Remove the protective plastic on the exterior surfaces of the library.
5. Turn ON the library using the power button. Check the Operator Control Panel display to make sure the library is receiving power. If it is not, check the power connections and your power source. During the Power-On Self Test (POST), all four LEDs are illuminated briefly, followed by a flashing Ready LED. When the initialization sequence is complete, the Home screen will be displayed.

---

## Configuring Your Library

**Note:** Review the information in "Installation Planning" before configuring your library.

The library can be configured using the Operator Control Panel and/or the Web User Interface. The recommended method for configuring your library is using the Web User Interface.

### Choosing Your Configuration Method

If you choose to use the factory defaults for your library configuration, go to “Using Factory Defaults as Your Configuration.”

If you choose to use the Web User Interface for configuring your library, go to “Configuring Your Library using the Web User Interface” on page 4-15.

If you choose to use the Operator Control Panel for configuring your library, go to “Configuring Your Library using the Operator Control Panel” on page 4-31.

Write down all library configuration settings on the Appendix G, “Library Configuration Form,” on page G-1 for future reference.

### Using Factory Defaults as Your Configuration

The table below shows the main default library settings. If you wish to use the defaults, no other changes need to be made before using your library

Item	Default Setting
Logical Libraries	1
Active Slots	Maximum
I/O Slots	Enabled
DHCP	Enabled
Internet Protocol	IPv4 Only
Bar Code Label Length	8
Library Mode	Random

Item	Default Setting
AutoClean	Disabled
Encryption	Application Managed Encryption (AME)

For a full list of factory defaults, see “Configure: Save/Restore” on page 5-27.

## Configuring Your Library using the Web User Interface

To configure your library using the Web User Interface, complete the following procedures:

1. “Establishing Remote Access to Your Library”
2. “Logging on to the Web User Interface” on page 4-17
3. “Verifying/Updating Firmware” on page 4-18
4. “Choosing General Library Settings” on page 4-19
5. “Choosing the Number of Logical Libraries for Your Library” on page 4-20
6. “Entering Path Failover Feature Activation Key” on page 4-21
7. “Setting Up Encryption” on page 4-22
8. “Choosing Drive(s) Interface Identification/Settings” on page 4-24
9. “Entering Library Network Settings” on page 4-24
10. “Entering User Access Information using the Web User Interface” on page 4-26
11. “Entering Date and Time using the Web User Interface” on page 4-28
12. “Configuring Logs and Traces using the Web User Interface” on page 4-28
13. “Entering Email Notification Information using the Web User Interface” on page 4-29
14. “Configuring SNMP Settings” on page 4-29
15. “Testing Encryption Configuration for Library Managed Encryption” on page 4-30
16. “Restoring Factory Default Settings using the Web User Interface” on page 4-31
17. “Logging out of the Web User Interface” on page 2-8
18. “Setting the Operator Control Panel Access PIN using the Operator Control Panel” on page 5-26

## Establishing Remote Access to Your Library

Static library network settings must be entered using the Operator Control Panel before the library can be accessed remotely using the Web User Interface. If your system is serviced by DHCP (Dynamic Host Configuration Protocol) server, the network parameters will be automatically set. Once remote access has been established, you can complete the configuration of your library using the Web User Interface.

1. Access the **Configure** menu using the Operator Control Panel.
  - a. From the screen that shows the library logo (Home screen), press either the UP or DOWN button to get to the Main Menu.
  - b. Press the DOWN button to select **Configure**.
  - c. Press the SELECT button to display the **Configure** menu.
2. Press the DOWN button to highlight the **Network** menu.
3. Press the SELECT button to display the **Network** screen.

4. Select IP STACK, and press the SELECT button to highlight the Internet Protocol field.
  - a. Press the DOWN or UP button to scroll through the Internet Protocol options.
  - b. Press the SELECT button on the desired Internet Protocol.

If you select IPv6 protocol, the Configure Network menu will include options for Stateless Autoconfig and Prefix length.

  - Stateless Autoconfig:
    - Press the DOWN button to highlight Stateless Autoconfig.
    - Press the SELECT button to highlight the Stateless Autoconfig option field.
    - Press the DOWN button to scroll through the Stateless Autoconfig options.
    - Press the SELECT button to apply the option.
  - Prefix Length:
    - Press the DOWN button to highlight Prefix Length.
    - Press the SELECT button to highlight the Prefix Length option field.
    - Press the UP or DOWN buttons to scroll through the Prefix Length digits.
    - Press the SELECT button to apply the Prefix Length digits.
5. If you do **not** want to select DHCP as your library network setting, skip this step and proceed to the next step. If you want to select DHCP as your library network setting, complete the following steps:
  - a. Press the DOWN button to highlight DHCP.
  - b. Press the SELECT button to highlight the **DHCP** field.
  - c. Press the DOWN button to select **ON**.
  - d. Press the SELECT button to apply your selection.
  - e. Skip to Step 7.
6. Press the DOWN button to select **IP Address**. For IPv4 only, enter only an IPv4 address. For IPv6 only, enter only an IPv6 address. For IPv4 & IPv6, enter an IPv4 address and an IPv6 address.
  - a. Press the SELECT button to highlight the **IP Address** field.
  - b. Press the UP or DOWN button to select the digit(s) in the first octet of your library's IP Address.
  - c. Press the SELECT button to highlight the digit(s) in the next octet of your IP Address.
  - d. After entering the digits for the last octet, press the SELECT button to apply your entries.
7. Press the DOWN button to select **Netmask**. For IPv4, enter only an IPv4 Netmask address. For IPv6, enter only an IPv6 Netmask address. For IPv4 & IPv6, enter both IPv4 and IPv6 Netmask addresses.
  - a. Press the SELECT button to highlight the **Netmask** field.
  - b. Press the UP or DOWN button to select the digit(s) in the first octet of your library's Netmask address.
  - c. Press the SELECT button to highlight the digit(s) in the next octet of your library's Netmask address.
  - d. After entering the digits for the last octet of your Netmask address, press the SELECT button to apply your entries.



8. Press the DOWN button to select **Gateway**. For IPv4, enter only an IPv4 Gateway address. For IPv6, enter only an IPv6 Gateway address. For IPv4 & IPv6, enter a Gateway address for both IPv4 and IPv6.
  - a. Press the SELECT button to highlight the **Gateway** field.
  - b. Press the UP or DOWN button to select the digit(s) in the first octet of your library's Gateway address.
  - c. Press the SELECT button to highlight the digit(s) in the next octet of your library's Gateway address.
  - d. After entering the digits for the last octet in your Gateway address, press the SELECT button to apply your entries.
9. Press the DOWN button to select **Ethernet**.
  - a. Press the DOWN button to highlight the **Ethernet** field.
  - b. Press the SELECT button to highlight the Ethernet setting.
  - c. Press the DOWN button to select a new setting.
  - d. Press the SELECT button to apply the new setting.
10. Press the DOWN button to highlight SAVE. Press the DOWN again to highlight CANCEL. Continue to press the DOWN button to switch between SAVE and CANCEL.
  - If SAVE is highlighted, press the SELECT button to apply your new configuration. If changes were made to the Network settings, a pop-up menu will display the option to reboot the library or cancel the reboot. If you select CANCEL in the pop-up menu, you will need to power cycle the library for the network changes to be applied.
  - If CANCEL is highlighted, press the SELECT button to cancel all of your entries and return to the Configure menu.

## Logging on to the Web User Interface

To complete the configuration of your library using the Web User Interface, follow the steps below.

1. On your host computer, open an Internet browser.
2. In the browser address field, enter your library's IP Address.
  - a. For DHCP and/or Stateless Autoconfig, use the Operator Control Panel to determine the IP Address assigned to your library. Navigate to **Monitor** → **Library** → **Network**. Scroll down to the library address information and make note of the address. Enter the IP Address in your internet browser address field to access your library with the Web User Interface. The library address information may include one or more of the following address types:
    - IP Address (IPv4 static or DHCP)
    - Static IPv6 Address
    - Link Local IPv6 Address
    - Assigned IPv6 address (DHCP or Stateless Autoconfig)
  - b. For IPv4, enter your library's IP Address using the 0.0.0.0 format (four octets).
  - c. For IPv6, enter your library's IP Address using the following format: http://[0:0:0:0:0:0:0:0].
  - d. For Dual Stack IPv4 + IPv6, enter your library's IP Address for either IPv4 or IPv6.
3. When the login screen appears,

- a. Select **admin** for a User ID.
- b. Enter **secure** for a Password.

Figure 4-17. Log in screen on the Web User Interface

## Verifying/Updating Firmware

It is important to run the latest level of firmware. To ensure that you are running the latest levels of library firmware, drive firmware, and SNMP MIB (Management Information Base) file, complete this procedure.

1. Verify the SNMP MIB file currently installed on your SNMP server. Verify the levels of library and drive firmware currently installed on your library by completing the following steps:
  - a. Expand **Monitor Library** in the left navigation pane of the Web User Interface.
  - b. Click **Library Identity** and make note of the Firmware revision.
  - c. Click **Drive Identity** and make note of the Firmware revision.
  - d. Log out of the Web User Interface.

**Note:** The SNMP MIB file is an optional feature.

2. Download the latest library firmware, drive firmware, and SNMP MIB (Management Information Base) file from <http://support.dell.com>.

**Note:** The SNMP MIB file is an optional feature.

- a. Enter in your internet browser address field and press **Enter** on your keyboard.
- b. Compare the firmware level available on the web to those that you made note of in step 1. If you are running the latest levels of library and drive firmware, proceed to the next step. If you are not running the latest levels of library and drive firmware, download the firmware that needs to be updated to your library host.
3. Update library and drive firmware on your library, if necessary.
  - a. Enter the IP Address of your library in your internet browser address field and press **Enter** on your keyboard.
  - b. Log in to your library's Web User Interface.
  - c. Expand **Service Library** in the left navigation pane of the Web User Interface.
  - d. Click **Upgrade Firmware**.
  - e. Browse to the new firmware level on your host, then click **Update**. Do this for both library and drive firmware, if necessary.
4. Install the MIB file on your SNMP server. Refer to your server application documentation for instructions.

## Choosing General Library Settings

If your library contains only one drive or logical library, both general and specific settings will be combined into one table (see Figure 4-18 on page 4-20).

1. Expand **Configure Library** in the left navigation pane of the Web User Interface.
2. Click **General** and enter the following:
  - **Library Name** - Enter a name for your library.
  - **Library Mode** (select one of the following per logical library):
    - **Random**: In random mode, the library allows the server's (host's) application software to select any data cartridge in any order.
    - **Sequential**: In sequential mode, the library's firmware predefines the selection of the cartridges. After initialization, the firmware causes the library to select the first available cartridge found (counting from the I/O Station through the last slot in your library) for loading into the drive.

**Important:** If a Logical Library in Sequential Mode contains more than one drive, only the first drive in the Logical Library will be utilized.

- **Autoload**: Sequential mode with autoload mode ON loads the first available cartridge (slot with the lowest numerical value that contains a cartridge) automatically if the library powers ON with an empty drive.
- **Loop**: Sequential mode with loop mode ON loads the cartridge in the lowest numerical slot after the cartridge in the highest numerical slot has been filled and sent back to its home slot. This allows endless backup operations without user interaction.
- **Active Slots** - Select the number of active slots you would like to assign in your library. This item will affect the number of **Res. (Reserved) Slots** in your library. For more information refer to "Configuring I/O Stations and Reserving Slots" on page 5-65.

**Note:** Slots can be reserved so that they are invisible to the host. It may be necessary to reserve slots in order to match the number of available slots to the ISV software licensing. Slots will be reserved starting with the highest element address. If your library does not have a dedicated cleaning cartridge slot, and you desire to enable Auto Clean, you must designate a reserved slot which can be used to hold the cleaning cartridge.

- **I/O Station Enabled** - If checked, the I/O Station is enabled. If not, the first 3 slots (in a 4U library or the 1st slot in a 2U library) are configured as storage.
- **Auto Clean Enabled** - Automatically cleans drive when drive requests cleaning **and** cleaning cartridge is present in a reserved slot or a dedicated cleaning slot. All cleaning cartridges must have **CLN** as part of the bar code. The Universal Cleaning Cartridge has the bar code label CLNUxxLx.
- **Bar Code Label Length Reported to Host** - Choose between 6 and 8. With 6, the first six characters of the cartridge VOLSER (Volume Serial Numbers) will be reported to the host. With 8, All characters in the VOLSER (first six characters plus the two character media type identifier) will be reported to the host. For more information on bar code labels, see "Bar Code Label" on page 6-4.
- Click one of the following:

- **Refresh** - Click this button to update the current screen.
- **Apply Selections** - Click this button to submit the changes made to the screen.

General	
Library Name	<input type="text"/>
Library Mode	<input checked="" type="radio"/> Random <input type="radio"/> Sequential <input type="checkbox"/> Autoload <input type="checkbox"/> Loop
Active Slots	23 ▼
I/O Station Enabled	<input checked="" type="checkbox"/>
Auto Clean Enabled	<input type="checkbox"/>
Barcode Label Length Reported To Host	8 ▼

Refresh    Apply Selections

Figure 4-18. The 2U library Configure Library: General screen

General	
Library Name	<input type="text"/>
I/O Station Enabled	<input checked="" type="checkbox"/>
Auto Clean Enabled	<input checked="" type="checkbox"/>
Barcode Label Length Reported To Host	8 ▼

Extended Configuration for Logical Libraries	
<b>Logical Library 1</b>	
Library Mode	<input checked="" type="radio"/> Random <input type="radio"/> Sequential <input type="checkbox"/> Autoload <input type="checkbox"/> Loop
Active Slots	21 ▼
<b>Logical Library 2</b>	
Library Mode	<input checked="" type="radio"/> Random <input type="radio"/> Sequential <input type="checkbox"/> Autoload <input type="checkbox"/> Loop
Active Slots	23 ▼

Refresh    Apply Selections

Figure 4-19. Example: The 4U library Configure Library: General screen

3. If your library has more than one drive, proceed to “Choosing the Number of Logical Libraries for Your Library.” If your library has one drive, proceed to “Entering Path Failover Feature Activation Key” on page 4-21.

### Choosing the Number of Logical Libraries for Your Library

**Note:** Review the information in “Determining the Number of Logical Libraries” on page 3-1 before completing the procedure in this section.

If you have a 2U or 4U library with only one drive, or do not wish to partition your library, proceed to the next section, “Entering Path Failover Feature Activation Key” on page 4-21.

One cartridge magazine cannot be assigned to two logical libraries. If you partition a multi-drive library, each of the magazines must be assigned to a logical library on a magazine boundary. The entire magazine must be part of one logical library only.

**Note:** If you have a 2U library with two drives, you have the capability to have two logical libraries.

In a fully populated 4U library with four half height drives and four logical libraries, resource assignments will be as follows:

- Logical Library 1 will contain Drive 1 and the lower left cartridge magazine.
- Logical Library 2 will contain Drive 2 and the upper left cartridge magazine.
- Logical Library 3 will contain Drive 3 and the lower right cartridge magazine.
- Logical Library 4 will contain Drive 4 and the upper right cartridge magazine.

The I/O Station and slots reserved for cleaning cartridges, if any, are shared among all logical libraries.

1. Click **Configure Library** → **Logical Libraries** in the left navigation pane.

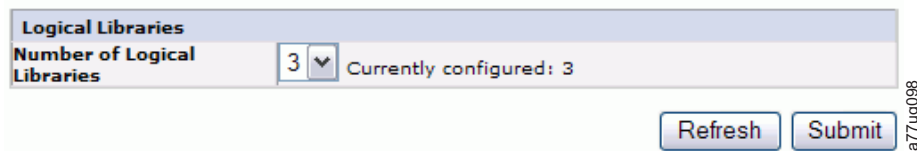

Figure 4-20. The 4U library Configure Library: Logical Libraries page

2. Select the number of logical libraries you would like to create in your library.
3. Click **Submit** to create the logical libraries.

## Entering Path Failover Feature Activation Key

For more information, refer to the *Dell PowerVault TL4000 Failover Configuration Guide*, included with the library documentation.

1. Click **Configure Library** → **Path Failover** in the left navigation pane.



Figure 4-21. The Configure Library: Path Failover Feature Activation screen

2. Enter the Control Path Failover 12-digit feature key in the spaces provided.
3. Click **Activate** to save the feature key. The following screen will display if you have correctly entered the feature key.

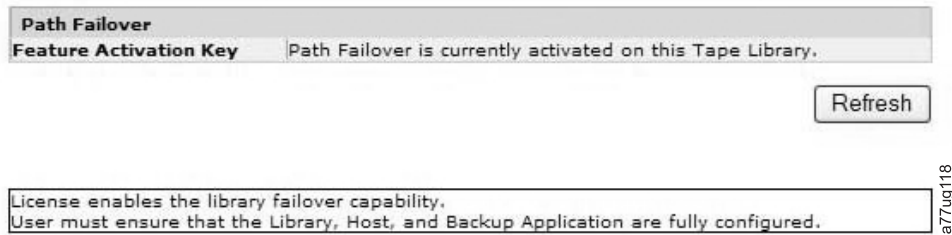

Figure 4-22. Feature Key verification screen

**Note:** Follow the instructions in the *Dell PowerVault TL4000 Failover Configuration Guide* to configure your environment for failover.

## Setting Up Encryption

**Note:** Application Managed Encryption (AME) does not require a key. Library Managed Encryption requires a license key. The customer should contact their TSR (technical sales representative) to purchase this feature.

Minimum Prerequisites for Application Managed Encryption:

- SAS and Fibre Channel LTO Ultrium 4 Tape Drive (Full Height or Half Height)
- Ultrium 4 Tape Cartridge
- Library firmware level 5.80 or higher
- Drive firmware level 77BE or higher
- Tape backup software application that supports LTO4 encryption

Minimum Prerequisites for Library Managed Encryption:

- SAS and Fibre Channel LTO Ultrium 4 Tape Drive (Full Height or Half Height)
- Ultrium 4 Tape Cartridge
- Library firmware level 5.80 or higher
- Drive firmware level 77BE or higher
- Dell Encryption Key Manager application

### Setting a Drive's Method of Encryption

1. Click **Configure Library** → **Encryption** in the left navigation pane.

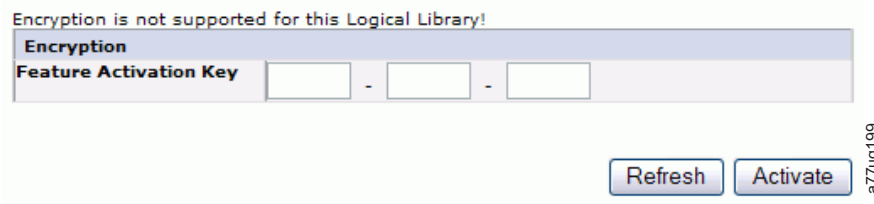

Figure 4-23. Feature Activation Key screen

2. On the **Encryption** screen, enter the **Feature Activation Key** to make available the library managed encryption options.
3. Click **Activate** to save the key and expand the screen for additional encryption settings.



Figure 4-24. Configure Library: Encryption Activation screen

4. Select **Enable SSL for EKM** to enable Secure Sockets Layer for the Dell Encryption Key Manager application.
5. Select an **Encryption method** for each logical library.
  - Without an encryption license key, select **None** or **Application Managed Encryption**.
  - With an encryption license key, select **Library Managed Encryption**.
6. Select an **Encryption policy** for each logical library.
  - **Encrypt All**: This is the default policy. It encrypts all cartridges using the default data keys specified in the EKM. This setting applies to all drives in a TL2000/TL4000 logical library.
  - **Internal Label - Selective Encryption**: Check your tape backup software application documentation to see if this feature is supported.
  - **Internal Label - Encrypt All**: Check your tape backup software application documentation to see if this feature is supported.
7. A primary and secondary EKM server can be set for each logical library. Each partition has its own Encryption and EKM settings. Maintaining primary and secondary EKM servers is desired for maximum availability of encrypted backup and recovery. These settings are required for Library Managed Encryption only. Enter the **EKM Server Setting** information.

**Note:** The IP address of the Encryption Key Manager (EKM) host must be consistent with the library Network settings. This means if the library is set to **IPV4 only** network support, the EKM host must be an IPv4 address. If the Dell PowerVault library is required to function in a mixed network environment the library must be set to **IPv4 + IPv6**.

- **Primary IP address (IPv4 or IPv6)**: Enter the IP address of the primary EKM server.
- **Primary TCP port**: After entering the Primary IP address, the library will automatically set the value of the Primary TCP port.
- **Secondary IP address (IPv4 or IPv6)**: Enter the IP address of the secondary EKM server.
- **Secondary TCP port**: After entering the **Secondary IP address**, the library will automatically set the value of the **Secondary TCP port**.

**Note:** The Default Port for TCP (SSL disabled) is **3801**. The Default Port for SSL is **443**. These values are the default values set by the library. They can be changed depending on the user configuration but the user has to make sure they match the EKM properties file.

**Note:** If SSL is enabled the encryption host configuration will request a SSL port instead of a TCP port. Review your *Dell PowerVault Encryption Key Manager User's Guide* for instructions to locate the appropriate port settings.

8. Click **Activate** to apply the changes.

9. Install the Dell Encryption Key Manager (EKM) application on your host. Refer to the Dell EKM documentation provided with your Encryption packet. The EKM IP address and EKM port will be provided to the user by the EKM application.

### Choosing Drive(s) Interface Identification/Settings

1. Click **Configure Library** → **Drives** in the left navigation pane.

Drives	
Drive 1 (Logical Library 1)	<input checked="" type="checkbox"/> Power On <input checked="" type="checkbox"/> Control Path Note: SAS drives do not require user configuration
Drive 2 (Logical Library 2)	<input checked="" type="checkbox"/> Power On <input checked="" type="checkbox"/> Control Path
SCSI ID	6
Drive 3 (Logical Library 3)	<input checked="" type="checkbox"/> Power On <input checked="" type="checkbox"/> Control Path
<b>Port A Configuration</b>	
Speed	Automatic
Topology	LN-Port
FC-AL Loop ID	6
<b>Port B Configuration</b>	Port not available

Refresh Submit

a77ug095

Figure 4-25. The Configure Library: Drive screen

2. Select the desired settings for each drive listed (either SCSI, SAS, or Fibre Channel). See Figure 4-25.
3. Click one of the following:
  - **Refresh** - to update the current screen
  - **Submit** - to apply the changes made to the screen

### Entering Library Network Settings

This page shows the current network configuration of the library and allows modification to the configuration. When a change is requested, a pop-up box confirms the request.

1. Click **Configure Library** → **Network** in the left navigation pane, to display the **Network** page.



Network	
Protocol Stack	IPv4 only
Host Name	FLX1068B0
Domain Name	storage.tucson.ibm.com
DNS Primary	9.11.224.130
DNS Secondary	9.11.224.114
Enable SSL For Web	<input type="checkbox"/>
Ethernet Settings	Auto
IPv4	
Enable DHCP	<input type="checkbox"/> On
Static Address	9.11.219.162
Network Mask	255.255.255.0
Gateway address	9.11.219.1
IPv6	
Enable DHCP	<input type="checkbox"/>
Enable Stateless Auto Config	<input checked="" type="checkbox"/>
Static Address	0:0:0:0:0:0:0:0
Prefix length	64
Gateway address	0:0:0:0:0:0:0:0

 You will be required to login again, or reboot the library, if changes are made. If you change the IP address of the library, you will need to use the new IP address when you attempt to access the library again.

a77ug074

Figure 4-26. Configure Library: Network Page

**Important:** Do not click the Submit button until all changes have been made to the Network page. Once the Submit button has been clicked, no other changes can be made until after the library has applied the current changes.

After the Submit button has been clicked, depending on the changes made, you will either be disconnected and need to login again or reboot the library.

Clicking the Refresh button will refresh the page and any changes made will not be retained.

2. Select a **Protocol Stack** - Choose **IPv4 only**, **IPv6 only**, or **Dual Stack IPv4 & IPv6**.

If you choose **Dual Stack IPv4 & IPv6**, you must be prepared to enter both IPv4 and IPv6 IP addresses. The sections below will gray out depending on the choices made here.

3. Enter the **Host Name**.
4. Enter the **Domain Name**.
5. **DNS Primary** - Enter the IP address of your primary DNS server.
6. **DNS Secondary** - Enter the IP address of your secondary DNS server.
7. **Enable SSL for Web** - If you desire to have SSL (Secure Sockets Layer) enabled, place a check in this box.

**Note:** If you get a security certificate alert when logging in to the Web User Interface, you can install the certificate or allow an exception (depending on the internet browser you are using). SSL is enabled when the URL begins with **https://** and some browsers will show a lock.

8. **Ethernet Settings** - Ethernet Settings choices are: **Auto** (the default), **10 Mbit/Half**, **10 Mbit/Full**, **100 Mbit/Half**, **100 Mbit/Full**. Please refer to <http://support.dell.com> to determine the availability of manual Ethernet settings in your library's firmware.
9. **Enter IPv4 settings (if applicable).**
  - a. **Enable DHCP** - Click this item ON to have the IP Address of your library automatically set by the DHCP server.
  - b. **Static Address** - Enter the assigned IPv4 address. The format of an IPv4 address is a 32-bit numeric address written as four numbers separated by periods.
  - c. **Network Mask** - Enter the assigned IPv4 Network Mask.
  - d. **Gateway address** - Enter the assigned IPv4 Gateway address. This address allows access outside the local network.
10. **Enter IPv6 settings (if applicable).**
  - a. **Enable DHCP** - Click this item ON to have the IP Address of your library automatically set by the DHCP server.
  - b. **Enable Stateless Auto Config** - Stateless Auto config is ALWAYS on (not defeatable).
  - c. **Static Address** - Enter the assigned IPv6 address. The format of an IPv6 IP address is a 128-bit numeric address written as 8 groups of four numbers separated by colons.
  - d. **Prefix length** - The default prefix length is set to 64, but can be set to any length, depending upon the address used.
  - e. **Gateway address** - Enter the assigned IPv6 Gateway address. This address allows access outside the local network.
11. Click one of the following:
  - **Refresh** - to cancel the changes made to the screen.
  - **Submit** - to apply the changes made to the screen.

**Note:** Depending on the changes made, you will either be disconnected and need to login again, or reboot the library. If a reboot is required, the following Warning message will appear after the Submit button is clicked.

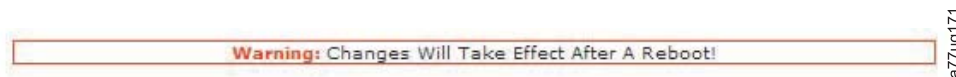

Figure 4-27. Warning Screen

The library must be rebooted or the changes will not take place.

## Entering User Access Information using the Web User Interface

The **Configure Library** → **User Access** page is only accessible to the Admin and Service login. Access is denied to User and Superuser logins.

The Admin login has access to all library functions except **Service Library** → **Advance Diagnostics**.

The Service login has access to all library functions including **Service Library** → **Advance Diagnostics**.

1. Click **Configure Library** → **User Access** in the left navigation pane.

The screenshot shows a web form titled "Configure Library: User Access". It is organized into several sections:

- Roles:** Contains two checkboxes: "Disable Superuser" and "Disable User".
- Passwords:** Contains a "Role" dropdown menu with "User" selected, a "New Password (Enter Up To Ten Characters)" field with ten dots, and a "Repeat Password" field with ten dots.
- Support Contact:** Contains three text input fields: "Support Name", "Support Phone", and "Support Email".

At the bottom right of the form are two buttons: "Refresh" and "Submit". A vertical watermark "a77ug082" is located on the right side of the form.

Figure 4-28. The Configure Library: User Access screen

2. Check the **Disable Superuser** checkbox to disable the Superuser role for this library. Check the **Disable User** checkbox to disable the User role for this library. Uncheck these boxes to allow these roles access to your library.
3. Choose a Role.

**Note:** Admin can select User, Superuser, and Admin roles. Service can select User, Superuser, Admin, and Service roles.

- User (if enabled)
- Superuser (if enabled)
- Admin
- Service

**Note:** Only one password can be set for each Role.

4. Enter the **New Password** . The password has a maximum of 10 characters (A-Z, a-z, 0-9, @, <hyphen>, <space>, <period>).
5. In **Repeat Password**, enter the new password again.
6. In **Support Name**, enter the name of the person that will be able to offer the user help with the library.

**Note:** Only one support person can be configured for the entire tape library. The support person may or may not be one of the user, superuser, or admin account holders.

7. In **Support Phone**, enter the phone number of the person that will be able to offer the user help with the library.
8. In **Support Email**, enter the email address of the person that will be able to offer the user help with the library.
9. Click one of the following:
  - **Refresh** - to update the current screen.
  - **Submit** - to apply the changes made to the screen.

## Entering Date and Time using the Web User Interface

1. Click **Configure Library** → **Date & Time** in the left navigation pane.

Date & Time	
Time (24H)	17 : 41 : 11
Date	Month : 04 Day : 11 Year : 2006

Figure 4-29. The Configure Library: Date and Time screen

2. Enter the current **Time** using the HH:MM:SS 24-hour format.
3. Enter the current **Date** using the MMDDYYYY format.
4. Click one of the following:
  - **Refresh** - to cancel all of your entries and leave the settings as they were.
  - **Submit** - to apply the changes made to the screen.

## Configuring Logs and Traces using the Web User Interface

This function is not available on the Operator Control Panel.

1. Click **Configure Library** → **Logs & Traces** in the left navigation pane.

Logs & Traces	
<b>Error Log Mode</b>	<input checked="" type="radio"/> Continuous <input type="radio"/> Stop Trace At First Error <input type="radio"/> Stopped
<b>Trace Level</b>	<input checked="" type="checkbox"/> Cmd <input checked="" type="checkbox"/> Response <input checked="" type="checkbox"/> Event <input checked="" type="checkbox"/> Trace Data <input checked="" type="checkbox"/> Low Level Trace <input checked="" type="checkbox"/> Recovered Error <input checked="" type="checkbox"/> Hard Error
<b>Trace Filter</b>	<input checked="" type="checkbox"/> Main <input checked="" type="checkbox"/> Drive <input checked="" type="checkbox"/> CDB Interpreter <input checked="" type="checkbox"/> Robotic <input checked="" type="checkbox"/> Trace <input checked="" type="checkbox"/> OCP Input <input checked="" type="checkbox"/> OCP Output <input checked="" type="checkbox"/> SCSI Module <input checked="" type="checkbox"/> SDCI Module

Figure 4-30. The Configure Library: Logs and Traces screen

2. For Error Log Mode, select **Continuous** so all information for logs and traces will be captured.
3. Trace Level and Trace Filter options can be changed by Service personnel only.
4. Click one of the following:
  - **Refresh** - to cancel all of your entries and leave the settings as they were.
  - **Submit** - to apply the changes made to the screen.

## Entering Email Notification Information using the Web User Interface

This function is not available on the Operator Control Panel.

Use this menu item to set up email notification of library errors and warnings.

1. Click **Configure Library** → **Email Notification** in the left navigation pane.



Email Notification	
Notify Errors	<input type="checkbox"/> On
Notify Warnings	<input type="checkbox"/> On
To Email Address	<input type="text"/>
SMTP Server Address (IPv4)	<input type="text" value="d03av02.boulder.ibm.com"/> IPv4 address or Host name and domain *
Domain Name	<input type="text" value="storage.tucson.ibm.com"/>

Refresh Submit a77ug065

Figure 4-31. The Configure Library: Email Notification screen

2. If you would like to be notified when an error occurs, select **Notify Errors**.
3. If you would like to be notified when a warning occurs, select **Notify Warnings**.
4. In **To Email Address**, enter the email address to which the information will be sent.
5. In **SMTP Server Address (IPv4 or IPv6)**, enter the IP Address of the SMTP server associated with the email address.
6. Enter the **Domain Name** for your library. This field cannot be blank when using event notification.

**Note:** If you attempt to enter a blank value for the Domain Name, a warning message will appear. It will say **If you are using Event Notification then a value is required for the Domain Name**.

7. Click one of the following:
  - **Refresh** - to cancel all of your entries and leave the settings as they were.
  - **Submit** - to apply the changes made to the screen.

### Configuring SNMP Settings

This page shows the current SNMP configuration of the library and allows modification to the configuration. When a change is requested, a pop-up box checks to confirm the changes.

1. Click **SNMP** in the left navigation pane, to display the **SNMP** page.

SNMP	
Enabled	<input checked="" type="checkbox"/>
Target 1 - IP Address	9.11.219.229 <span style="float: right;">Version SNMPv2</span>
	<small>IPv4 address or Host name and domain *</small>
Target 2 - IP Address	0.0.0.0 <span style="float: right;">Version SNMPv2</span>
	<small>IPv4 address or Host name and domain *</small>
Target 3 - IP Address	0.0.0.0 <span style="float: right;">Version SNMPv3</span>
	<small>IPv4 address or Host name and domain *</small>
Community Name	public
Security User Name	initial
Audit Logging	<input checked="" type="checkbox"/>

a77ug278

Figure 4-32. Configure Library: SNMP Page

2. Enter SNMP settings.
  - a. **Enabled** - Check this box to have SNMP traps sent to a SNMP Management console(s).
  - b. **Target 1-IP Address** - If SNMP traps are enabled, enter an IP address where SNMP traps are to be sent.
  - c. **Target 2-IP Address** - Enter an optional 2nd IP address where SNMP traps are to be sent, or leave as 0.0.0.0.
  - d. **Target 3-IP Address** - Enter an optional 3rd IP address where SNMP traps are to be sent, or leave as 0.0.0.0.
  - e. **Version** - The library offers three versions of the SNMP protocol; v1, v2 and v3. Select a version for each Target IP Address.
  - f. **Community Name** - An SNMP community name is a text string that acts as a password to authenticate messages sent between the SNMP remote management application and the library. Enter your preferred name, or leave as "public". The Community Name is limited to 33 alpha-numeric characters (A-Z, a-z, 0-9).
  - g. **Audit Logging** - If SNMP is enabled and Audit Logging is enabled, the library will send SNMP traps to an SNMP Management console(s) when the library or tape drive configuration has changed.

**Note:** This option is only available if the library firmware is 9.00 or higher, and the latest library MIB file has been added to the SNMP Management console.
3. Click one of the following:
  - **Refresh** - to cancel the changes made to the screen.
  - **Submit** - to apply the changes made to the screen.

## Testing Encryption Configuration for Library Managed Encryption

Please refer to <http://support.dell.com> to determine the availability of this feature.

If you have purchased an encryption activation key and any LTO 4 Fibre Channel or SAS drives in your library are configured for library managed encryption, run the Key Path Diagnostic to ensure that your encryption configuration is correct.

**Important:** Ensure that library firmware and drive firmware are up to date before running the Key Path Diagnostic. Library firmware level must be greater than 6.xx. See "Verifying/Updating Firmware" on page 4-18.

For information on running the diagnostic, refer to “Service Library: Key Path Diagnostics” on page 5-61.

## Restoring Factory Default Settings using the Web User Interface

If you would like to erase your current configuration and restore factory default settings, do so by selecting **Restore Factory Defaults** in the **Configure Library** → **Save/Restore** menu. See “Configure Library: Save/Restore Configuration” on page 5-56.

The factory default settings are listed in Table 5-4 on page 5-28.

## Logging out of the Web User Interface

To log out of the Web User Interface, click **Logout** in the upper right corner of the current screen.

**Important:** If you click the **X** in the upper right corner of your internet browser window, you will not log out of the Web User Interface.

## Configuring Your Library using the Operator Control Panel

If you choose to use the Operator Control Panel for configuring your library, go to “Configure Menu” on page 5-18 for information on configuring the following items:

- Logical Libraries
- Library Settings
- Drive(s)
- Network
- Set Access PIN
- Set Date and Time
- Path Failover

To complete the configuration of your library, the following items will have to be accessed from the Web User Interface:

- Encryption (if purchased) (see “Configure Library: Encryption” on page 5-47)
- User Access Information (see “Configure Library: User Access” on page 5-52)
- Logs and Traces (see “Configure Library: Logs & Traces” on page 5-54)
- Event Notification Information (see “Configure Library: Email Notification” on page 5-55)
- Key Path Diagnostic (if Encryption was purchased) (see “Service Library: Key Path Diagnostics” on page 5-61)
- Updating Firmware (see “Service Library: Upgrade Firmware” on page 5-62)

---

## Preparing the Host

Follow these general guidelines:

1. Make sure that your backup application supports the SCSI, SAS, or Fibre Channel host bus adapter (HBA).
2. If the host server is connected to a network, check with the system administrator before turning host power OFF.

3. Install a suitably rated HBA. Remember that if there are any single-ended (SE) devices on the same SCSI bus, the entire SCSI bus will negotiate down to SE speed and severely degrade performance and limit cable length.
4. Make sure that LUN scanning is enabled on the SCSI host adapter.
5. Make sure that Fibre Channel Tape Support is enabled on the Fibre Channel HBA if installing a library with a Fibre Channel drive.
6. Make sure that SAS support is enabled on the SAS HBA if installing a library with a SAS drive.

---

## Verifying the Connection

1. Depending on the server configuration, you may need to change the SCSI ID, SAS, or Fibre Channel Loop ID of the library, if the current ID is the same as another device on the bus.
2. When the host server is powered ON, install the software and/or driver(s) that are compatible with the library. Backup software packages may require additional software or licensing to communicate with the library accessor.
3. If this is a SCSI attachment, ensure the library is properly terminated. If the library is the only SCSI device, other than the SCSI host adapter on the selected SCSI bus, it must be terminated. Likewise, if the library is physically the last SCSI device on the SCSI bus, it must be terminated. Only the devices physically located at the beginning and end of the SCSI bus should be terminated.
4. Confirm that the host server operating system recognized the library. In Microsoft Windows XP or Windows Server 2003, you can verify this by going to: **Settings** → **Control Panel** → **System** → **Hardware** → **Device Manager** → **Tape Drive and/or Medium Changer** .

For more information on verifying the connection of SCSI devices, consult the operating system documentation.

---

## Cartridge Magazines

The library has removable magazines. Magazine access is password protected. For safety reasons, the accessor motion is stopped when a magazine is removed.

The magazines can be released using the Operator Control Panel or the Web User Interface. In case the Operator Control Panel or Web User Interface initiated process has failed or the library no longer has power, a manual emergency release is available.

**Important:** To manually release a magazine, . This manual process should only be used if the magazine cannot be released using the Operator Control Panel or the Web User Interface.

### 2U Library Cartridge Magazines

The 2U library has two cartridge magazines. The left cartridge magazine (see Figure 4-33 on page 4-33) has eleven storage slots and houses the elective 1-slot I/O Station. The right magazine (see Figure 4-34 on page 4-33) has twelve storage slots. For information about Element Addressing, .





a77ug241

Figure 4-33. 2U library left magazine



a77ug242

Figure 4-34. 2U library right magazine

## 2U Library I/O Station

The I/O (Input/Output) Station (see Figure 4-35 on page 4-34) in a 2U library is part of the left magazine. To open the I/O Station, select **Control** → **Open I/O Station**. The I/O Station will pop open. To close the I/O Station, gently push it back into the left magazine.



a77ug248

Figure 4-35. 2U library I/O Station in the left magazine

## 4U Library Cartridge Magazines

The 4U library has four cartridge magazines, two on each side (see Figure 4-36 and Figure 4-37 on page 4-35). The upper left magazine has twelve storage slots. The lower left magazine has nine storage slots and houses the elective 3-slot I/O Station ( **1** in Figure 4-36). The upper right magazine has twelve storage slots. The lower right magazine has twelve storage slots. For information on Element Addressing, .



a77ug245

Figure 4-36. 4U library left magazines

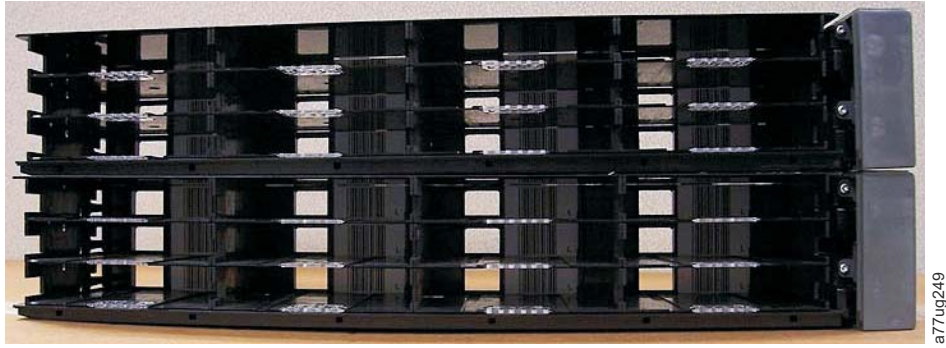

Figure 4-37. 4U library right magazines

### 4U Library I/O Station

The I/O Station in a 4U library (see Figure 4-38) is part of the lower left magazine. To open the I/O Station, select **Control** → **Open I/O Station**. The I/O Station will pop open. To close the I/O Station, gently push it back into the lower left magazine.



Figure 4-38. 4U library I/O Station in the lower left magazine

There are finger holes on the back side of the I/O Station (see **1** in Figure 4-39 on page 4-36) that allow the user to push the cartridges out of the I/O station.

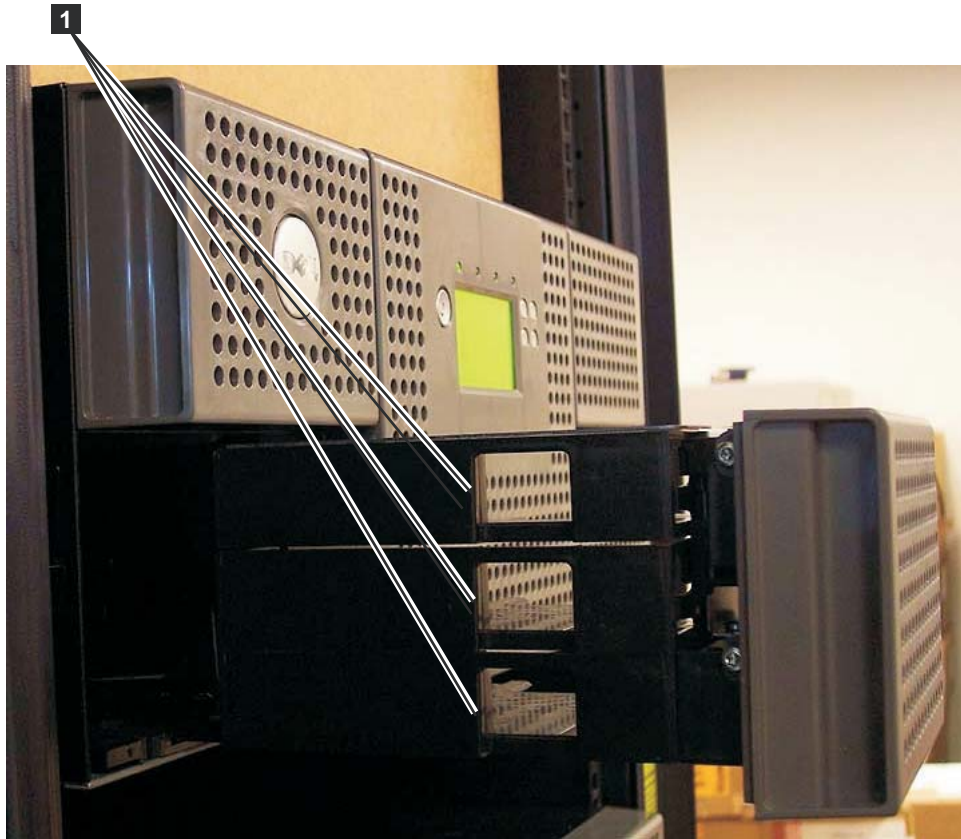

Figure 4-39. Finger Holes on back side of 4U library I/O Station

## Populating the Library with Data Cartridges

For information on working with the cartridge magazines, see “Cartridge Magazines” on page 4-32.

1. Properly label the data cartridges. Refer to Chapter 6, “Using Ultrium Media,” on page 6-1.
2. Unlock the cartridge magazines.
  - Using the Operator Control Panel: **Control** → **Magazines** select Left or Right.
  - Using the Web User Interface: **Manage Library** → **Release Magazine** select Left or Right.

**Note:** The magazines will relock after 15 seconds if they have not been removed.

3. Remove the selected magazines from the library.
4. Insert cartridges in the magazine(s). Do not store cartridges in the I/O Station or in the dedicated cleaning cartridge slot.
5. Put magazines back into the library. The library will automatically start up and perform an inventory check.

## Inserting the Cleaning Cartridge

**Note:** Earlier versions of the 4U library contained a **Dedicated Cleaning Slot (DCS)**. This DCS can be retained and is supported by future library firmware updates. However, library firmware later than 3.90 will allow removal of the DCS, thus enabling this slot to be used as a storage slot. Once the DCS is removed, the Auto Clean cleaning cartridge slot must be configured as described below. If the DCS has been removed, it can only be reinstated by restoring factory default settings. To remove the DCS, perform the following procedure using the Operator Control Panel (OCP):  
**OCP->Configure->Library Settings->General->Remove DCS->No/Yes->Save.**

The following criteria must be followed for **Auto Clean** to function:

1. A storage slot must be reserved (Res or RSVD).
  - Reserving a slot is accomplished by reducing the **Active Slot** count in any particular logical library. A reserved slot (or slots) is always the last slot in the last magazine of any particular logical library. A cleaning cartridge that is in a reserved slot is available to any logical library drive even if the reserved slot is not in that particular logical library. If the library contains multiple logical libraries, typically, the last logical library is chosen to be the reserved slot containing the cleaning cartridge. As with a library with a single logical library, this slot is the last physical slot in the library (top right magazine, uppermost rear slot).
2. The **Auto Clean** function must be **Enabled**.
  - Operator Control Panel: **Configure->Library Settings->Auto Clean: Enabled**
  - Web User Interface: **Configure Library->General->Auto Clean Enabled->check box**

**Note:** Enabling Auto Clean without first reserving a slot for the cleaning cartridge will result in the library System Status screen (web UI) reporting the following attention conditions:

- Media Attention
  - Chk Media/Rsvd Slot
3. To install a cleaning cartridge in the 2U or 4U library:
    - a. Properly label the cleaning cartridge (CLNxxxLx). Refer to Chapter 6, "Using Ultrium Media," on page 6-1.
    - b. Place the cleaning cartridge in the library using the same procedure described in "Populating the Library with Data Cartridges" on page 4-36. Ensure the cleaning cartridge is placed in a reserved slot or the DCS (if one exists, 4U only).
    - c. If the cleaning cartridge is not in a reserved slot, use the Operator Control Panel: **Control → Move Cartridge** or the Web User Interface: **Manage Library → Move Media** to move the cleaning cartridge into the reserved slot or the DCS (if one exists, 4U only).

**Note:** A user has the option to perform manual cleaning by navigating in the RMU to **Service → Clean Drive**. In units with more than one drive to be cleaned, the user must manually refresh the screen after the clean has completed in order to be able to select an additional drive to be cleaned.

4. Replace the cleaning cartridge, if needed.

- A cleaning cartridge must be replaced after 50 uses. To determine the number of cleaning uses remaining, click on the Web User Interface, **Monitor Library->Inventory** .
- Click on the **(+)** located under that magazine presentation to expand the detail of resident cartridges.
- Cleaning cartridges are labeled as CLNxxxLx. Observe the information displayed for the slots containing a cleaning cartridge. The number of Media Loads represent how many times the cleaning cartridge has been used. The number 50, minus that Media Load number represents the number of uses remaining.

## Chapter 5. Operations

The following table lists menu navigation shortcuts to activities that can be performed via the Operator Control Panel and/or the Web User Interface.

Before using the Operator Control Panel or the Web user Interface, please review the information in Chapter 3: **User Interfaces**.

Table 5-1. Menu navigation shortcuts

Information/ Activity	Menu Navigation Shortcuts			
	Operator Control Panel	For More Info	Web User Interface	For More Info
Accessor, number of cartridge moves	<b>Monitor → Library → Status → Cycles</b>	“Monitor: Library” on page 5-10	<b>Monitor Library → Library Status</b>	“Monitor Library: Library Status” on page 5-37
Auto Clean, enable	<b>Configure → Library Settings → Auto Clean</b>	“Configure: Library” on page 5-20	<b>Configure Library → General</b>	“Configure Library: General” on page 5-44
Cartridge, currently active/moving	<b>Monitor → Library → Status → Act. Cart</b>	“Monitor: Library” on page 5-10	<b>Monitor Library → Library Status</b>	“Monitor Library: Library Status” on page 5-37
Cartridge, determine encryption	Not available with this interface		<b>Monitor Library → Inventory</b>	“Monitor Library: Inventory” on page 5-40
Cartridge, Inventory	<b>Monitor → Inventory → Magazines</b>	“Monitor: Inventory” on page 5-14	<b>Manage Library → Perform Inventory</b>	“Manage Library: Perform Inventory” on page 5-43
Cartridge, Move	<b>Control → Move Cartridges</b>	“Control: Move Cartridges” on page 5-16	<b>Manage Library → Move Media</b>	“Manage Library: Move Media” on page 5-42
Cartridge currently in drive (n), Cartridge label and slot source	<b>Monitor → Inventory → Drive (n)</b>	“Monitor: Inventory” on page 5-14	<b>Monitor Library → Drive Status</b>	“Monitor Library: Drive Status” on page 5-38
Cartridge in drive (n), cartridge slot source	<b>Monitor → Drive → Status → Drive (n)</b>	“Monitor: Drive” on page 5-12	<b>Monitor Library → Drive Status</b>	“Monitor Library: Drive Status” on page 5-38
Configuration, save and restore*	<b>Configure → Save/Restore</b>	“Configure: Save/Restore” on page 5-27	<b>Configure Library → Save/Restore</b>	“Configure Library: Save/Restore Configuration” on page 5-56
	* <b>Note:</b> From this location, you can not only save and restore your library configuration, but you can also restore factory defaults.			
Control path, enable	<b>Configure → Drive → Control Path</b>	“Configure: Drive” on page 5-23	<b>Configure Library → Drives</b>	“Configure Library: Drives” on page 5-49

Table 5-1. Menu navigation shortcuts (continued)

Information/ Activity	Menu Navigation Shortcuts			
	Operator Control Panel	For More Info	Web User Interface	For More Info
Date and time, current setting	<b>Monitor → Library → Status → Date/Time</b>	“Monitor: Library” on page 5-10	Current date and time displayed in System Status screen.	“System Status” on page 2-6
Date and time, set	<b>Configure → Set Date and Time</b>	“Configure: Set Date and Time” on page 5-29	<b>Configure Library → Date &amp; Time</b>	“Configure Library: Date & Time” on page 5-54
Dedicated Cleaning slot, removing, reinstating	<b>Configure → Library Settings</b>	“Configure: Library” on page 5-20	Not available with this interface	
	<b>Note:</b> Dedicated Cleaning Slot (DCS) only available on earlier versions of the 4U library. Refer to “Inserting the Cleaning Cartridge” on page 4-37.			
DHCP, current status	<b>Monitor → Library → Network → DHCP</b>	“Configure: Network” on page 5-24	<b>Configure Library → Network</b>	“Configure Library: Network” on page 5-50
DHCP, modify	<b>Configure → Network → DHCP</b>	“Configure: Network” on page 5-24	<b>Configure Library → Network</b>	“Configure Library: Network” on page 5-50
Diagnostics, run drive Head test	<b>Service → Service → Drive Tests</b>	“Service: Run Tests” on page 5-31	Not available with this interface	
Diagnostics, run drive Media test	<b>Service → Service → Drive Tests</b>	“Service: Run Tests” on page 5-31	Not available with this interface	
Diagnostics, run drive Normal Read/Write test	<b>Service → Service → Drive Tests</b>	“Service: Run Tests” on page 5-31	Not available with this interface	
Diagnostics, run drive POST	<b>Service → Service → Drive Tests</b>	“Service: Run Tests” on page 5-31	Not available with this interface	
Diagnostics, run Key Path diagnostics (if feature is available)	Not available with this interface		<b>Service Library → Key Path Diagnostics</b>	“Service Library: Key Path Diagnostics” on page 5-61
Diagnostics, run Library Verify test	<b>Service → Library Verify</b>	“Service: Library Verify” on page 5-30	Not available with this interface.	
Diagnostics, run Slot to Slot test	<b>Service → Run Tests</b>	“Service: Run Tests” on page 5-31	<b>Service Library → Perform Diagnostics</b>	“Service Library: Perform Diagnostics” on page 5-60
Diagnostics, run System Test	<b>Service → Run Tests</b>	“Service: Run Tests” on page 5-31	<b>Service Library → Perform Diagnostics</b>	“Service Library: Perform Diagnostics” on page 5-60



Table 5-1. Menu navigation shortcuts (continued)

Information/ Activity	Menu Navigation Shortcuts			
	Operator Control Panel	For More Info	Web User Interface	For More Info
Display Contrast	<b>Service → Display Contrast</b>	“Service: Display Contrast” on page 5-32	Not available with this interface.	
DNS, modify settings	Not available with this interface.		<b>Configure Library → Network</b>	“Configure Library: Network” on page 5-50
Drive, change interface configuration	<b>Configure → Drive → Drive Interface</b>	“Configure: Drive” on page 5-23	<b>Configure Library → Drives</b>	“Configure Library: Drives” on page 5-49
Drive, change SCSI/Loop ID	<b>Configure → Drive → Drive Interface</b>	“Configure: Drive” on page 5-23	<b>Configure Library → Drives</b>	“Configure Library: Drives” on page 5-49
Drive, clean	<b>Service → Service → Clean Drive</b>	“Service: Service (Drives)” on page 5-31	<b>Service Library → Clean Drive</b>	“Service Library: Clean Drive” on page 5-57
Drive, current SCSI/Loop ID	<b>Monitor → Drive → Identity</b>	“Monitor: Drive” on page 5-12	<b>Monitor Library → Drive Identity</b>	“Monitor Library: Drive Identity” on page 5-35
Drive, current status	<b>Monitor → Drive → Status</b>	“Monitor: Drive” on page 5-12	<b>Monitor Library → Drive Status</b>	“Monitor Library: Drive Status” on page 5-38
Drive, data compression status	Not available with this interface.		<b>Monitor Library → Drive Identity → Data Compression</b>	“Monitor Library: Drive Identity” on page 5-35
Drive, Fibre, Worldwide Node Name	<b>Monitor → Drive → Identity → Drive (n)/WWNN</b>	“Monitor: Drive” on page 5-12	<b>Monitor Library → Drive Identity</b>	“Monitor Library: Drive Status” on page 5-38
Drive, Hashed SAS Address	Not available with this interface.		<b>Monitor Library → Drive Status</b>	“Monitor Library: Drive Status” on page 5-38
Drive, Interface type	<b>Configure → Drive → Drive Interface</b>	“Configure: Drive” on page 5-23	<b>Monitor Library → Drive Identity</b>	“Monitor Library: Drive Identity” on page 5-35
Drive, SCSI Inquiry string	<b>Monitor → Drive → Identity</b>	“Monitor: Drive” on page 5-12	<b>Monitor Library → Drive Identity</b>	“Monitor Library: Drive Identity” on page 5-35
Drive, turn power ON/OFF	<b>Service → Service → Drive Power</b>	“Service: Service (Drives)” on page 5-31	<b>Configure Library → Drive</b>	“Configure Library: Drives” on page 5-49
Drive activity, current	<b>Monitor → Drive → Status → Drive (n)/Activity</b>	“Monitor: Drive” on page 5-12	<b>Monitor Library → Drive Status</b>	“Monitor Library: Drive Status” on page 5-38
Drive fan, status	Not available with this interface		<b>Monitor Library → Drive Status</b>	“Monitor Library: Drive Status” on page 5-38

Table 5-1. Menu navigation shortcuts (continued)

Information/ Activity	Menu Navigation Shortcuts			
	Operator Control Panel	For More Info	Web User Interface	For More Info
Drive Dump, save	Not available with this interface.		<b>Service Library → Save Drive Dump</b>	“Service Library: Save Drive Dump” on page 5-60
Encryption, activate	Not available with this interface.		<b>Configure Library → Encryption</b>	“Configure Library: Encryption” on page 5-47
Encryption, configure	Not available with this interface.		<b>Configure Library → Encryption</b>	“Configure Library: Encryption” on page 5-47
Encryption, testing configuration (if feature is available)	Not available with this interface.		<b>Service Library → Key Path Diagnostics</b>	“Service Library: Key Path Diagnostics” on page 5-61
Encryption, determine method, current method	Not available with this interface.		<b>Monitor Library → Drive Status</b>	“Monitor Library: Drive Status” on page 5-38
Ethernet settings	<b>Monitor → Library → Network</b>	“Monitor: Library” on page 5-10	<b>Configure Library → Network</b>	“Configure Library: Network” on page 5-50
Email notifications: add, modify, and delete	Not available with this interface.		<b>Configure Library → Email Notification</b>	“Configure Library: Email Notification” on page 5-55
Error log, view	<b>Monitor → Library → Error log</b>	“Monitor: Library” on page 5-10	<b>Service Library → View logs</b>	“Service Library: View Logs” on page 5-58
Error logs and traces, set mode	Not available with this interface		<b>Configure Library → Logs &amp; Traces</b>	“Configure Library: Logs & Traces” on page 5-54
Factory Default settings, restore	<b>Configure → Save/Restore</b>	“Configure: Save/Restore” on page 5-27	<b>Configure Library → Save/Restore</b>	“Configure Library: Save/Restore Configuration” on page 5-56
Fibre Channel, speed	<b>Monitor → Drive → Status → Drive (n)</b>	“Monitor: Drive” on page 5-12	<b>Monitor Library → Drive Status</b>	“Monitor Library: Drive Status” on page 5-38
Fibre Channel speed, change	<b>Configure → Drives → Drive Interface</b>	“Configure: Drive” on page 5-23	<b>Configure Library → Drives</b>	“Configure Library: Drives” on page 5-49
Fibre Channel, topology	<b>Monitor → Drive → Status → Drive (n)</b>	“Monitor: Drive” on page 5-12	<b>Monitor Library → Drive Status</b>	“Monitor Library: Drive Status” on page 5-38

Table 5-1. Menu navigation shortcuts (continued)

Information/ Activity	Menu Navigation Shortcuts			
	Operator Control Panel	For More Info	Web User Interface	For More Info
Fibre Channel topology, change	<b>Configure → Drives → Drive Interface</b>	“Configure: Drive” on page 5-23	<b>Configure Library → Drives</b>	“Configure Library: Drives” on page 5-49
Fibre Channel link, status	<b>Monitor → Drive → Status → Drive (n)/Link</b>	“Monitor: Drive” on page 5-12	<b>Monitor Library → Drive Status</b>	“Monitor Library: Drive Status” on page 5-38
Firmware, drive, current level	<b>Monitor → Drive → Identity</b>	“Monitor: Drive” on page 5-12	<b>Monitor Library → Drive Identity</b>	“Monitor Library: Drive Identity” on page 5-35
Firmware, library, identify current level	<b>Monitor → Library → Identity</b>	“Monitor: Library” on page 5-10	<b>Monitor Library → Library Identity</b>	“Monitor Library: Library Identity” on page 5-34
Firmware, library or drive update	Not available with this interface.		<b>Service Library → Upgrade Firmware</b>	“Service Library: Upgrade Firmware” on page 5-62
Gateway, current address	<b>Monitor → Library → Network → Gateway</b>	“Monitor: Library” on page 5-10	<b>Configure Library → Network</b>	“Configure Library: Network” on page 5-50
Gateway Address, modify	<b>Configure → Network → Gateway</b>	“Configure: Network” on page 5-24	<b>Configure Library → Network</b>	“Configure Library: Network” on page 5-50
Inventory, perform	<b>Control → Re-Inventory</b>	“Control: Re-Inventory” on page 5-18	<b>Manage Library → Perform Inventory</b>	“Manage Library: Perform Inventory” on page 5-43
I/O Station, configuring	<b>Configure → Library Settings → I/O Station</b>	“Configure: Library” on page 5-20	<b>Configure Library → General</b>	“Configure Library: General” on page 5-44
I/O Station, current status	<b>Monitor → Library → Status</b>	“Monitor: Library” on page 5-10	<b>System Status screen</b>	
I/O Station, open	<b>Control → Open I/O Station</b>	“Control: Open I/O Station” on page 5-16	Not available with this interface	
IP Address, current	<b>Monitor → Library → Network</b>	“Monitor: Library” on page 5-10	<b>Monitor Library → Library Identity</b>	“Monitor Library: Library Identity” on page 5-34
IP Address, modify	<b>Configure → Network → IP Address</b>	“Configure: Network” on page 5-24	<b>Configure Library → Network</b>	“Configure Library: Network” on page 5-50
Library, current status	<b>Monitor → Library → Status</b>	“Monitor: Library” on page 5-10	<b>Monitor Library → Library Status</b>	“Monitor Library: Library Status” on page 5-37
Logical libraries, configure	<b>Configure → Logical Libraries</b>	“Configure: Logical Libraries” on page 5-18	<b>Configure Library → Logical Libraries</b>	“Configure Library: Logical Libraries” on page 5-45

Table 5-1. Menu navigation shortcuts (continued)

Information/ Activity	Menu Navigation Shortcuts			
	Operator Control Panel	For More Info	Web User Interface	For More Info
Logs, library, view	<b>Monitor → Library → Error Log</b>	“Monitor: Library” on page 5-10	<b>Service Library → View Logs</b>	“Service Library: View Logs” on page 5-58
Magazines, graphical representation	<b>Monitor → Inventory → Magazines</b>	“Monitor: Inventory” on page 5-14	<b>Monitor Library → Inventory</b>	“Monitor Library: Inventory” on page 5-40
Magazines, Unlock	<b>Control → Magazines</b>	“Control: Magazine” on page 5-17	<b>Manage Library → Release Magazine</b>	“Manage Library: Release Magazine” on page 5-43
Mode, library, change	<b>Configure → Library Settings → Mode</b>	“Configure: Library” on page 5-20	<b>Configure Library → General</b>	“Configure Library: General” on page 5-44
Mode, library, current	<b>Monitor → Library → Identity</b>	“Monitor: Library” on page 5-10	<b>Monitor Library → Library Identity</b>	“Monitor Library: Library Identity” on page 5-34
Netmask, current address	<b>Monitor → Library → Network</b>	“Monitor: Library” on page 5-10	<b>Configure Library → Network</b>	“Configure Library: Network” on page 5-50
Netmask Address, modify	<b>Configure → Network → Netmask</b>	“Configure: Network” on page 5-24	<b>Configure Library → Network</b>	“Configure Library: Network” on page 5-50
Network configuration, change	<b>Configure → Network</b>	“Configure: Network” on page 5-24	<b>Configure Library → Network</b>	“Configure Library: Network” on page 5-50
Network configuration, view	<b>Monitor → Library → Network</b>	“Monitor: Library” on page 5-10	<b>Configure Library → Network</b>	“Configure Library: Network” on page 5-50
Path Failover, enter activation key	<b>Configure → Control Path Failover</b>	“Configure: Path Failover” on page 5-29	<b>Configure Library → Path Failover</b>	“Configure Library: Path Failover” on page 5-46
Restart, library,	Not available with this interface.		<b>Service Library → Reboot</b>	“Service Library: Reboot” on page 5-63
SCSI Inquiry string, drive	<b>Monitor → Drive → Identity</b>	“Monitor: Drive” on page 5-12	<b>Monitor Library → Drive Identity</b>	“Monitor Library: Drive Identity” on page 5-35
Serial Number, drive	<b>Monitor → Drive → Identity</b>	“Monitor: Drive” on page 5-12	<b>Monitor Library → Drive Identity</b>	“Monitor Library: Drive Identity” on page 5-35
Serial Number, library	<b>Monitor → Library → Identity</b>	“Monitor: Library” on page 5-10	<b>Monitor Library → Library Identity</b>	“Monitor Library: Library Identity” on page 5-34
Slots, number active	<b>Monitor → Library → Identity</b>	“Monitor: Library” on page 5-10	<b>System Status screen</b>	

Table 5-1. Menu navigation shortcuts (continued)

Information/ Activity	Menu Navigation Shortcuts			
	Operator Control Panel	For More Info	Web User Interface	For More Info
Slots, number empty	<b>Monitor → Library → Status</b>	“Monitor: Library” on page 5-10	<b>System Status screen</b>	
Slots, reassign number of active, reserving	<b>Note:</b> Varies according to the number logical libraries.  Single partition: <b>Configure → Logical Library Settings</b>  Multiple partitions: <b>Configure → Logical Library Settings → Logical Library (n)</b>	“Configure: Library” on page 5-20	<b>Configure Library → General</b>	“Configure Library: General” on page 5-44
SNMP, modify settings	Not available with this interface.		<b>Configure Library → SNMP</b>	“Configure Library: SNMP” on page 5-56
Telnet Service Port, activate	<b>Service → Telnet Service Port</b>	“Service: Telnet Service Port” on page 5-33	Not available with this interface.	
Time elapsed since power ON	<b>Monitor → Library → Status</b>	“Monitor: Library” on page 5-10	<b>Monitor Library → Library Status</b>	“Monitor Library: Library Status” on page 5-37
Operator Control Panel, access PIN, enable/disable	<b>Configure → Set Access PIN</b>	“Configure: Set Access PIN” on page 5-25	Not available with this interface.	
Web User Interface, user access, create or modify	Not available with this interface.		<b>Configure Library → User Access</b>	“Configure Library: User Access” on page 5-52

## Operator Control Panel Navigation

The four control keys on the front of a 2U or 4U library enable the user to navigate through the library settings and make changes as needed to configure the library.

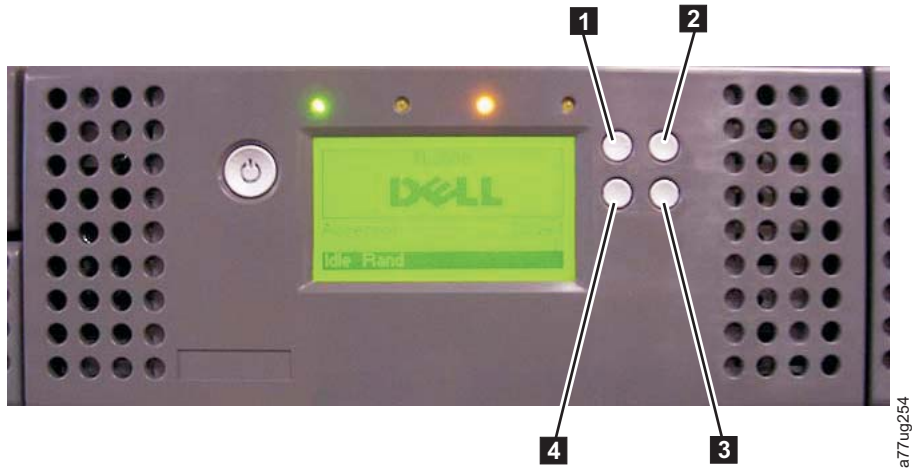

Figure 5-1. 2U Library Control Keys

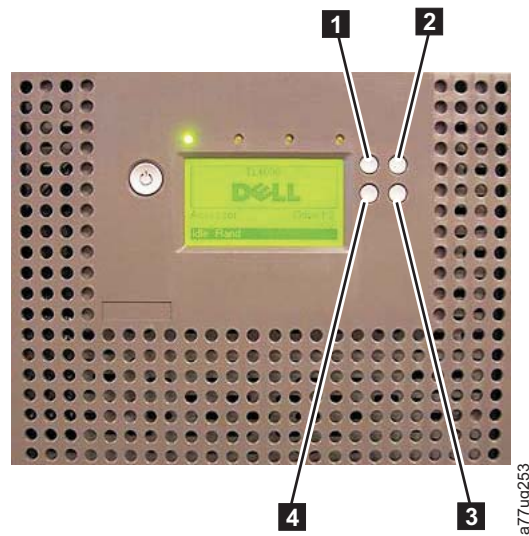

Figure 5-2. 4U Library Control Keys

Table 5-2. Library Control Keys

Control Keys	Description
<b>1</b>	<b>UP (Λ)</b> - Upper-left button Used to scroll upward through menu items.
<b>2</b>	<b>CANCEL (X)</b> - Upper-right button Used to cancel a user action and return to the previous menu screen.
<b>3</b>	<b>SELECT (v)</b> - Lower-right button Used to display a sub-menu or force an accessor action.
<b>4</b>	<b>DOWN (v)</b> - Lower-left button Used to scroll downward through menu items.

1. Press the UP ( **1** ) or DOWN( **4** ) keys to enter Interaction Mode. The Main Selection Menu will appear. The Main Selection screen shows Monitor, Control, Configure, and Service.
2. Scroll to your selection, then press the SELECT ( **3** ) key. The sub-menu for the selected menu item will appear.
3. Use the UP ( **1** ) or DOWN( **4** ) and SELECT ( **3** ) keys to scroll until you get to the area/screen you wish to configure.
4. Use the CANCEL ( **2** ) key if you wish to move backwards through the menu selections.

---

## Operator Control Panel Menu Tree

The Operator Control Panel Main menu is made up of the following items:

- Monitor
- Control
- Configure
- Service

The table below shows each Main menu item and the associated sub menu items.

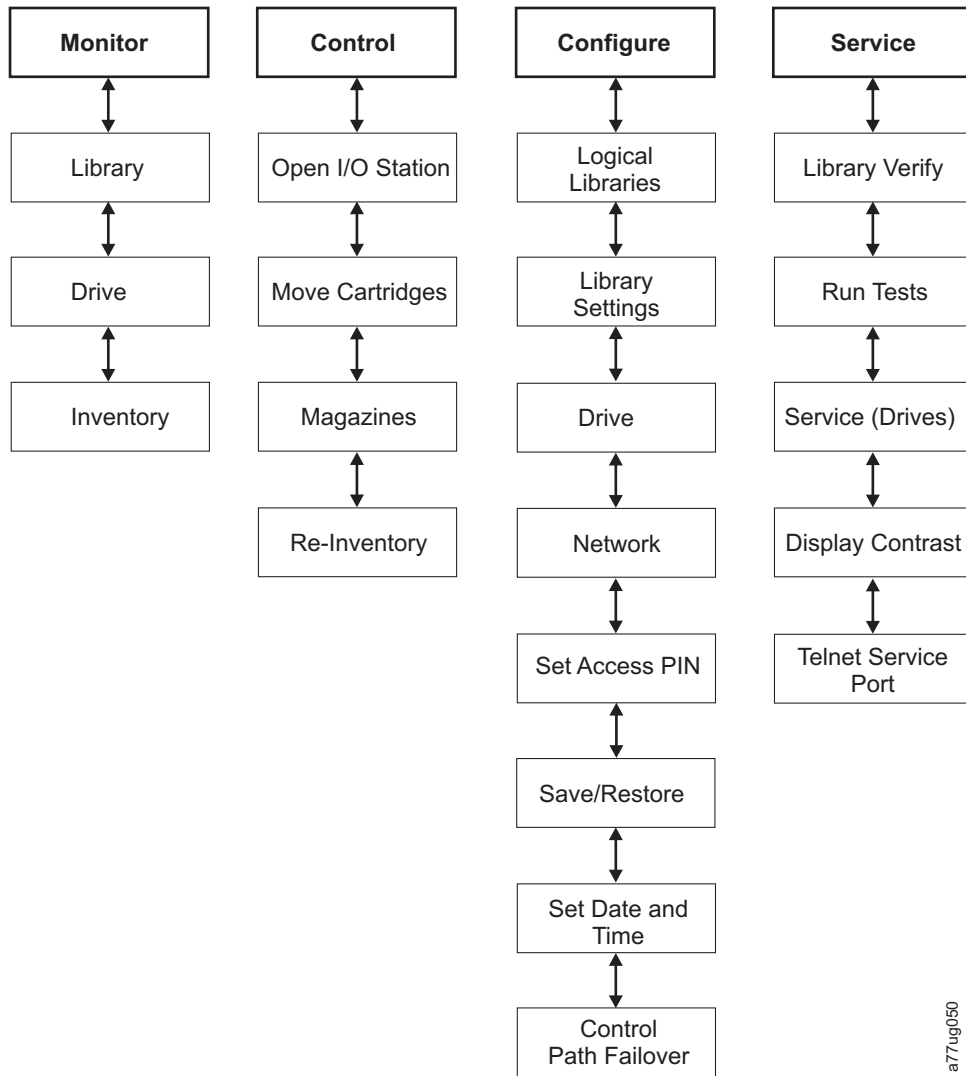

a77ug050

Figure 5-3. Operator Control Panel Menu Tree

**Note:** Depending on the version of library firmware, there may be differences between the Menu Tree description in this document and the OCP Menu Tree on your library.

## Monitor Menu

The Monitor menu contains information about the following sub menu items:

- Library
- Drive
- Inventory

### Monitor: Library

This menu item displays current library information and settings.



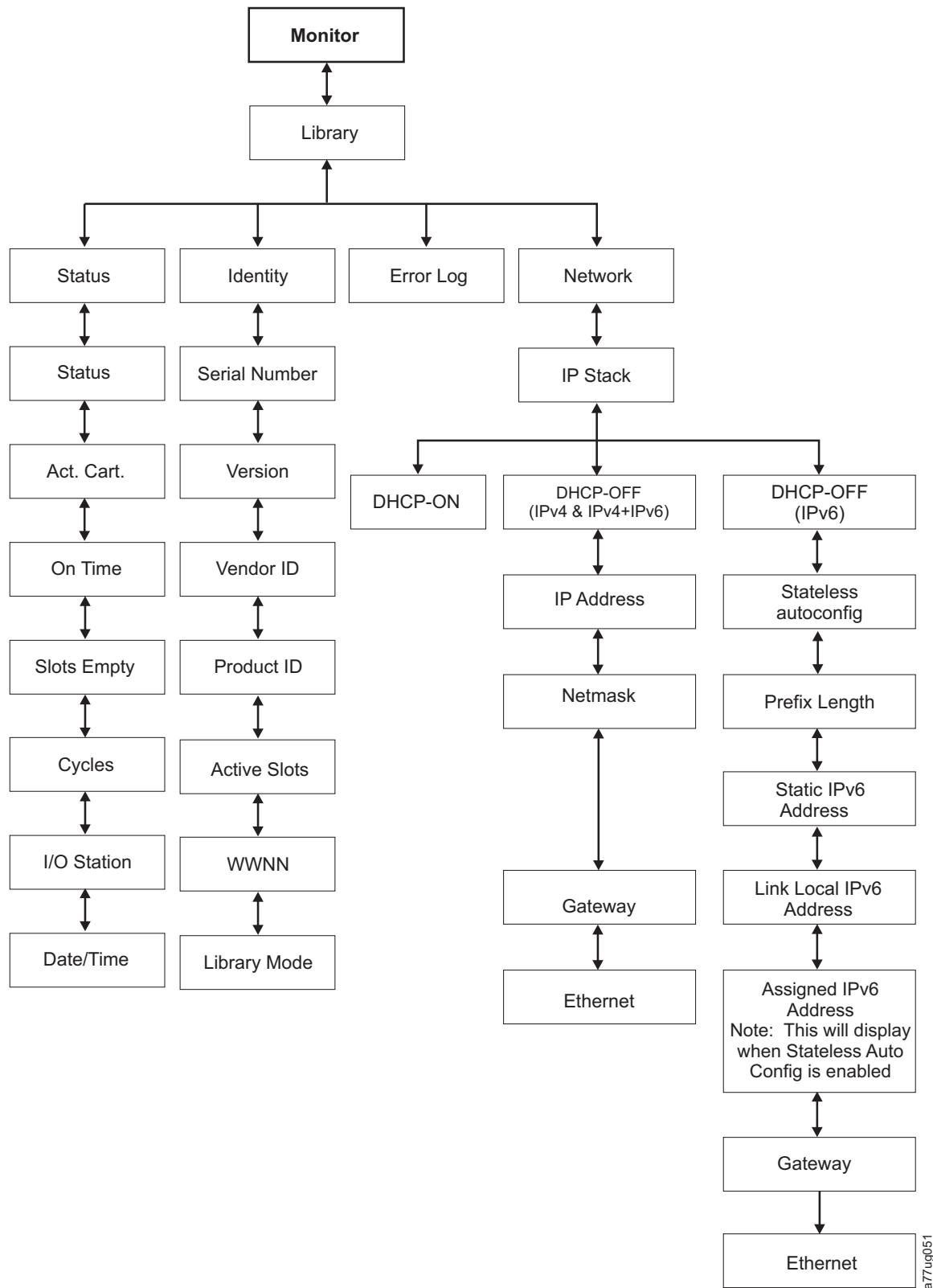

Figure 5-4. Monitor: Library menu

Under **Monitor** → **Library** are the following items:

- **Status**

- **Identity**
- **Error Log**
- **Network**

Under **Monitor** → **Library** → **Status** are the following items:

- Status - current status of the library
- Act. Cart - the serial number of the cartridge currently active in the library
- On Time - the amount of time the library has been powered ON
- Slots Empty - the number of empty slots in the library/total number of active slots in the library
- Cycles - the total number of cartridge moves carried out by the library accessor
- I/O Station - indicates whether the I/O Station is open or closed
- Date/Time - gives the current date and time set in the library

Under **Monitor** → **Library** → **Identity** are the following items:

- Service Tag - the service tag of the library
- Version - the current level of library firmware installed
- Vendor ID - Dell
- Product ID - TL2000/TL4000
- Active Slots - number of active slots in each logical library
- WWNN - World Wide Node Name of the library
- Library Mode - current library mode (Random or Sequential)

Under **Monitor** → **Library** → **Error Log**, you will have a list of errors logged by the library. The errors will be displayed beginning with the most recent error.

Under **Monitor** → **Library** → **Network** are the following items:

- IP Stack - the internet protocol currently being used by the library
- DHCP - (Dynamic Host Configuration Protocol) - records whether DHCP is ON or OFF
- IP Addresses - the internet addresses of the library
- Netmask - the Network Mask Address of the library
- Gateway - the Gateway Address of the library
- Ethernet - the speed of the ethernet interface
- Stateless auto configuration - indicates whether or not stateless auto configuration is enabled
- Prefix Length - the length of the IP Address prefix
- Static IPv6 Address - the static IPv6 address of the library
- Link Local IPv6 Address - local link-only IPv6 address of the library
- Router assigned IPv6 Address - IPv6 address(es) discovered by the network router

### **Monitor: Drive**

This menu item displays drive information and settings.

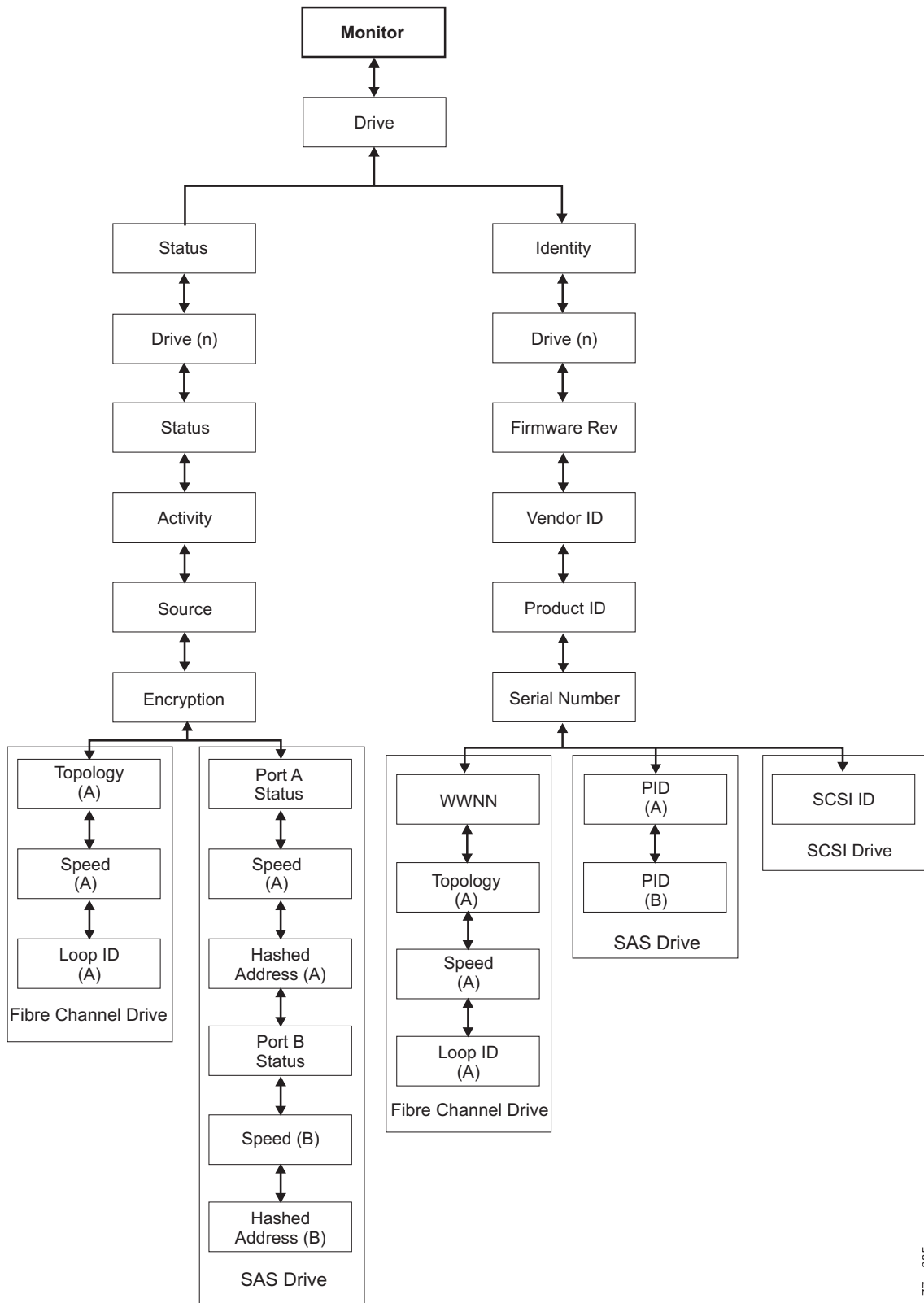

a77ug035

Figure 5-5. Monitor: Drive menu

- Under **Status** and **Drive (n)** are the following items:
- Status - the current status of the drive

- Activity - the current action being performed by the drive
- Source - the serial number of the cartridge currently in the drive
- Encryption - indicates the type of data encryption currently set for the selected drive
- Topology - the topology chosen for a fibre library (see "Fibre Channel Interface" on page 3-9)
- Speed - indicates the speed of the fibre channel (fibre library)
- Link - indicates the status of the fibre channel (fibre library)
- Hashed Address - an address calculated from the WWID

Under **Identity** and **Drive (n)** are the following items:

- Firmware Rev - the current level of drive firmware
- Vendor ID - Dell
- Product ID - drive inquiry string
- Serial Number - the drive serial number
- SCSI ID - the unique identifier assigned to a SCSI drive
- WWNN - the fibre channel drive's World Wide Node Name
- Topology - the topology chosen for the fibre channel drive
- Speed - indicates the speed of the fibre channel tape drive
- Loop ID - unique identifier assigned to a fibre channel tape drive
- PID - port identification (SAS only)

### **Monitor: Inventory**

This menu item displays the current library inventory of a 4U library.

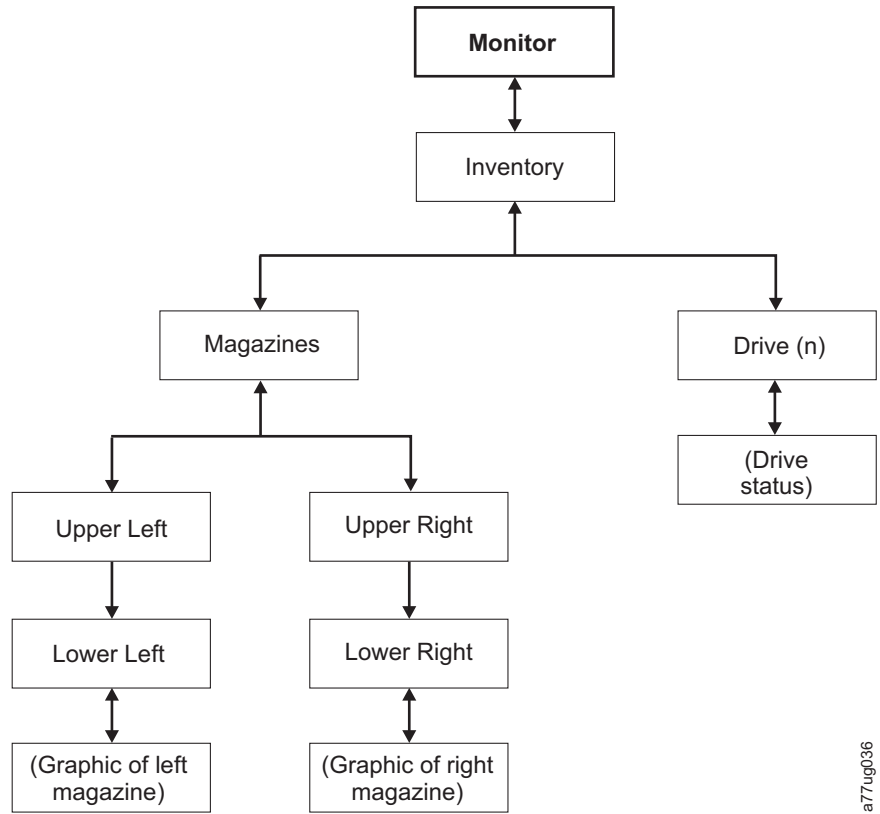

Figure 5-6. Example of a 4U Monitor: Inventory menu

**Note:** 2U has a single right side magazine.

Under **Magazine** choose one of the following to see a graphical representation of the cartridge magazine(s). Slots containing cartridges will be highlighted.

Magazines > Lower Left			
I/O 3	7	8	9
I/O 2	4	5	6
I/O 1	1	2	3
Idle Rand			

Figure 5-7. Overview of inventoried cartridges: Lower Left Magazine of a 4U Library

**Note:** Left magazine of a 2U Library has a 1-slot I/O Station

The black boxes are inventoried cartridges. Press the up and down keys to scroll. Note that this magazine has a 3-slot I/O Station. These slots can be changed to storage slots if needed. See “Configuring I/O Stations and Reserving Slots” on page 5-65.

Press **SELECT** to display all empty slots and cartridge serial numbers in the associated magazine.

Magazines > Lower Left	
2	DT0632L4 LTO4 EC
3	3FB114L4 LTO4 ED
4	Empty
5	Empty
Idle Rand	

Figure 5-8. Detailed information on cartridges residing in a magazine

Table 5-3. Detailed information on cartridges residing in a magazine

<b>1</b>	Magazine slot number	<b>3</b>	Media type (generation of cartridge)
<b>2</b>	Cartridge volume serial number or “Empty” (meaning no cartridge currently residing in slot)	<b>4</b>	Encryption abbreviation for LTO4 cartridges: <ul style="list-style-type: none"> <li>• EC - encryption capable (The LTO 4 cartridge does not contain encrypted data).</li> <li>• ED- encrypted data (The LTO 4 cartridge does contain encrypted data).</li> </ul>

## Control Menu

The Control Menu contains the following items:

- Open I/O Station
- Move Cartridges
- Magazine
- Re-Inventory

### Control: Open I/O Station

Use this menu item to open the I/O Station.

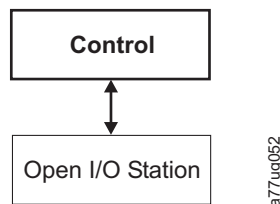

Figure 5-9. Control: I/O Station menu

**Attention:** After closing the I/O Station, you must wait for the library to complete its inventory before proceeding with normal library operations.

### Control: Move Cartridges

Use this menu item to move cartridges in the library.

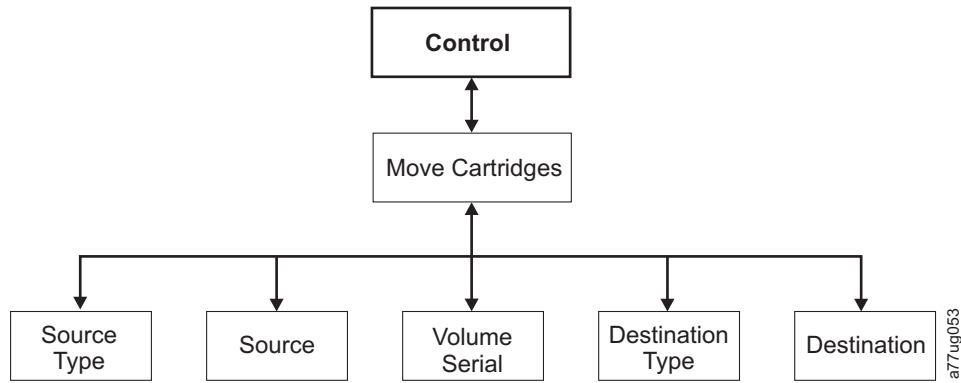

Figure 5-10. Control: Move Cartridges menu

To move a cartridge from point A to point B, you must make the following choices:

- Source Type - Drive, I/O station, magazine. Only the source type(s) that contain cartridges will be listed.
- Source - the choices start with the choice made in the preceding item and then advances through all available choices.

**Note:** If the Attention LED is ON due to a suspect cartridge, that cartridge will be identified by an exclamation point (!) when scrolling through the source cartridges.

- Volume Serial - the serial number of the cartridge
- Dest Type - the destination Drive, I/O station, magazine
- Dest - the choices start with the choice made in the preceding item and then advances through all available choices.

### Control: Magazine

Use this menu item to unlock the cartridge magazines.

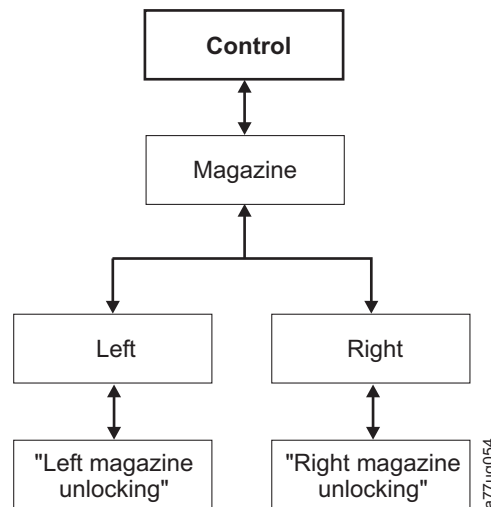

Figure 5-11. Control: Magazine menu

Choose "Left" or "Right" to unlock the corresponding cartridge magazine(s). The magazines can now be removed from the library by gently pulling each magazine

out of the library. To replace a magazine, insert the back of the magazine into the front of the library and gently push the magazine into the library. The magazine will lock when inserted into the library.

**Attention:** After inserting the magazines into the library, you must wait for the library to complete its inventory before proceeding with normal library operations.

If the magazines are not pulled out of the library within 15 seconds after they are unlocked, the command will cancel and you will have to repeat the process to unlock the magazines.

### **Control: Re-Inventory**

Use this menu item to initiate a scan of the cartridges currently in the library.

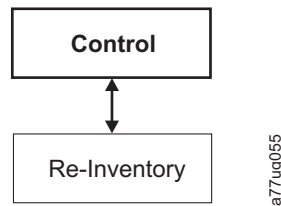

Figure 5-12. Control: Re-Inventory menu

**Note:** It may take up to five minutes to complete the library inventory.

## **Configure Menu**

The Configure Menu is used during the initial setup of your library and when changes need to be made to your library's configuration. This menu contains the following items:

- Logical Libraries
- Library Settings
- Drive
- Network
- Set Access PIN
- Save/Restore
- Set Date and Time

### **Configure: Logical Libraries**

Use this menu item to select the number of logical libraries. The **Currently Configured - x** section shows the number of logical libraries currently configured.



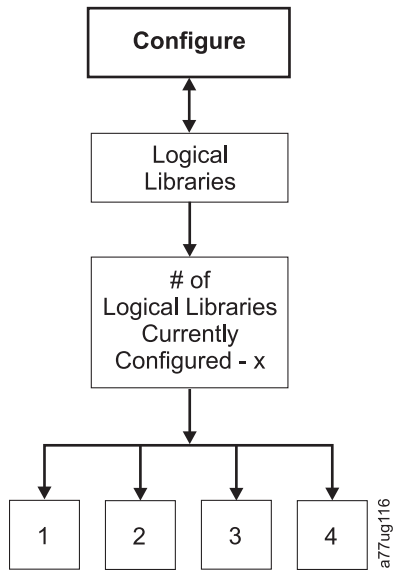

Figure 5-13. Configure: Logical Libraries menu

**Note:** The maximum number of Logical Libraries in a 2U is two.

**Note:** This menu is only available on libraries with multiple drives.

**Note:** Whenever there is a hardware configuration change such as drives being swapped with different form factors (i.e. HH to FH or FH to HH), a library configuration change is needed. Reconfiguring the library by reassigning the amount of logical libraries will clear this issue.

## Configure: Library

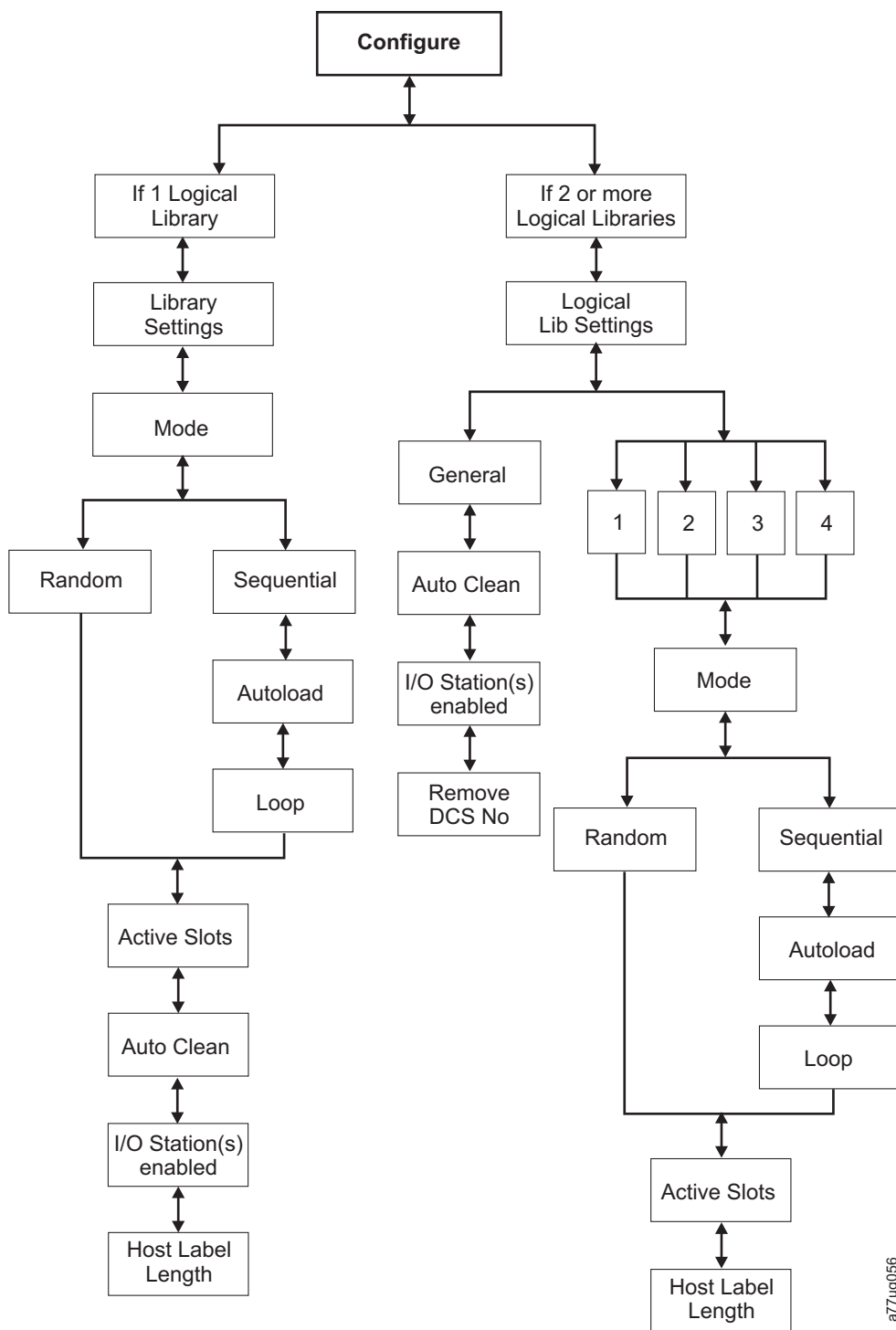

Figure 5-14. Configure: Library menu

**Note:** The Remove DCS No is only available on libraries with the DCS feature.

The following library configuration items are in this menu:

- **Mode:**

- **Random:** In random mode, the library allows the server's (host's) application software to select any data cartridge in any order.
- **Sequential:** In sequential mode, the library's firmware predefines the selection of the cartridges. After initialization, the firmware causes the library to select the first available cartridge found (counting from the I/O Station through slot 23) for loading into the drive.

**Important:** If a Logical Library in Sequential Mode contains more than one drive, only the first drive in the Logical Library will be utilized.

- **Autoload:** Sequential mode with autoload mode ON loads the first available cartridge (slot with the lowest numerical value that contains a cartridge) automatically if the library powers ON with an empty drive.
- **Loop:** Sequential mode with loop mode ON loads the cartridge in the lowest numerical slot after the cartridge in the highest numerical slot has been filled and sent back to its home slot. This allows endless backup operations without user interaction.
- **Starting Sequential Mode**
  - Autoload Option:
    - If the Autoload option is set to **ON (Configure → Library Settings → Autoload)**, the accessor will load the first cartridge (cartridge located in the slot with the lowest numeric value) found in the storage inventory area into the drive upon power ON of the library. If the library powers on with a cartridge already in the drive, sequential mode will start with that cartridge unless the host issues a rewind and unload command to the drive. In that case, the next cartridge in sequence will be loaded into the drive.
    - If the Autoload Option is **OFF**, sequential mode must be started by selecting the Move Cartridges option (**Control → Move Cartridges**) to load the first cartridge (or any cartridge) into the drive. Whatever cartridge is loaded into the drive, that is where the sequence starts from. For example, if a cartridge from the fifth lowest numeric storage slot containing a cartridge is loaded using the Move Cartridges option, after the host issues a rewind/unload command, the next cartridge loaded will be the cartridge from the next higher numeric slot. Cartridges need not be in contiguous slots.
  - Loop Option:
    - If the Loop option is set to **ON (Configure → Library Settings → Loop)**, when the last cartridge (cartridge in the highest numeric slot) is unloaded and placed back into storage, the accessor will immediately start over again loading the first cartridge into the drive.
  - **Stopping Sequential Mode:** To stop sequential mode, use the Move Cartridges option from the Control menu (**Control → Move Cartridges**) to unload the drive. The next sequential cartridge will NOT be loaded. To restart sequential mode, use the same Control menu command to load a cartridge. The loading sequence will resume from that numeric slot in the cartridge inventory.
- **Active Slots** - the number of active slots in each logical library.

**Note:** Slots can be reserved so that they are invisible to the host. It may be necessary to set the number of **Active Slots** to match the number of slots that are available to the ISV software. Reserved slots are created by reducing the number of active slots.

- **Auto Clean** - Use this menu item to enable the Auto Clean function. All cleaning cartridges must have "CLNxxxLx" as part of the bar code.

With Auto Clean disabled, the cleaning tape can be stored in any data slot if you wish to manually clean the drives. This is not recommended.

With Auto Clean disabled, the cleaning tape can be stored in any data slot if it was put there under Backup Application control. In other words, the Backup Application is controlling the cleaning of the tape drives and the cleaning tape would be imported into this library under its control.

**Note:** The universal cleaning cartridge has a bar code CLNUxxLx. This cleaning cartridge is used to clean all LTO generation tape drives.

For Auto Clean to function, the following criteria must be met:

- On 4U libraries with library firmware of .80 or lower that still contain a Dedicated Cleaning Slot (DCS), or 4U libraries with library firmware higher than 1.95 that chose to retain the DCS in their library, a CLN cartridge must be present in that slot.
- On libraries that don't have a DCS, a storage slot must be reserved (RSVD) by reducing the active slot count by one.
- A cleaning cartridge (CLNxxxLx) must be placed or moved to the reserved slot.
- Auto Clean must be enabled.

**Note:** Cleaning cartridges must be replaced after 50 cleanings. The Web User Interface inventory screen will show the number of times the media has been loaded, not the number of cleaning sessions remaining. Subtract this number from 50 to determine the number of cleanings remaining.

- **I/O Station(s) enabled** - The I/O Station(s) can be enabled (the default), or disabled so the stations can be utilized as storage slots.
- **Remove DCS** - If the DCS has been removed, it cannot be reinstated. This option will no longer appear in the Operator Control Panel.
- **Host Label Length** - The Host Label Length is related to the Bar Code Labels appearing on the media being used. The default value is 8, but 6 can also be chosen.

## Configure: Drive

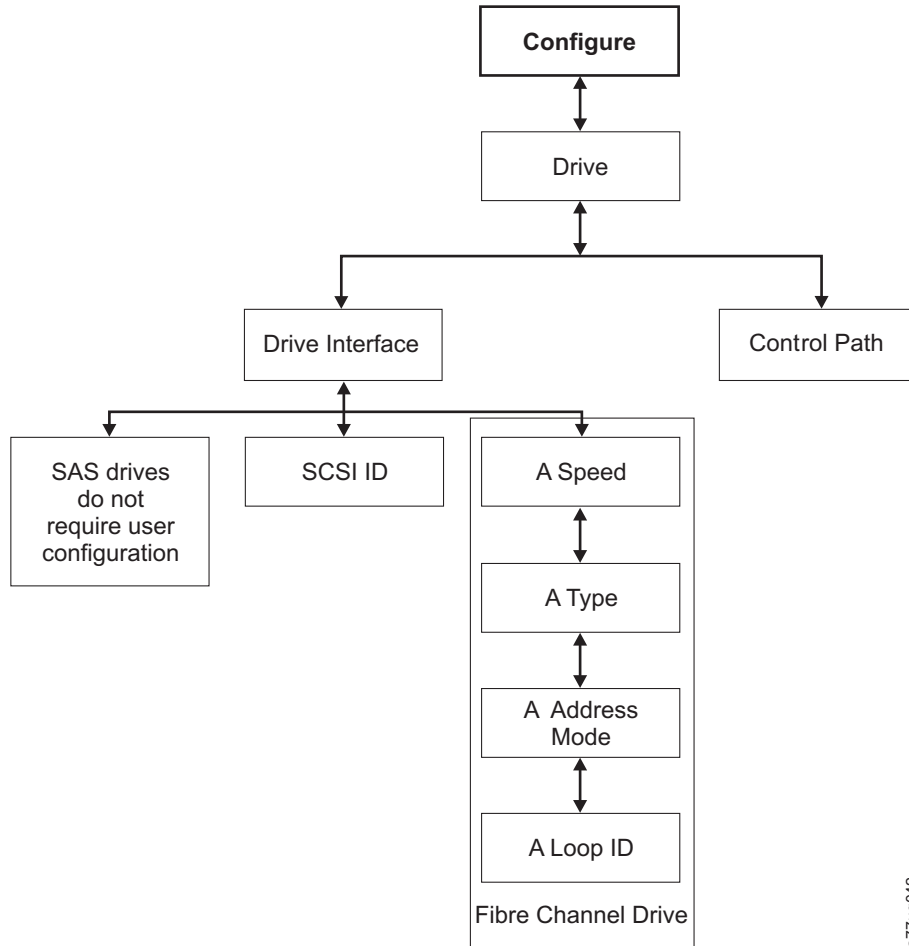

at7ug042

Figure 5-15. Configure: Drive menu

The following items are in this menu:

- **Drive Interface** - use this to assign a SCSI ID to a SCSI drive or to assign a Port Speed, Port Type, and Loop ID to a Fibre Channel drive. SAS drives do not require user configuration. For more information on drive interfaces, refer to “Host Interfaces” on page 3-7.
- **Control Paths** - use this to enable the drive as a control path drive. Each logical library must have a control path drive; however, all drives in a logical library can be designated as control path drives.

## Configure: Network

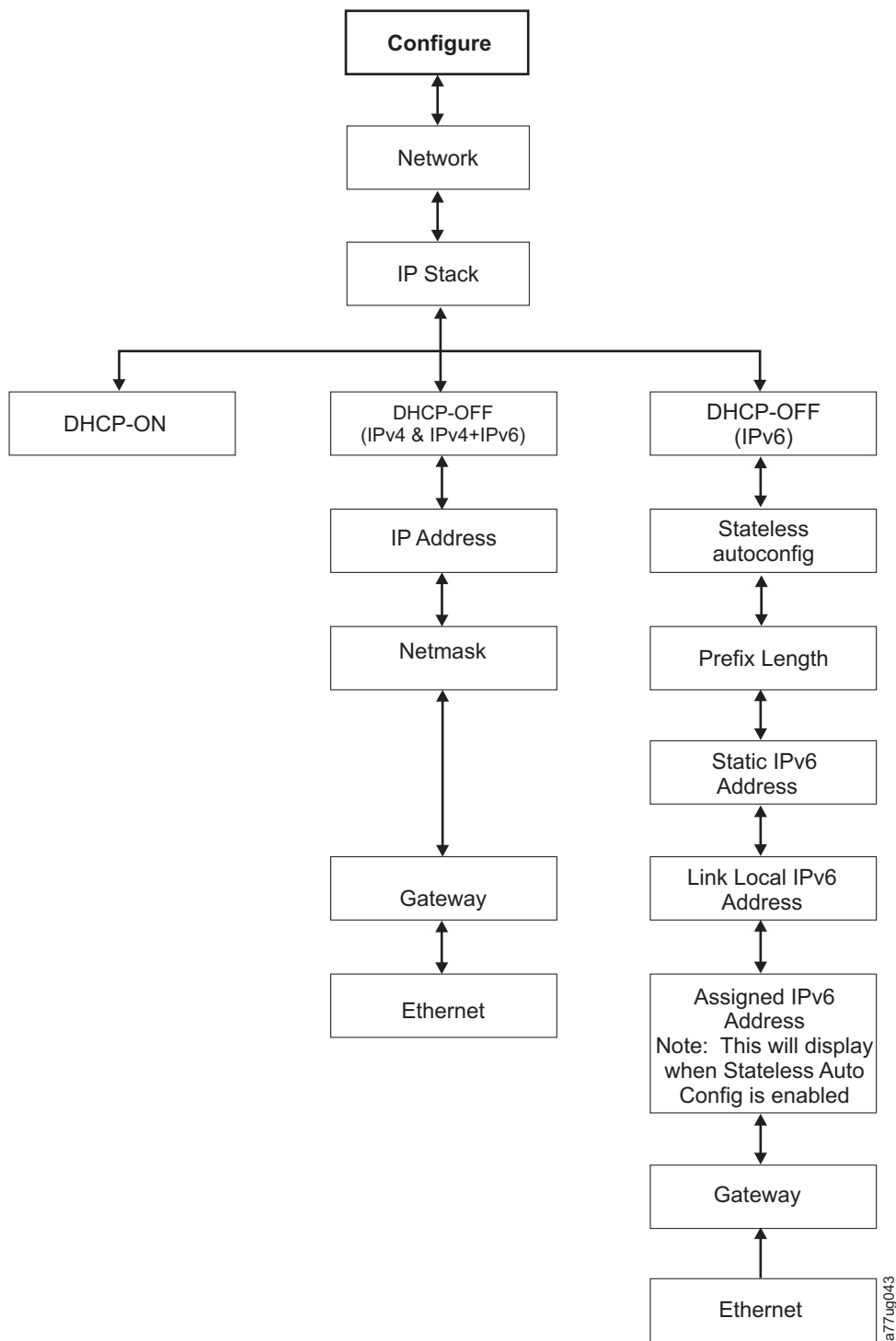

Figure 5-16. Configure: Network menu

Use these menu items to change the current network settings which allow you to access the library remotely via a web browser.

- **IP Stack** - Choose **IPv4 only**, **IPv6 only**, or **IPv4 & IPv6**.
- **IPv6 Only** and **Dual Stack IPv4 & IPv6** - Choose **Enable** Stateless Auto Config Address (Web User Interface) or Stateless Autoconfig (Operator Control Panel) if

assigned IPv6 IP addresses are desired. To view the assigned IPv6 addresses after enabling Stateless Auto Config Address, do the following:

– **Operator Control Panel (IPv6 Only): Monitor → Library → Network**

If you choose **Dual Stack IPv4 & IPv6**, you must be prepared to enter both IPv4 and IPv6 IP addresses.

- **DHCP** - (Dynamic Host Configuration Protocol) If this is enabled, your library host will negotiate the connection with the library. If DHCP is disabled, the following information is necessary to establish the remote access.
- **IP Address** - the IP address of the library
- **Netmask** - the Network Mask address of the library
- **IP Stack** - the IP Stack manages static IP addresses
- **Stateless autoconfig** - allows IPv6 hosts to be configured automatically when connected to a routed IPv6 network
- **Prefix length** - the length of the IP address prefix
- **Static IPv6 address** - a static IPv6 address that has been assigned to the library
- **Link Local IPv6 address** - an IPv6 address having link-only scope that can be used to reach neighboring nodes attached to the same link
- **Assigned IPv6 address** - an IPv6 address assigned by a router
- **Gateway** - the Gateway address of the library
- **Ethernet** - the current speed setting of the ethernet interface
- **DNS Server 1** - the first DNS server address
- **DNS Server 2** - the second DNS server address

**Note:** If a host and domain name are entered instead of an address, the IPv4 or IPv6 address will be resolved from the DNS using that name. That address will be stored in the library rather than the name. Therefore, if the address changes, the name or a new address will have to be entered.

### **Configure: Set Access PIN**

Use this menu item to enable/disable, set or change the Access PIN (personal identification number) which is used to restrict access to the Control, Configure, and Service menus.

**Note:** Record the Access PIN and store this in a secure location for future reference. Library configuration files, saved with the Save Library Config menu, do not include the Access PIN.

The Operator Control Panel (OCP) pin is turned off by default, but it is strongly recommended to be enabled if your environment requires unit security. Enabling the OCP pin feature prevents the unit settings from being tampered with. Users will be allowed to review the library status and manipulate media without entering the OCP pin.

If a unit administrator needs to make a configuration change in the unit, the OCP will ask for the 4-digit code in order to allow access to make changes. Once all the changes are completed the pin access will expire after 5 minutes of inactivity in the OCP (there is no log-out function in the library for this feature). A library reboot is recommended after making configuration changes to the library.

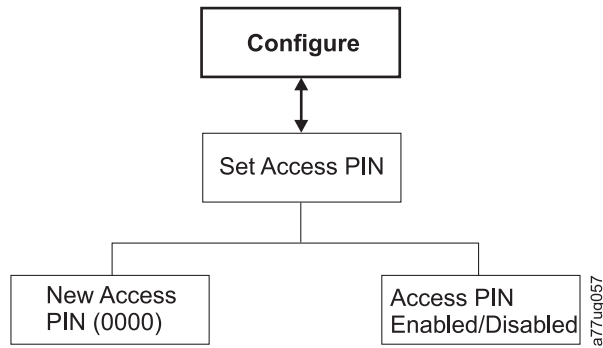

Figure 5-17. Configure: Set Access PIN menu

**Setting the Operator Control Panel Access PIN using the Operator Control Panel:**

1. Navigate to **Configure** → **Set Access PIN**.
2. Press the SELECT button to highlight the first digit of the 4-digit Access PIN.
3. Use the UP and DOWN buttons to select each digit.
4. Press the SELECT button to move to the next digit.
5. Repeat these steps for repeating the Access PIN.
6. After entering the final digit, press the DOWN button and select one of the following:
  - **Save** - to apply your settings.
  - **Cancel** - to delete your settings.

**Note:** In Figure 5-18 on page 5-27, menus with the pound sign (#) are the only menus accessible when the Access PIN is enabled, but entered incorrectly or before it is entered. To gain access to all menus, disable the Access PIN or enter the correct PIN number when requested.



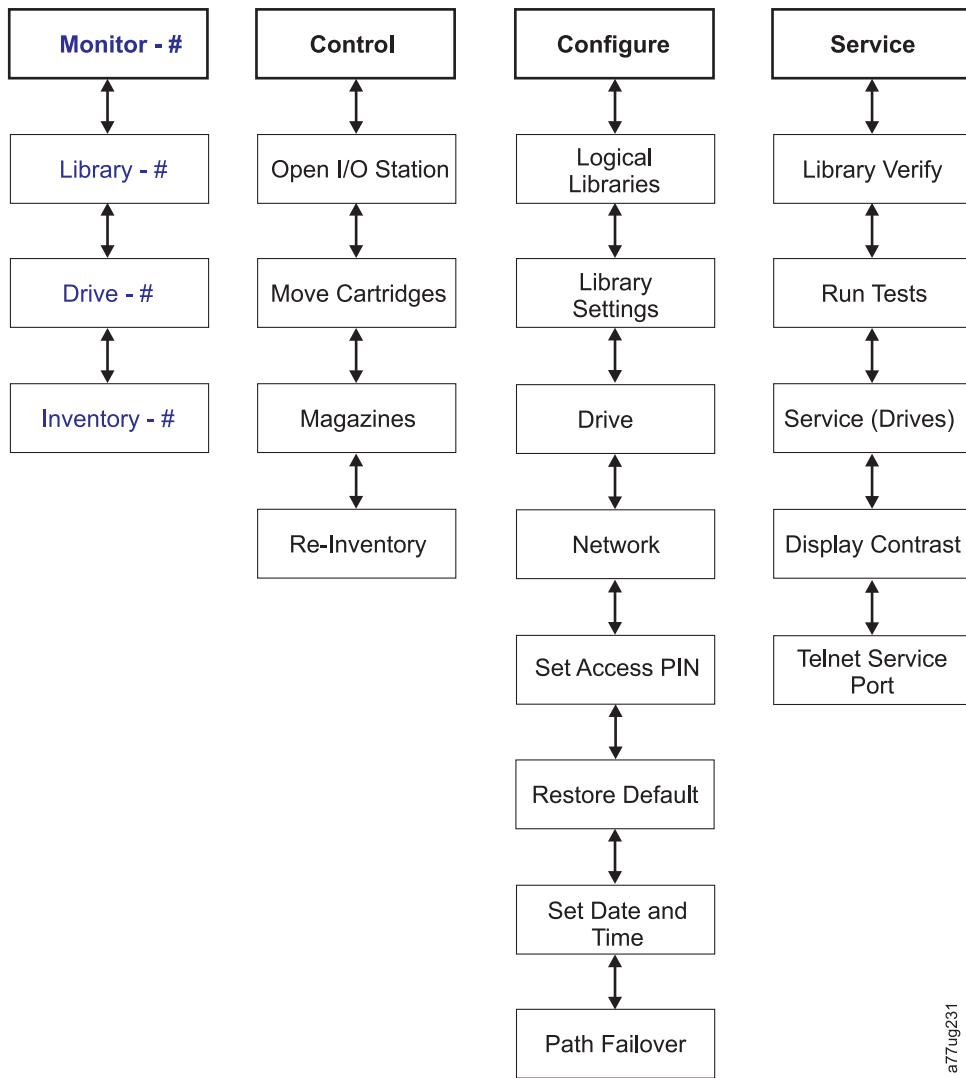

a77ug231

Figure 5-18. Pound sign (#) shows accessible menus when access PIN is enabled but before it is entered

### Configure: Save/Restore

Use this menu item to restore the factory default settings.

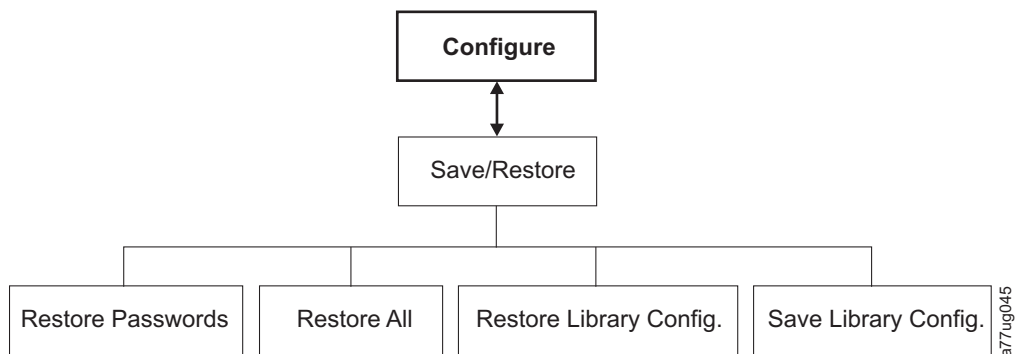

a77ug045

Figure 5-19. Configure: Save/Restore menu

- **Restore Passwords** - This menu item restores the factory default RMU Admin user access password.
- **Restore all** - This menu item restores all factory default settings (refer to Table 5-4).
- **Restore Library Config** - This menu item restores your saved library configuration from a USB device. If you have more than one saved configuration file (.dbb) on your USB device, press **Select**, then use the up and down keys to move between the different files. When the correct configuration file is displayed, press **Select** again.
- **Save Library Config** - This menu item saves your library configuration to a USB device.

**Note:** Ensure the USB device is formatted for FAT12, FAT16, or FAT32 and does not use autorun files.

**Note:** Configuration files saved with one version of library firmware may not be compatible with other versions of firmware. It is recommended to save a configuration file each time the library firmware is upgraded. Restore the library using a configuration file that was saved with the same version of firmware currently installed in the library.

**Important:** Restoring factory defaults will wipe out all the previous configuration data. Factory defaults must be restored when the library drive is changed from a LTO half height to full height configuration, in order for the library to correct the element addressing and drive numbering. If a new drive is added to the library configuration, a restore factory default is not required.

Table 5-4. Factory Default Settings

Restored Item	Default Setting*	Comments
Autoclean	Disabled	
Logical Libraries	1	
Active Slots	Maximum number of slots in library minus I/O Station	
I/O Station	Enabled	2U library has 1-slot I/O Station.4U library has 3-slot I/O Station.
Encryption	None	License Key is protected, if previously entered.
Ethernet Setting	Auto	
DHCP	Enabled	<b>Note:</b> DNS server addresses, if available, will be automatically assigned. If the DHCP server does not find any DNS server, the DNS fields will be set to "0.0.0.0".
Network IP Mode	IPv4 Only	
Bar Code Label Length Reported to Host	8	
SNMP	Disabled	
Email Notifications	None	
<b>User Access</b>		Restore from Operator Control Panel or Web User Interface
Admin	secure	(default)

Table 5-4. Factory Default Settings (continued)

Restored Item	Default Setting*	Comments
Library Mode	Random	
Library Name	(Blank)	
Host Name		(Depends on MAC Address)
Logs & Traces Error Log Mode	Continuous	
Path Failover Key	No change	License Key is protected, if previously entered.
OCP Access PIN	Disabled <b>Note:</b> The initial Factory Default setting is disabled. If the OCP Access PIN setting is changed, executing "Restore Defaults" will not change the setting.	If OCP Access PIN has been enabled the default PIN is "1234".
SSL for Web	Disabled	
<b>Drives</b>		
Power	Power On	(All drives)
Drive 1 SCSI-ID	4	SCSI Drives
Drive 2 SCSI-ID	5	SCSI Drives
Drive 3 SCSI-ID	6	SCSI Drives
Drive 4 SCSI-ID	8	SCSI Drives
Drive 1 Loop-ID	4	FC Drives Arbitrated Loop
Drive 2 Loop-ID	5	FC Drives Arbitrated Loop
Control Path Drive	Drive 1 only	
Partitions	None	
Reserved Slots	2U:24, 4U:48	
IPv6 Stateless Autoconfig	Enabled	
<b>Note:</b> * = all settings at library firmware level 4.xx and greater		

In some cases, (such as Library Mode), the entry of one option precludes any other options from being selected. In such cases, the details of the non-applicable options are not shown.

### Configure: Set Date and Time

Use this menu item to set the current date and time in your library.

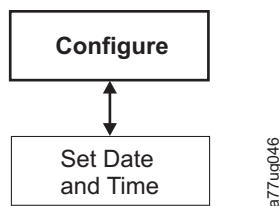

Figure 5-20. Configure: Set Date and Time menu

### Configure: Path Failover

Use this menu item to enter the Path Failover Feature Activation key (Supported on 4U library only for library firmware levels at or below 8.xx. Supported on both

the 2U and 4U libraries with library firmware levels above 8.xx).

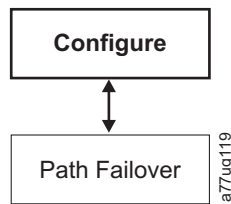

Figure 5-21. Configure: Path Failover

For library firmware levels below 8.xx the Path Failover feature is available for select LTO 4 tape drives, and Path Failover is not supported for Half Height drives. Library firmware levels higher than 8.xx support Path Failover on LTO 5 drives, as well as LTO 4 Full Height drives. For more information, refer to the *Dell PowerVault TL4000 Failover Configuration Guide*, included with the library documentation.

## Service Menu

The 2U/4U library is always online, except for when the user enters the Service Library area. A warning message appears stating that the library should be taken offline from the host before performing any Service functions. It is up to the operator to ensure that it is taken offline by phoning the host operator or other means of communication. Before performing any service functions, ensure the host is not performing any data writing or retrieval.

The **Service Menu** contains the following items:

- Library Verify - an overall library diagnostic
- Run Tests - other library diagnostics
- Service - diagnostics and procedures for servicing the drive
- Display Contrast - setting the display from light to dark
- Telnet Service Port

### Service: Library Verify

This is an overall diagnostic that exercises all library components. To run the Library Verify test, complete the following procedure.

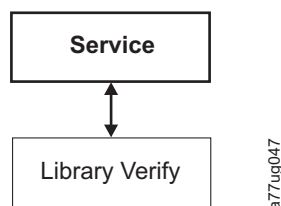

Figure 5-22. Service: Library Verify menu

1. On the Operator Control Panel, navigate to **Service** → **Library Verify** and start diagnostic.
  - Push the **Select** key to highlight the drive field. Use the **Up/Down** keys to select the drive. Push the **Select** key to complete the selection.
  - Push the **Down** key to highlight <Run>.
  - Push the **Select** key to execute Library Verify.

2. When prompted by the Operator Control Panel display and the I/O Station opens, insert a blank or scratch data cartridge.
3. Close the I/O Station by pushing it back into the library.
4. While the test is running, the Operator Control Panel will display library status.
  - If the test PASSES, resume normal library operations.
  - If the test FAILS, an error code will be displayed. Make note of the error, then refer to Chapter 7, "Troubleshooting," on page 7-1.

**Note:** Library Verify requires a piece of scratch media to perform the test. Once the test has been initiated, the user must complete the test.

5. When prompted by the Operator Control Panel display and the I/O Station opens, remove the cartridge used in the test.
6. Close the I/O Station by pushing it back into the library.
7. Use the **Up/Down** keys to highlight <Cancel>. Press the **Select** key to exit the Library Verify screen.

### Service: Run Tests

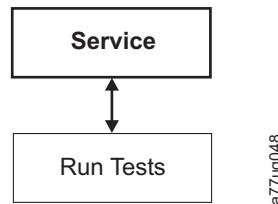

Figure 5-23. Service: Run Tests menu

The following library diagnostics are available in this menu:

- **System Test** - this test exercises library components by moving customer data cartridges from slots to drives and back to slots. No data is written or read from the customer tapes. To run this test successfully, the library must contain at least one data cartridge for every drive present in the library.
- **Slot to Slot Test** - The Slot To Slot test will move each resident data cartridge from one slot to another, for each test cycle requested. When completing the Slot To Slot test, you will need to **Inventory** your library before placing it back online, since this test scrambles the cartridge slot locations.

**Note:** After running the System Test or the Slot to Slot Test, the library will need to be re-inventoried. It might be required to reboot the library after library diagnostics completes to ensure proper library re-detection on some backup applications.

### Service: Service (Drives)

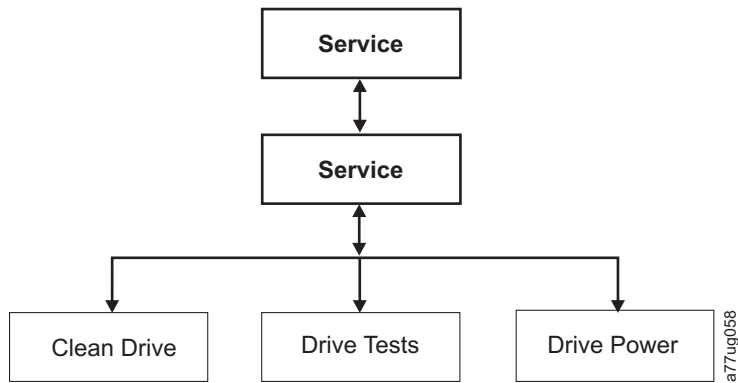

Figure 5-24. Service: Service menu

The following drive diagnostics and service procedures are available in this menu:

- **Clean Drive** - The accessor takes the cleaning cartridge from the dedicated cleaning cartridge slot (DCS), or previously reserved slot if no DCS is available, and inserts it into the drive. After the cleaning is complete, the accessor removes the cleaning cartridge from the drive and returns it to the dedicated cleaning cartridge slot or reserved slot.
- **Drive Tests** - Power On Self Test (POST), Normal Read/Write Test, Head Test, Media Test
  1. Navigate to the desired test (**Service** → **Service** → **Drive Tests**). Choose the drive if more than one is installed.
  2. Follow the instructions displayed on the Operator Control Panel, and, if required, insert a blank or scratch cartridge into the I/O Station when requested.
  3. The test will execute.
    - If the test **PASSES**, resume normal library operations.
    - If the test **FAILS**, an error will be displayed. Make note of the error, then refer to “Isolating Drive Sled Problems” on page 7-9.
  4. Remove the cartridge from the I/O Station, if needed, then close the I/O Station.
  5. Press **Cancel** to exit the screen.
- **Drive Power** - use this item to turn drive power ON and OFF

**Note:** When configuration changes of a disabled drive are made from the Operator Control Panel (OCP), the drive powers ON after committing changes. When configuration changes of a disabled drive are made from the Web Interface (RMU), the drive does not power ON after committing changes.

### Service: Display Contrast

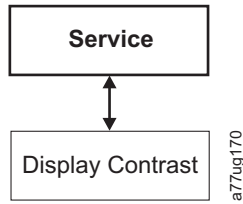

Figure 5-25. Service: Display Contrast menu

The following display contrast settings are available in this menu:

- The numbers **1** through **10** will display, with **10** being the lightest shade and **1** being the brightest.

### Service: Telnet Service Port

The Telnet Service Port menu item is to be used under the direction of Dell Technical Support.

## Web User Interface Menus

**Note:** Depending on the version of library firmware, there may be differences between the Menu description in this document and the web user interface menus on your library.

The following menus are available on the Web User Interface.

Table 5-5. Web User Interface Menus

#### [-] Monitor Library

- Library Identity
- Drives Identity
- Library Status
- Drives Status
- Inventory

#### [-] Manage Library

- Move Media
- Perform Inventory
- Release Magazine

#### [-] Configure Library

- General
- Logical Libraries
- Path Failover
- Encryption
- Drives
- Network
- User Access
- Date & Time
- Logs & Traces
- Email Notification

Table 5-5. Web User Interface Menus (continued)

- SNMP
- Save/Restore
- [- Service Library**
  - Clean Drive
  - Advanced Diagnostics (for Service Personnel only)
  - View Logs
  - View Drive Logs
  - Save Drive Dump
  - Perform Diagnostics
  - Key Path Diagnostics (if feature is available)
  - Upgrade Firmware
  - Reboot

## Monitor Library Menu

The **Monitor Library** menu contains the following sub-menu items.

- “Monitor Library: Library Identity”
- “Monitor Library: Drive Identity” on page 5-35
- “Monitor Library: Library Status” on page 5-37
- “Monitor Library: Drive Status” on page 5-38
- “Monitor Library: Inventory” on page 5-40

### Monitor Library: Library Identity

This page provides access to the static information about the library. No changes can be made from this page. Table 5-6 lists all available elements on the Library Identity page. An "X" indicates that the element displays for the specified library type.

Table 5-6. Library Identity page elements

Menu Item	Description	2U	4U
Service Tag	This is the unique identification number assigned by the manufacturer.	X	X
Product ID	This is the SCSI inquiry string of the library	X	X
Currently Installed Library Firmware	This is the current level of firmware installed on the library. For information on updating your firmware, refer to “Service Library: Upgrade Firmware” on page 5-62.	X	X
Bootcode Firmware Revision	This is the level of bootcode firmware currently installed on the library. Bootcode is the firmware that allows the library to begin initialization when it is powered ON.	X	X
Barcode Reader	This is the version of barcode reader in the library.	X	X
IPv4 Address	This is the Internet Protocol v4 Address assigned to your library.	X	X
Link local IPv6 address	This is the local IPv6 address assigned to your library.	X	X
IPv6 static assigned address	This is your library's IPv6 static assigned address.	X	X
Router discovery IPv6 address	This is the IPv6 router discovery address assigned to your library.	X	X



Table 5-6. Library Identity page elements (continued)

Menu Item	Description	2U	4U
MAC Address	This is the machine's access code assigned to your library.	X	X
WWide Node Name	This is the Worldwide Node Name assigned to your library.	X	X
Logical Library x Library Mode	The <b>Extended Logical Libraries Information</b> table displays information about the logical libraries currently assigned in your library. For each logical library in your library, either Random or Sequential Loop Autoload will be displayed.	X	X



Figure 5-26. The 4U library Monitor Library: Library Identity page

This view is correct for a library with multiple logical partitions. The Library Identify screen will be different for a library with a single logical partition.

### Monitor Library: Drive Identity

This page provides the following detailed information about the drive. No changes can be made from this page. The displayed information will vary depending on the library model and drive type (SCSI, SAS, or Fibre Channel). Table 5-7 lists all available elements on the Drive Identity page. An "X" indicates that the element displays for the specified drive type.

Table 5-7. Drive Identity page elements

Menu Item	Description	2U Library			4U Library		
		SCSI	Fibre	SAS	SCSI	Fibre	SAS
Vendor ID	This identifies the manufacturer of the tape drive.	X	X	X	X	X	X
Product ID	This is the SCSI inquiry string of the tape drive.	X	X	X	X	X	X
Serial Number	This is the unique identification number of the tape drive that was assigned by the manufacturer.	X	X	X	X	X	X
Firmware Revision	This is the current level of firmware installed on the drive. For information on updating your firmware, refer to "Service Library: Upgrade Firmware" on page 5-62.	X	X	X	X	X	X

Table 5-7. Drive Identity page elements (continued)

Menu Item	Description	2U Library			4U Library		
		SCSI	Fibre	SAS	SCSI	Fibre	SAS
SCSI ID	This is the unique identifier assigned to the SCSI drive to enable it to receive communications from the host computer.	X			X		
Element Address	This is the unique identifier assigned to the drive that allows the host to recognize and communicate with the drive.	X	X	X	X	X	X
Control Path Drive	If the drive communicates all messages from the host to the library, then it is considered the control path drive. If the drive is the control path drive, this element displays "Yes." If not, this element displays "No." All drives in a logical library may be a control path drive.	X	X	X	X	X	X
Data Compression	If the drive is compressing data, this element displays "Yes." If not, this element displays "No."	X	X	X	X	X	X
Interface Type	This identifies the drive host interface.	X	X	X	X	X	X
Node Name	This is the Worldwide node Name assigned to a Fibre drive.		X			X	
Worldwide ID	This is the Worldwide ID assigned to a SAS drive. (Ports A and B)			X			X
Port A	This provides information about Port A.		X			X	
Port Name	This is the name assigned to a Fibre channel port that is "enabled".		X			X	
Topology	This is the type of connection to the host.		X			X	
FC-AL Loop ID	This is the Fibre Channel - Arbitrated Loop ID of the drive.		X			X	
Speed	This is the current speed setting of the drive. Choices are Auto (where the drive will automatically negotiate the speed of the drive to match that of the server), 1Gb/s, 2Gb/s or 4 Gb/s.		X			X	
Port B	This provides information about Port B.			X			X

Drive Identity	1 (LUN)
Vendor ID	
Product ID	ULT3580-HH3
Serial Number	1068000539
Version	2
Firmware Revision	ACF1
World Wide ID - Port A	5000E11800245002
World Wide ID - Port B	5000E11800245003
Element Address	256
Control Path Drive	Yes
Data Compression	Yes
Interface Type	SAS

Drive Identity	2
Vendor ID	
Product ID	ULT3580-HH4
Serial Number	1K10000896
Firmware Revision	A23E
World Wide ID - Port A	5000E11800245005
World Wide ID - Port B	5000E11800245006
Element Address	257
Control Path Drive	No
Data Compression	Yes
Interface Type	SAS

a77ug288

Figure 5-27. The 4U library Monitor Library: Drive Identity page showing one Ultrium 3 SAS half high V2 drive (#1) and one Ultrium 4 SAS half high drive (#2)

### Monitor Library: Library Status

This page displays the dynamic information about the library, such as the current status of the components. No changes can be made from this page. Table 5-8 lists all available elements on the Library Identity page. An "X" indicates that the element displays for the specified library type.

Table 5-8. Library Status page elements

Menu Item	Description	2U	4U
Status	Library status is displayed using icons with text. A checkmark with the word "Ready" indicates the library is functioning properly. An exclamation point with the word "Caution" indicates the library can function, but is experiencing a problems. An X with the word "Error" indicates the library is not functioning because of a serious problem.	X	X
Cartridge in Transport	This identifies a cartridge that is currently being moved by the accessor. "None" is displayed if no cartridge is being moved.	X	X
Number of Moves	This is the number of times the accessor has moved a cartridge from Point A to Point B (for example, from a storage slot to a drive).	X	X
Total Power On Time	This is the total amount of time that the library has been powered ON.	X	X
Accessor Status	This is the current status of the accessor.	X	X
Left Magazine	This displays whether the left magazine is "Present" or "Not Present".	X	
Right Magazine	This displays whether the right magazine is "Present" or "Not Present".	X	
1. Left Magazine	This displays whether the lower left magazine is "Present" or "Not Present".		X

Table 5-8. Library Status page elements (continued)

Menu Item	Description	2U	4U
1. Right Magazine	This displays whether the lower right magazine is "Present" or "Not Present".		X
2. Left Magazine	This displays whether the upper left magazine is "Present" or "Not Present".		X
2. Right Magazine	This displays whether the upper right magazine is "Present" or "Not Present".		X

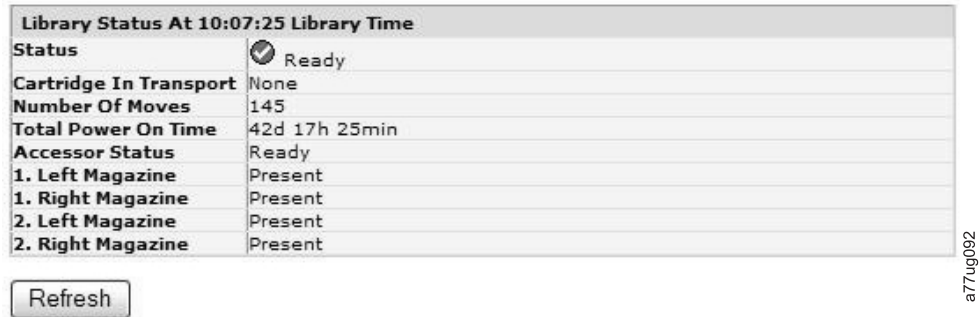

Figure 5-28. The 4U library Monitor Library: Library Status page

### Monitor Library: Drive Status

This page provides the following detailed dynamic information about the drive in the library. No changes can be made from this page. The displayed information will vary depending on the library model and drive type (SCSI, SAS, or Fibre Channel). Table 5-9 lists all available elements on the Drive Status page. An "X" indicates that the element displays for the specified drive type.

Table 5-9. Drive Status page elements

Menu Item	Description	2U Library			4U Library		
		SCSI	Fibre	SAS	SCSI	Fibre	SAS
Status	This is the current status of the drive. A checkmark indicates that the drive is operating properly. An exclamation point indicates that the drive is operating but has a problem. An X indicates that the drive is not operational because of a serious problem.	X	X	X	X	X	X
Cartridge in Drive	This is the serial number of the cartridge currently in the drive. If the drive does not contain a cartridge, "None" is displayed.	X	X	X	X	X	X
Drive Error Code	If the drive has generated an error code, it is displayed here. If the drive has not generated an error, "No Error" will be displayed.	X	X	X	X	X	X
Cooling Fan Active	This displays whether the drive's cooling fan is ON (checked) or OFF.	X	X	X	X	X	X
Drive Activity	This indicates whether or not the drive is operating.	X	X	X	X	X	X
Port A Status	This indicates whether Port A is logged on or out.		X			X	

Table 5-9. Drive Status page elements (continued)

Menu Item	Description	2U Library			4U Library		
		SCSI	Fibre	SAS	SCSI	Fibre	SAS
Port B Status	This indicates whether Port B is logged on or out.			X			X
Port Name	This is the name assigned to the Port on the drive.		X			X	
Speed	This is the current speed setting of the drive. Choices are Auto (where the drive will automatically negotiate the speed of the drive to match that of the server), 1Gb/s, 2Gb/s, or 4Gb/s.		X	X		X	X
Topology	This is the type of connection to the host. N-Port ID		X			X	
Hashed SAS Address	The Hashed SAS address is a value which is calculated from the WWID for use on the SAS interface			X			X
FC-AL Loop ID	This is the loop position number if the drive is in an arbitrated loop configuration.		X			X	
Encryption Status	This shows the status of any encryption that is enabled on the drive.		X	X		X	X
Encryption method	This is the type of encryption that is enabled on the drive.		X	X		X	X
Key path	This is the path used for transferring an encryption key. This setting is dependent upon the encryption method selected.		X	X		X	X
BOP policy	This indicates whether the Beginning of Partition (BOP) policy is enabled or disabled.		X	X		X	X
Density reporting	This setting determines whether the drive shows or masks encryption.		X	X		X	X

Drive 2 Status At 13:32:22 Library Time	
Status	✔ Idle
Cartridge In Drive	N.A.
Drive Error Code	No Error
Cooling Fan Active	✔
Drive Activity	Ready
Port A Status	Not ready, not connected
Speed	-
Hashed SAS address	000000
Encryption Status	
Encryption method	Disabled
Key path	Default by method
BOP policy	Disabled
Density reporting	Other

Drive 3 Status At 13:32:22 Library Time	
Status	✔ Idle
Cartridge In Drive	N.A.
Drive Error Code	No Error
Cooling Fan Active	✔
Drive Activity	Idle
Port A Status	No light detected

Refresh

a77ug093

Figure 5-29. The 4U library Monitor Library: Drive Status page

**Term Definitions:**

- **BOP (Beginning of Partition):** BOP (Beginning of Partition) is a SCSI term, which in a single partition format is the same as beginning of tape. It means that policy is determined on writes at LB zero. Appending to a tape [or overwriting at a non-zero LB] does not change the policy already in use for that tape.
- **Key Path:** This is the avenue where key resolution is performed. This is generally left to be determined by method (and is the same), but can be set differently for some hybrid modes.
- **Density Reporting:** This affects host reporting of density and is included to support legacy needs for transparency. The default of not masking encrypted densities means that the host can see a different density code for encrypted vs non-encrypted tapes (x72 [enc] as opposed to x52 [non-enc]). This feature masks this so the drive reports the primary density only. Normally this is set to the drive default (which is to show encr density).

**Monitor Library: Inventory**

This page provides detailed information about the tape inventory in the library. A summary of each magazine is shown. To get detailed information about the cartridges that reside in a magazine, click on the + button. This will expand the display for the magazine. To determine whether a cartridge is encrypted, refer to the Comments column in the Cartridge Details screen. See Figure 5-31 on page 5-42.

Inventory As Of 14:02:04 Library Time

### Drive Inventory

Drive	Status	Label	Source
1	Empty	-----	

### Magazine Inventory

8	9	10	11	+
4	5	6	7	
IO-Station	1	2	3	

23	22	21	20	+
19	18	17	16	
15	14	13	12	

Refresh

a77ug067

Figure 5-30. The 2U library Monitor Library: Inventory page

10	11	12	13	
----	----	----	----	--

Cartridge details for 2. Left Magazine

**1. Right Magazine - Slot inventory**

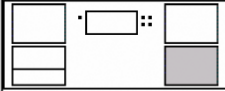
33	32	31	30	1. Right Magazine 
29	28	27	26	
25	24	23	22	

Cartridge details for 1. Right Magazine

**2. Right Magazine - Slot inventory**

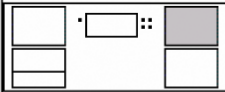
CLNI07L1 45	44	43	42	2. Right Magazine 
41	3SR023L3 40	39	38	
37	36	35	34	

Cartridge details for 2. Right Magazine

Slot #	Attn	Status	In Drive	Label	Media Loads	Comment
I/O Station 1	Closed	Empty		-----		
I/O Station 2	Closed	Empty		-----		
I/O Station 3	Closed	Empty		-----		
1		Empty		-----		
2		Empty		-----		
3		Empty		-----		
4		Empty		-----		
5		Full, Gen. 4		3IR115L4	6773	Encrypted
6		Full, Gen. 4		3FR016L4		
7		Full, Gen. 4		3IR101L4	3505	Encrypted
8		Empty		-----		
9		Empty		-----		

a77ug099

Figure 5-31. The 4U library Monitor Library: Inventory page

## Manage Library Menu

### Manage Library: Move Media

This page allows the user to move tape cartridges within the library. The source and destination are selected and then the MOVE button in the center of the screen is clicked to activate the move.



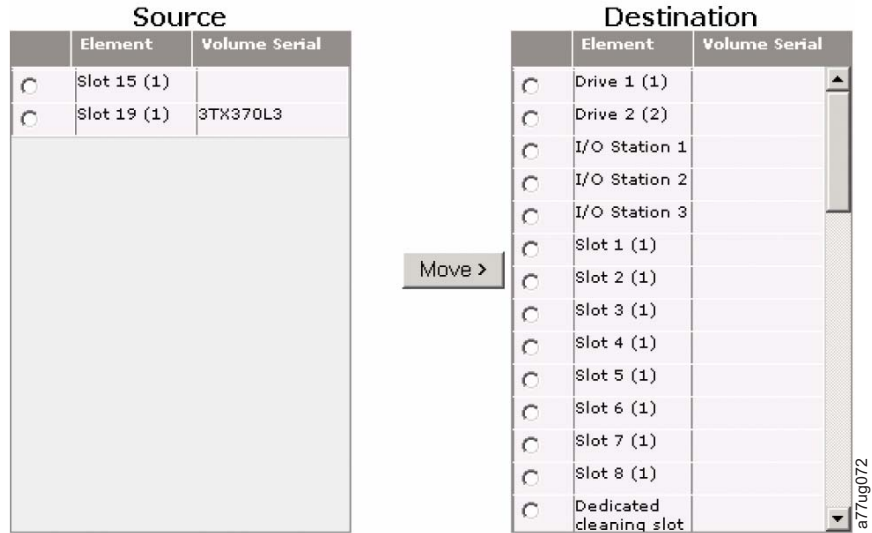

Figure 5-32. Manage Library: Move Media page

The following elements appear in the **Source** and **Destination** screens.

**Element**

In the **Source** screen, this identifies the library element that contains a cartridge. In the **Destination** screen, this identifies the library element that is empty and can receive a cartridge.

**Volume Serial**

In the **Source** screen, this element displays the serial number of the cartridge. In the **Destination** screen, this element contains no information.

**Manage Library: Perform Inventory**

This page allows the library to be re-scanned to determine the current media inventory.

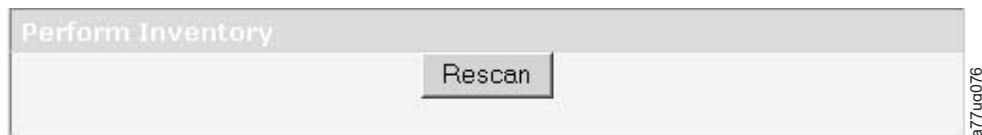

Figure 5-33. Manage Library: Perform Inventory page

**Manage Library: Release Magazine**

This page allows the user to release the right or left magazine from the library.

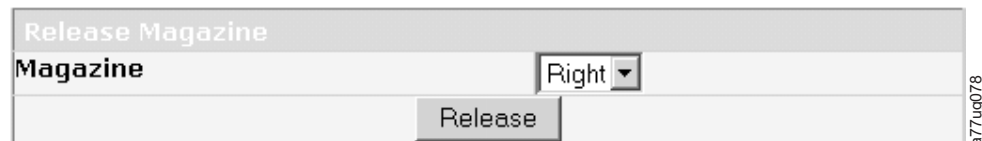

Figure 5-34. Manage Library: Release Magazine page

**Note:** To manually release a magazine, see “Releasing the Magazines Manually” on page 9-1. However, this manual process should only be used if the magazine cannot be released using the Operator Control Panel or the Web User Interface.

## Configure Library Menu

The **Configure Library** menu contains the following submenu items:

- "Configure Library: General"
- "Configure Library: Logical Libraries" on page 5-45
- "Configure Library: Path Failover" on page 5-46
- "Configure Library: Encryption" on page 5-47
- "Configure Library: Drives" on page 5-49
- "Configure Library: Network" on page 5-50
- "Configure Library: User Access" on page 5-52
- "Configure Library: Date & Time" on page 5-54
- "Configure Library: Logs & Traces" on page 5-54
- "Configure Library: Email Notification" on page 5-55
- "Configure Library: SNMP" on page 5-56
- "Configure Library: Save/Restore Configuration" on page 5-56

### Configure Library: General

This page allows you to make changes to general library configuration elements. As changes are made, they will only be applied after the **Apply Selections** or the **Submit** button is selected. After making the selection, a warning page will inform you of the impact of the proposed change. In some cases a pop-up screen will ask for confirmation. Many changes will also require a library reboot.

Table 5-10. Configure Library: General page elements

Menu Item	Description	2U	4U
Library Name	Enter the name of the library.	X	X
I/O Station Enabled	The I/O Station defaults to <b>I/O Station Enabled</b> . Choosing <b>Disabled</b> (no checkmark) adds one more storage slot to the 2U library, and 3 more storage slots to the 4U library. When the I/O Station is disabled, removing or adding media to the library must be performed by releasing the left and/or right magazine(s).	X	X
Auto Clean Enabled	Auto Clean defaults to <b>Disabled</b> . For Auto Clean to function, a cleaning cartridge (CLNxxxLx) must be resident in a reserved library slot and Auto Clean must be enabled (turned on). <b>Note:</b> If Auto Clean is enabled, and a cleaning cartridge is not resident in a reserved slot, the Auto Clean Status field in the web System Status screen will post a "Chk Media/Rsvd Slot" message.	X	X
Bar Code Label Length Reported To Host	The default bar code label length is 8, but can be set to 6. The bar code label length is a "reported" length. This setting will cause the host computer to only see the first 6 characters of the label or all 8 characters. This setting does not affect the bar code label that is shown on any of the library user interfaces (always shows all 8 characters).	X	X

Table 5-11. Configure Library: Specific page elements

Menu Item	Description	2U	4U
Library Mode	Choices are Random and Sequential. If you choose Sequential, you may also activate Autoload and/or Loop. If there is more than one logical library, there is a Library Mode entry for each logical library. <b>Important:</b> If a Logical Library in Sequential Mode contains more than one drive, only the first drive in the Logical Library will be utilized.	X	X

Table 5-11. Configure Library: Specific page elements (continued)

Menu Item	Description	2U	4U
Active Slots	It may be necessary to modify the number of active slots to agree with the number of slots allowed by your host software. To modify the number of active slots in your library, click on the drop down list and select the number of slots you want active in your library. Also, the Auto Clean function requires the cleaning cartridge to be in a DCS or reserved slot. Reserved slots are created by reducing the number of active slots.	X	X

The screenshot shows a web-based configuration interface for a library. It is divided into two main sections: 'General' and 'Extended Configuration for Logical Libraries'.

**General Section:**

- Library Name:** An empty text input field.
- I/O Station Enabled:** A checked checkbox.
- Auto Clean Enabled:** A checked checkbox.
- Barcode Label Length Reported To Host:** A dropdown menu currently set to '8'.

**Extended Configuration for Logical Libraries Section:**

This section is divided into two sub-sections, 'Logical Library 1' and 'Logical Library 2'.

**Logical Library 1:**

- Library Mode:** Radio buttons for 'Random' (selected), 'Sequential', 'Autoload', and 'Loop'.
- Active Slots:** A dropdown menu currently set to '21'.

**Logical Library 2:**

- Library Mode:** Radio buttons for 'Random' (selected), 'Sequential', 'Autoload', and 'Loop'.
- Active Slots:** A dropdown menu currently set to '23'.

At the bottom right of the form, there are two buttons: 'Refresh' and 'Apply Selections'. A small vertical text 'a77ug094' is located to the right of the 'Apply Selections' button.

Figure 5-35. The 4U library Configure Library: General and Extended page

### Configure Library: Logical Libraries

To partition your multi-drive library, select the number of logical libraries you would like to create in your library, then click **Submit**.

One cartridge magazine cannot be assigned to two logical libraries. If you partition a multi-drive library, each of the magazines must be assigned to a logical library on a magazine boundary. The entire magazine must be part of one logical library only. In a fully populated 4U library with four logical libraries, resource assignments will be as follows:

- Logical Library 1 will contain Drive 1 and the lower left cartridge magazines.
- Logical Library 2 will contain Drive 2 and the upper left cartridge magazines.
- Logical Library 3 will contain Drive 3 and the lower right cartridge magazine.
- Logical Library 4 will contain Drive 4 and the upper right cartridge magazine.

The I/O Station and the reserved slot (or dedicated cleaning slot (DCS) if one is assigned) are shared among all logical libraries.

**Note:** When reducing the number of drives in your library, update the Logical Library configuration. This will remove the Attention LED on the front panel and the exclamation mark on the Home screen indicating that a drive is missing.

Updating the Logical Library configuration will also update the drive element addressing and drive numbering. Replacing LTO half height drives with full height drives may require you to execute **Restore Factory Defaults** to correctly update the drive element addressing and drive numbering. See “Configure Library: Save/Restore Configuration” on page 5-56.

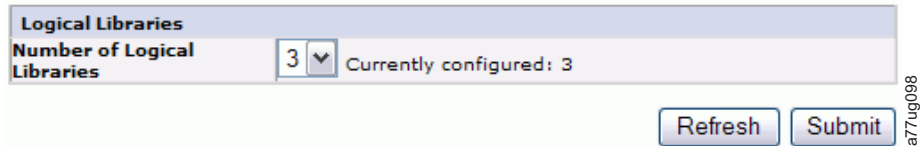

Figure 5-36. The 4U library Configure Library: Logical Libraries page

### Configure Library: Path Failover

This page allows the user to enter the Path Failover feature activation key (Supported on 4U library only for library firmware levels at or below 8.xx. Supported on both the 2U and 4U libraries with library firmware levels above 8.xx) For library firmware levels below 8.xx the Path Failover feature is available for select LTO 4 tape drives, and Path Failover is not supported for Half Height drives. Library firmware levels higher than 8.xx support Path Failover on LTO 5 drives, as well as LTO 4 Full Height drives. For more information, refer to the *Dell PowerVault TL4000 Failover Configuration Guide*, included with the library documentation.



Figure 5-37. The 4U library Configure Library: Path Failover page

Enter the Feature Activation key and click **Activate**. This page will display if you have entered the feature key correctly.

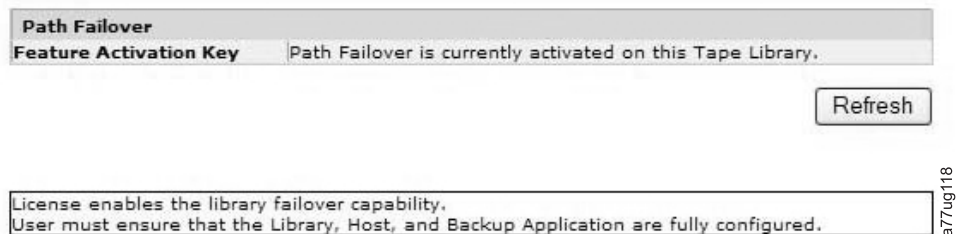

Figure 5-38. Path Failover license verification page

**Note:** Follow the instructions in the *Dell PowerVault TL4000 Failover Configuration Guide* to configure your environment for failover.

## Configure Library: Encryption

**Note:** Application Managed Encryption (AME) does not require a license key. Library Managed Encryption requires a license key. Contact your TSR (technical sales representative) to purchase this feature.

**Important:** The Advanced Encryption Settings are for Engineering Support use only. These fields should always be set to "No Advanced Setting".

Prerequisites for Application Managed Encryption:

- SAS and Fibre Channel LTO Ultrium 4 Tape Drive (Full Height or Half Height)

**Note:** Fibre Channel is full height drive only.

- Ultrium 4 Tape Cartridge
- Library firmware level 5.80 or higher
- Drive firmware level 77BE or higher
- Tape backup software application that supports LTO4 encryption

Prerequisites for Library Managed Encryption

- SAS and Fibre Channel LTO Ultrium 4 Tape Drive (Full Height or Half Height)

**Note:** Fibre Channel is full height drive only.

- Ultrium 4 Tape Cartridge
- Library firmware level 5.80 or higher
- Drive firmware level 77BE or higher
- Dell Encryption Key Manager application

### Setting or Changing a Drive's Method of Encryption

1. Enter your library's IP Address in an internet browser address field and press ENTER.
2. Log in to the Web User Interface. Refer to "Login" on page 2-5.
3. Expand **Configure Library** in the left navigation pane.
4. Click **Encryption**.

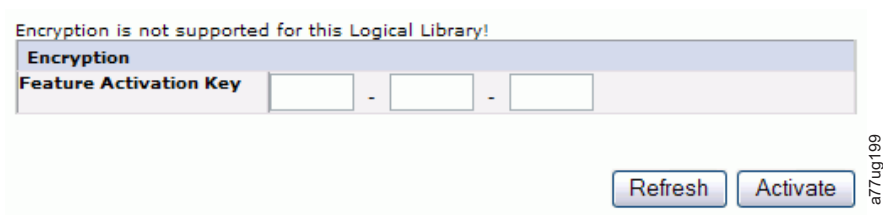

Figure 5-39. Feature Activation Key screen

5. On the **Encryption** screen, enter the **Feature Activation Key** to enable the library managed encryption options.
6. Click **Activate** to save the key and expand the screen for additional encryption settings.

<b>Encryption</b>	
Feature Activation Key	Encryption is currently licensed on this library.
Enable SSL for EKM	<input type="checkbox"/>
<b>Encryption Setting for Logical Library 1</b>	
Encryption method	Library Managed Encryption
Encryption policy	Encrypt All
<b>EKM Server Setting</b>	
Primary IP address (IPv4 or IPv6)	9.11.221.242
Primary TCP port	3801
Secondary IP address (IPv4 or IPv6)	0.0.0.0
Secondary TCP port	3801
<b>Encryption Setting for Logical Library 2</b>	
Encryption method	Library Managed Encryption
Encryption policy	Encrypt All
<b>EKM Server Setting</b>	
Primary IP address (IPv4 or IPv6)	9.11.221.242
Primary TCP port	0
Secondary IP address (IPv4 or IPv6)	0.0.0.0
Secondary TCP port	0
Refresh Submit	

a77ug190

Figure 5-40. Configure Library: Encryption Feature configuration screen

7. Select **Enable SSL for EKM** to enable Secure Sockets Layer for the Dell Encryption Key Manager application.
8. Select an **Encryption method**, from the pull down menu, for each logical library.
  - Without an encryption license key, select **None** or **Application Managed Encryption**.
  - With an encryption license key, select **Library Managed Encryption**.
9. Select an **Encryption policy**, from the pull down menu, for each logical library.
  - **Encrypt All**: This is the default policy. It encrypts all cartridges using the default data keys specified in the EKM. This setting applies to all drives in the TL2000/TL4000 logical library.
  - **Internal Label - Selective Encryption**: Check your tape backup software application documentation to see if this feature is supported.
  - **Internal Label - Encrypt All**: Check your tape backup software application documentation to see if this feature is supported.
10. A primary and secondary EKM server can be set for each logical library. Each partition has its own Encryption and EKM settings. Maintaining primary and secondary EKM servers is desired for maximum availability of encrypted backup and recovery. These settings are required for Library Managed Encryption only. Enter the **EKM Server Setting** information.
  - **Primary IP address (IPv4 or IPv6)**: Enter the IP address of the primary EKM server.
  - **Primary TCP port**: After entering the Primary IP address, the library will automatically set the value of the Primary TCP port.
  - **Secondary IP address (IPv4 or IPv6)**: Enter the IP address of the secondary EKM server.

- **Secondary TCP port:** After entering the **Secondary IP address**, the library will automatically set the value of the **Secondary TCP port**.

**Note:** The Default Port for TCP (SSL disabled) is **3801**. The Default Port for SSL is **443**. These values are the default values set by the library. They can be changed depending on the user configuration but the user has to make sure they match the EKM properties file.

**Note:** If SSL is enabled the encryption host configuration will request a SSL port instead of a TCP port. Review the *Dell PowerVault Encryption Key Manager User's Guide* for instructions to locate the appropriate port settings.

11. Click **Submit** to apply the changes.
12. Install the Dell Encryption Key Manager (EKM) application on your host. Refer to the Dell EKM documentation provided with your Encryption packet. The EKM IP address and EKM port will be provided to the user by the EKM application.

### Configure Library: Drives

This page allows you to modify the current ID assigned to a SCSI or Fibre Channel drive. This page allows any drive in the library to be powered off by de-selecting the check mark in the Power On box. The displayed information will vary depending on the library model and drive type (SCSI, SAS, or Fibre Channel). Table 5-12 lists all available elements on this page. An "X" indicates that the element displays for the specified drive type.

Table 5-12. Drive Identity page elements

Menu Item	Description	2U Library			4U Library		
		SCSI	Fibre	SAS	SCSI	Fibre	SAS
SCSI ID	For each SCSI drive, click on the drop down list and select the number of the slot in which the drive is located.	X			X		
Power On	For each drive, click in the box to power ON the selected drive.	X	X	X	X	X	X
Control Path	The control path drive communicates messages from the host to the library. Select this option for each drive that you want to be a control path drive. At least one drive in each logical library must be designated as a control path drive.	X	X	X	X	X	X
Port A Configuration:							
Speed	For each Fibre Channel drive, click on the drop down list and select Automatic, 1Gb/s, 2Gb/s, 4 Gb/s, or 8 Gb/s. Selecting Automatic will allow library speed to automatically negotiate to the current server speed.		X			X	
Topology	For each Fibre Channel drive, click LN-Port, L-Port, or N-Port.		X			X	
FC-AL Loop ID	This is the loop position number if the drive is in an arbitrated loop configuration.		X			X	
Port B Configuration:							
	Port B is supported for SAS full height drives only. <b>Note:</b> Port B is only supported for failover.			X			X

Drives	
<b>Drive 1 (Logical Library 1)</b>	<input checked="" type="checkbox"/> Power On <input checked="" type="checkbox"/> Control Path
Note: SAS drives do not require user configuration	
<b>Port A Configuration</b>	
Speed	Automatic ▾
Topology	LN-Port ▾
FC-AL Loop ID	5 ▾
<b>Port B Configuration</b>	Port not available

Refresh Submit

a77ug064

Figure 5-41. The Configure Library: Drives page for a 2U library

Drives	
<b>Drive 1 (Logical Library 1)</b>	<input checked="" type="checkbox"/> Power On <input checked="" type="checkbox"/> Control Path
<b>Drive 2 (Logical Library 2)</b>	<input checked="" type="checkbox"/> Power On <input checked="" type="checkbox"/> Control Path
SCSI ID	6 ▾
<b>Drive 3 (Logical Library 3)</b>	<input checked="" type="checkbox"/> Power On <input checked="" type="checkbox"/> Control Path
<b>Port A Configuration</b>	
Speed	Automatic ▾
Topology	LN-Port ▾
FC-AL Loop ID	6 ▾
<b>Port B Configuration</b>	Port not available

Refresh Submit

a77ug095

Figure 5-42. The Configure Library: Drives page for a 4U library

Click one of the following:

- **Refresh** - to cancel the changes made to the screen.
- **Submit** - to apply the changes made to the screen.

**Note:** When configuration changes of a disabled drive are made from the Operator Control Panel (OCP), the drive powers ON after committing changes. When configuration changes of a disabled drive are made from the Web Interface (RMU), the drive does not power ON after committing changes.

### Configure Library: Network

This page shows the current network configuration of the library and allows modification to the configuration. When a change is requested, a pop-up box checks confirms the request.

1. Click **Network** in the left navigation pane, to display the **Network** page.



Network	
Protocol Stack	IPv4 only
Host Name	FLX1068B0
Domain Name	storage.tucson.ibm.com
DNS Primary	9.11.224.130
DNS Secondary	9.11.224.114
Enable SSL For Web	<input type="checkbox"/>
Ethernet Settings	Auto
IPv4	
Enable DHCP	<input type="checkbox"/> On
Static Address	9.11.219.162
Network Mask	255.255.255.0
Gateway address	9.11.219.1
IPv6	
Enable DHCP	<input type="checkbox"/>
Enable Stateless Auto Config	<input checked="" type="checkbox"/>
Static Address	0:0:0:0:0:0:0:0
Prefix length	64
Gateway address	0:0:0:0:0:0:0:0

 You will be required to login again, or reboot the library, if changes are made. If you change the IP address of the library, you will need to use the new IP address when you attempt to access the library again.

a77ug074

Figure 5-43. Configure Library: Network Page

**Important:** Do not click the Submit button until all changes have been made to the Network page. Once the Submit button has been clicked, no other changes can be made until after the library has applied the current changes.

After the Submit button has been clicked, depending on the changes made, you will either be disconnected and need to login again or reboot the library.

Clicking the Refresh button will refresh the page and any changes made will not be retained.

2. Select a **Protocol Stack** - Choose **IPv4 only**, **IPv6 only**, or **Dual Stack IPv4 & IPv6**.

If you choose **Dual Stack IPv4 & IPv6**, you must be prepared to enter both IPv4 and IPv6 IP addresses. The sections below will gray out depending on the choices made here.

3. Enter the **Host Name**.
4. Enter the **Domain Name**.
5. **DNS Primary** - Enter the IP address of your primary DNS server.
6. **DNS Secondary** - Enter the IP address of your secondary DNS server.
7. **Enable SSL for Web** - If you desire to have SSL (Secure Sockets Layer) enabled, place a check in this box.

**Note:** If you get a security certificate alert when logging in to the Web User Interface, you can install the certificate or allow an exception (depending on the internet browser you are using). SSL is enabled when the URL begins with **https://** and some browsers will show a lock.

8. **Ethernet Settings** - Ethernet Settings choices are: **Auto** (the default), **10 Mbit/Half**, **10 Mbit/Full**, **100 Mbit/Half**, **100 Mbit/Full**. Please refer to <http://support.dell.com> to determine the availability of manual Ethernet settings in your library's firmware.
9. **Enter IPv4 settings (if applicable).**
  - a. **Enable DHCP** - Click this item ON to have the IP Address of your library automatically set by the DHCP server.
  - b. **Static Address** - Enter the assigned IPv4 address. The format of an IPv4 address is a 32-bit numeric address written as four numbers separated by periods.
  - c. **Network Mask** - Enter the assigned IPv4 Network Mask.
  - d. **Gateway address** - Enter the assigned IPv4 Gateway address. This address allows access outside the local network.
10. **Enter IPv6 settings (if applicable).**
  - a. **Enable DHCP** - Click this item ON to have the IP Address of your library automatically set by the DHCP server.
  - b. **Enable Stateless Auto Config** - Stateless Auto config is ALWAYS on (not defeatable).
  - c. **Static Address** - Enter the assigned IPv6 address. The format of an IPv6 IP address is a 128-bit numeric address written as 8 groups of four numbers separated by colons.
  - d. **Prefix length** - The default prefix length is set to 64, but can be set to any length, depending upon the address used.
  - e. **Gateway address** - Enter the assigned IPv6 Gateway address. This address allows access outside the local network.
11. Click one of the following:
  - **Refresh** - to cancel the changes made to the screen.
  - **Submit** - to apply the changes made to the screen.

**Note:** Depending on the changes made, you will either be disconnected and need to login again, or reboot the library. If a reboot is required, the following Warning message will appear after the Submit button is clicked.

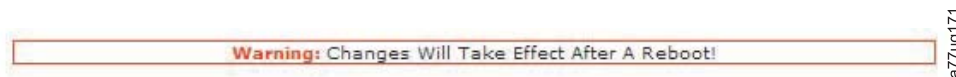

Figure 5-44. Warning Screen

The library must be rebooted or the changes will not take place.

### Configure Library: User Access

This page allows the user to add and modify user accounts. See "Login" on page 2-5 for information on user types.

The **Configure Library** → **User Access** page is only accessible to the Admin and Service login. Access is denied to User and Superuser logins.

The Admin login has access to all library functions except **Service Library** → **Advance Diagnostics**.

The Service login has access to all library functions including **Service Library** → **Advance Diagnostics**.

Roles	
<input type="checkbox"/> Disable Superuser	
<input type="checkbox"/> Disable User	

Passwords	
Role	User
New Password (Enter Up To Ten Characters)	.....
Repeat Password	.....

Support Contact	
Support Name	
Support Phone	
Support Email	

Refresh Submit

a77ug082

Figure 5-45. Configure Library: User Access page

The following elements are displayed on the **User Access** page.

**Role** The name associated with the chosen Access Level.

**Note:** Admin can select User, Superuser, and Admin roles. Service can select User, Superuser, Admin, and Service roles.

Check the **Disable Superuser** checkbox if you do not want **Superuser** to be listed on the Role listbox (i.e. prohibits Superuser login). Check the **Disable User** checkbox if you do not want **User** to be listed on the Role listbox (i.e. prohibits User login). Uncheck the checkbox(es) to allow **Superuser** or **User** login.

**New Password**

The password must be a maximum of ten characters (A-Z, a-z, 0-9, <space>, <hyphen>, <period>).

**Repeat Password**

Enter the New Password again.

**Support name**

The name of the individual within your company to contact for Web User Interface or library support.

**Note:** Only one support person can be configured for the entire tape library. The support person may or may not be one of the user, superuser, or admin account holders.

**Support phone**

The phone number of the individual within your company to contact for Web User Interface or library support.

**Support email**

The email address of the individual within your company to contact for Web User Interface or library support.

Click one of the following:

- **Refresh** - to cancel the changes made to the screen.

- **Submit** - to apply the changes made to the screen.

### Configure Library: Date & Time

This page allows the user to set the time and date, and how it will be displayed.

Date & Time			
Time (24H)	17	: 41	: 11
Date	Month : 04	Day : 11	Year : 2006

Refresh Submit

a77ug061

Figure 5-46. The Configure Library: Date & Time page

#### Time (24H)

Using a 24-hour format, enter the current hour, minutes, and seconds.

**Date** Enter the current month, day, and year.

Click one of the following:

- **Refresh** - to cancel the changes made to the screen.
- **Submit** - to apply the changes made to the screen.

### Configure Library: Logs & Traces

This page allows service personnel to set the error log mode to **Continuous** or to **Stop trace at first error**.

Logs & Traces		
<b>Error Log Mode</b>	<input checked="" type="radio"/> Continuous <input type="radio"/> Stop Trace At First Error <input type="radio"/> Stopped	
<b>Trace Level</b>	<input checked="" type="checkbox"/> Cmd <input checked="" type="checkbox"/> Response <input checked="" type="checkbox"/> Event <input checked="" type="checkbox"/> Trace Data <input checked="" type="checkbox"/> Low Level Trace <input checked="" type="checkbox"/> Recovered Error <input checked="" type="checkbox"/> Hard Error	
<b>Trace Filter</b>	<input checked="" type="checkbox"/> Main <input checked="" type="checkbox"/> Drive <input checked="" type="checkbox"/> CDB Interpreter <input checked="" type="checkbox"/> Robotic <input checked="" type="checkbox"/> Trace <input checked="" type="checkbox"/> OCP Input <input checked="" type="checkbox"/> OCP Output <input checked="" type="checkbox"/> SCSI Module <input checked="" type="checkbox"/> SDCI Module	

Refresh Submit

a77ug071

Figure 5-47. Configure Library: Logs & Traces page

It is recommended that you select **Continuous** for the **Error Log Mode** so that all information for logs and traces will be captured.

Click one of the following:

- **Refresh** - to cancel the changes made to the screen.
- **Submit** - to apply the changes made to the screen.

**Note:** The trace level and trace filter selection options are only changeable by Service personnel.

## Configure Library: Email Notification

This page allows the user to enter information for email notification. When set up correctly, **Email Notification** allows the library to send an email to a designated individual when the library is experiencing a problem.



Email Notification	
Notify Errors	<input type="checkbox"/> On
Notify Warnings	<input type="checkbox"/> On
To Email Address	<input type="text"/>
SMTP Server Address (IPv4)	<input type="text" value="d03av02.boulder.ibm.com"/> IPv4 address or Host
	name and domain *
Domain Name	<input type="text" value="storage.tucson.ibm.com"/>

Refresh Submit

a77ug065

Figure 5-48. Configure Library: Email Notification page

The following elements are displayed on the **Email Notification** page.

### Notify Errors

Select this item to be notified of library errors via email.

### Notify Warnings

Select this item to be notified of library warnings via email.

### To Email Address

Enter the email address of the individual you would like to receive the errors and/or warnings.

**Note:** The TL2000/TL400 email address field cannot be empty (clear). The email notification setup allows the user to turn off the feature by deselecting the **notify error** and **notify warnings** boxes. The user can add an invalid email as long as the email address format is correct (i.e. a@xxx.xxx).

### SMTP Server Address (IPv4 or IPv6)

Enter the address of the email server of the individual you would like to receive the errors and/or warnings. This can be an IPv4 or IPv6 address, or a host name and domain. If a host name and domain is listed, the IPv4 or IPv6 address will be resolved from the DNS using that name, and the address will be stored rather than the name. If the address changes, a new name or a new address will need to be entered.

### Domain Name

Enter the Domain Name for your library. This field cannot be blank when using email notification.

**Note:** If you attempt to enter a blank value for the Domain Name, a warning message will appear. It will say **If you are using Email Notification then a value is required for the Domain Name.**

Click one of the following:

- **Refresh** - to cancel the changes made to the screen.
- **Submit** - to apply the changes made to the screen.

## Configure Library: SNMP

This page shows the current SNMP configuration of the library and allows modification to the configuration. When a change is requested, a pop-up box checks to confirm the changes.

1. Click **SNMP** in the left navigation pane, to display the **SNMP** page.

SNMP	
Enabled	<input checked="" type="checkbox"/>
Target 1 - IP Address	9.11.219.229 <span style="float: right;">Version <b>SNMPv2</b> ▾</span>
	<small>IPv4 address or Host name and domain *</small>
Target 2 - IP Address	0.0.0.0 <span style="float: right;">Version <b>SNMPv2</b> ▾</span>
	<small>IPv4 address or Host name and domain *</small>
Target 3 - IP Address	0.0.0.0 <span style="float: right;">Version <b>SNMPv3</b> ▾</span>
	<small>IPv4 address or Host name and domain *</small>
Community Name	public
Security User Name	initial
Audit Logging	<input checked="" type="checkbox"/>

a77ug278

Figure 5-49. Configure Library: SNMP Page

### 2. Enter SNMP settings.

- a. **Enabled** - Check this box to have SNMP traps sent to a SNMP Management console(s).
- b. **Target 1-IP Address** - If SNMP traps are enabled, enter an IP address where SNMP traps are to be sent.
- c. **Target 2-IP Address** - Enter an optional 2nd IP address where SNMP traps are to be sent, or leave as 0.0.0.0.
- d. **Target 3-IP Address** - Enter an optional 3rd IP address where SNMP traps are to be sent, or leave as 0.0.0.0.
- e. **Version** - The library offers three versions of the SNMP protocol; v1, v2 and v3. Select a version for each Target IP Address.
- f. **Community Name** - An SNMP community name is a text string that acts as a password to authenticate messages sent between the SNMP remote management application and the library. Enter your preferred name, or leave as "public". The Community Name is limited to 33 alpha-numeric characters (A-Z, a-z, 0-9).
- g. **Audit Logging** - If SNMP is enabled and Audit Logging is enabled, the library will send SNMP traps to an SNMP Management console(s) when the library or tape drive configuration has changed.

**Note:** This option is only available if the library firmware is 9.00 or higher, and the latest library MIB file has been added to the SNMP Management console.

### 3. Click one of the following:

- **Refresh** - to cancel the changes made to the screen.
- **Submit** - to apply the changes made to the screen.

## Configure Library: Save/Restore Configuration

This page allows the library configuration to be reset to the factory defaults.

Saving and restoring configuration data can be done using the Remote Management Unit (RMU) and/or the Operator Control Panel (OCP). The feature has been implemented on the RMU and on the OCP, but with slightly different functionality.

**Note:** Configuration files saved with one version of library firmware may not be compatible with other versions of firmware. It is recommended to save a configuration file each time the library firmware is upgraded. Restore the library using a configuration file that was saved with the same version of firmware currently installed in the library.

Since the RMU can be accessed remotely, its implementation will save/restore the configuration data to/from a file on the host site. When entering commands on the OCP, the unit is accessed directly. For this reason the OCP implementation will save/restore the configuration data to/from a USB memory stick that is inserted into the USB connector on the library controller.

**Note:** Factory defaults must be restored when the library drive is changed from a LTO half height to full height configuration, in order for the library to correct the element addressing and drive numbering. If a new drive is added to the library configuration, a restore factory default is not required.



Figure 5-50. Configure Library: Save/Restore page

## Service Library Menu

Some Service Library functions will post a warning message stating that the library should be taken offline from the host before performing any Service functions. It is up to the operator to ensure that it is taken offline at the host. Before performing any service functions, ensure the host is not performing any data writing or retrieval.

### Service Library: Clean Drive

If the library is not configured for Auto Clean, this page allows the user to manually clean the tape drive.

A drive cleaning should only be performed after the library/drive has posted a status message indicating Cleaning Required

To manually perform a drive cleaning, perform the following steps:

1. Select a cleaning cartridge listed in the Slot # field.
2. Select a drive listed in the Drive field.
3. Click the **Clean** button. See Figure 5-53 on page 5-58.

Drives that do not require a cleaning are labeled with **No Cleaning Required**. See Figure 5-51 on page 5-58.

Clean Drive	
Slot #	I/O Station 2
Drive	1 - No Cleaning Required
Clean	

Figure 5-51. No Cleaning Required

If there is no cleaning cartridge in the library, the **Clean** button can not be selected and the Slot # will display N.A.. See Figure 5-52

Clean Drive	
Slot #	N.A.
Drive	1
Clean	

Figure 5-52. No Cleaning Cartridge in Library

**Note:** If the library is configured for Auto Clean, and a cleaning cartridge is resident in a reserved slot, the library will automatically load the drive with a cleaning cartridge. The drive will perform a cleaning and the library will return the cleaning cartridge to the reserved slot. If Auto Clean is enabled and a cleaning cartridge is **not** present in a reserved slot, Auto Clean status on the Web User Interface Status screen will show **Chk Media/Rsvd Slot**.

Clean Drive	
Slot #	45
Drive	3
Clean	

Figure 5-53. Service Library: Clean Drive page

## Service Library: Advanced Diagnostics (for Service Personnel Only)

This menu is for use by Service Personnel only.

### Service Library: View Logs

This page allows the library logs to be viewed after entering the following:

- Log Type
  - **Error Trace:** Logs all the error messages
  - **Informational Trace:** Logs all the informational messages created as the library operates
  - **Warning Trace:** Logs all warning messages created by the library. Warning messages will not stop a library's operation but does remind the user of issues that may become a problem. Example: Invalid Media.
  - **Configuration Change Trace:** Logs any configuration changes made, such as changing/adding partitions, changing SCSI addresses, removing a DCS, etc.
  - **Standard Trace:** Logs all library operations

**Note:** Ensure that all the pop-up facilities on the web browser are set to enable pop-up boxes to appear. For example, on Microsoft Internet Explorer, under **Tools**, ensure that the Pop-up Blocker is turned OFF and **Internet**



**Options** → **Security** → **Custom Level** → **Downloads** → **Automatic Prompting** for file Downloads and **File Downloads** are both Enabled.

- Total Number of Entries
- Start Entry
- Number of Entries per Page
- View
- Clear Log - Clears the log you are viewing
- Dump Log - Dumps the log you are viewing
- Save Service Dump - Creates a DPA (Dump All) log output that can be viewed or saved to a file

<Prev | Next> buttons appear if the number of logs entries exceeds the number of entries per page. Click <Prev | Next> to index through the log entries. The 'Next' button will not be displayed if the log has more fewer entries than the '# of entries per page' setting. After clicking the 'Next' button, the 'Prev' button will be displayed. If the log entries fit on a single page the <Prev | Next> buttons do not appear.

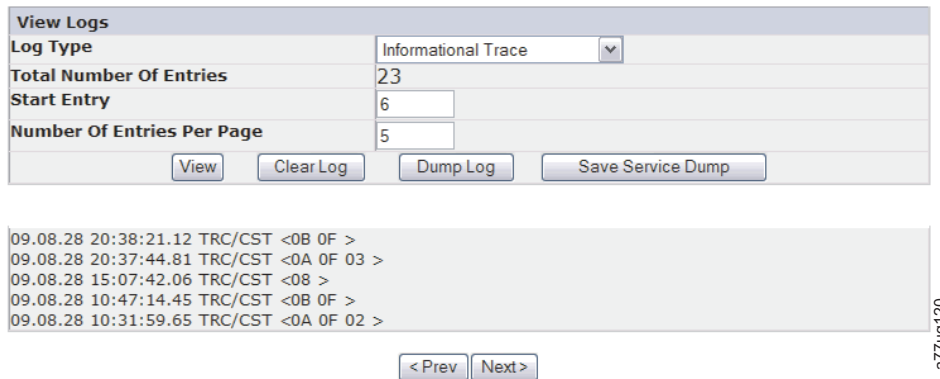

Figure 5-54. Service Library: View Logs page

### Service Library: View Drive Logs

This page allows the drive logs to be viewed after selecting the following:

- Log Type
  - **Error:** Logs drive error code information.
  - **SCSI:** Logs ASC/ASCQ and FSC information.
- Additional Sense Code (ASC)
- Additional Sense Code Qualifier (ASCQ)
- Fault Symptom Code (FSC)



Figure 5-55. Service Library: View Drive Logs screen

### Service Library: Save Drive Dump

This menu item allows a drive dump to be saved to the host computer. Select the drive. Then click **Save Drive Dump**. Once the **Save Drive Dump** button is clicked, the user will have the option of saving the drive dump to their hard drive. The progress status for the drive dump is shown on the System Status screen to the right of the main Web User Interface screen.

**Note:** Ensure that all the pop-up facilities on the web browser are set to enable pop-up boxes to appear. For example on the Microsoft Internet Explorer, under **Tools**, ensure that the Pop-up Blocker is turned OFF and **Internet Options -> Security -> Custom Level -> Downloads -> Automatic Prompting** for file **Downloads** and **File Downloads** are both Enabled.

Once saved on the hard drive, it can be e-mailed to Tech Support for analysis, if needed.

**Note:** The dump may take as long as 20 minutes to complete. The **System Status** portion of the screen shows "Drive Dump in Progress" with the number of KBs transferred.



Figure 5-56. Service: Save Drive Dump

### Service Library: Perform Diagnostics

**Note:** When running the "System Test", the library must contain at least the same number of data cartridges as there are drives in that library. For example, if your library has 4 drives installed, you must have 4 or more data cartridges in the library prior to the start of the test. If there are fewer data cartridges than drives in the library, an error message "Slot Empty" will occur, and the test will not complete successfully. The media type must be compatible with the drive type. Otherwise, an error message "Incompatible Media" will occur and the test will fail.

This page provides the system administrator with general tests to verify the usability and reliability of the library. The "System Test" will use resident data cartridges to test the load and unload capability of the drives, and ensure that the library mechanics are working satisfactorily. No data will be written to the cartridges and the cartridges will be returned to their normal slot location. The "Slot To Slot" test will move each resident data cartridge from one slot to another, for each test cycle requested. When completing the "Slot To Slot" test, you will need to Inventory your library before placing it back online, since this test scrambles the cartridge slot locations.

The user selects the number of test cycles before starting the test from the EXECUTE button. To cancel the test before it completes the cycles, select the STOP button.

**Note:** The Web User Interface System Status screen will indicate progress and completion of the activity.

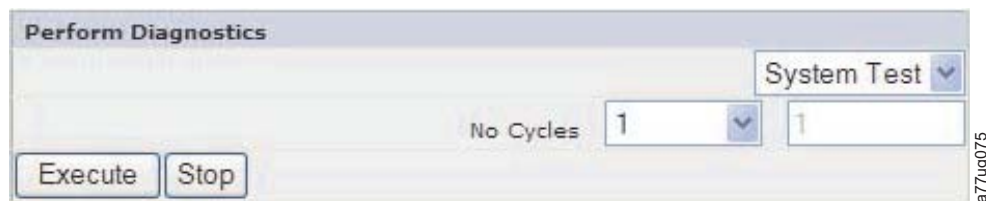

Figure 5-57. Service Library: Perform Diagnostics page

The first field can be modified to set the number of cycles. The second field displays the cycles completed.

### Service Library: Key Path Diagnostics

Please refer to <http://support.dell.com> to determine the availability of this feature.

**Important:** Ensure that library firmware and drive firmware are up to date before running the Key Path Diagnostic. Library firmware level must be greater than 6.xx. See "Verifying/Updating Firmware" on page 4-18.

The key path diagnostics test provides the ability to perform diagnostics on the encryption key path. Only drives that are set up for library managed encryption will be tested. Only encryption capable drives in logical libraries that are configured for Library Managed Encryption will be tested. To configure the library for encryption, refer to "Configure Library: Encryption" on page 5-47.

The test consists of four parts:

- **Drive Test:** The library performs a drive communication test to confirm communication with the drive.
- **Ethernet Test:** For each EKM IP address, the library performs a ping test and records the results.
- **EKM Path Test:** For each EKM IP address that passed the ping test, the library performs an EKM communication test.
- **EKM Config Test:** This test confirms that a drive is correctly configured in the EKM to service key requests.

To run the Key Path Diagnostic, complete the following procedure.

1. Log on to the Web User Interface. Refer to "Login" on page 2-5.

2. Quiesce all drives, then unload all drives.
3. Click **Service Library**, then **Key Path Diagnostics**.

Drive	IP Address	Drive Test	Ethernet Test	EKM Path Test	EKM Config Test
1	9.11.221.224	Passed	Passed	Failed	N/A
	9.11.221.242	Passed	Passed	In Progress	
2	N/A				
	N/A				
3	9.11.221.204	Passed	Passed	Failed	N/A
	9.11.221.224	Passed	Passed	In Progress	

Figure 5-58. Service Library: Perform Key Path Diagnostics page

4. Click **Start Tests**.

**Note:** If you have just enabled encryption on your library, wait for all LME drives to be displayed in the table and the **Start Tests** button to become active.

Each test will show a result of "Passed" or "Failed". If a test fails the remaining tests will not be executed, and the test will show a result of "N/A". The IP Address may show "N/A" for the following reasons:

1. Drive is not encryption capable.
2. EKM Server Settings, on the **Configure Library** → **Encryption** page, are not configured correctly.

Test results will clear:

- When the test is rerun
- When the library is rebooted

The time and date of the last test will appear below the Key Path Diagnostics screen. If any of the tests fail, refer to Chapter 7, "Troubleshooting," on page 7-1 for additional information.

## Service Library: Upgrade Firmware

**Note:** Library firmware and tape drive firmware are verified and released together. When updating to the latest firmware, verify that all installed components such as tape drive(s), and library are at the latest levels noted on the Support web site. Mixing different levels of library and tape drive firmware is not supported and may cause unpredictable results.

This page displays the current library and drive firmware versions. Firmware can be downloaded to the host then uploaded to the drive or library by using this page.

Click **Browse...** to choose the firmware file you have downloaded from the web site for the library or drive you want to update. (You can update only one device at a time). Be sure you choose the correct firmware for the library or drive type. Click the **Update** button to initiate the file transfer and firmware update.

**Note:** During the update no host drive action is possible. The drive update takes approximately 5 minutes. The system status panel (in the right of the browser window) will change from "update" to "ready".

If incompatible firmware is transferred to the library or drive the Update function will terminate with a message indicating incompatible firmware. If the library has a BCR (Barcode Reader) that requires 9.00 or greater firmware, the Update function will terminate with a message indicating the library requires firmware 9.00 or higher.

To ensure that the drive is being updated with the correct firmware refer to the drive identification information provided in the Upgrade Library Firmware banner. Ensure the drive firmware is for the correct drive type (e.g. Full Height, Half Height), correct protocol (e.g. SCSI, SAS, Fibre Channel) and correct version (V2). Drive code for V2 drives is not compatible with drives that are not V2.

#### V2 Drive Firmware Compatibility

- ULT3580-HH3 drives
  - Firmware for the LTO3 HH drive is not compatible with the LTO3 HH V2 drive
  - Firmware for the LTO3 HH V2 drive is not compatible with the LTO3 HH drive
- ULT3580-HH4 drives
  - Firmware for the LTO4 HH drive is not compatible with the LTO4 HH V2 drive
  - Firmware for the LTO4 HH V2 drive is not compatible with the LTO4 HH drive
- ULT3580-HH5 drives
  - The latest firmware for the LTO5 HH drive is compatible with all LTO5 HH drives. Upgrade the drive with the latest firmware if the drive Update function terminates with a message indicating incompatible firmware.

<b>Upgrade Library Firmware</b>	
Currently Installed Library Firmware	10gA
Library Firmware File	<input type="text"/> <input type="button" value="Browse..."/>
<input type="button" value="Update"/>	
<b>Upgrade Drive 1 (LTO3 HH SAS V2) Firmware</b>	
Drive Firmware Revision	ACF1
Drive Firmware File	<input type="text"/> <input type="button" value="Browse..."/>
<input type="button" value="Update"/>	
<b>Upgrade Drive 2 (LTO4 HH SAS) Firmware</b>	
Drive Firmware Revision	A23E
Drive Firmware File	<input type="text"/> <input type="button" value="Browse..."/>
<input type="button" value="Update"/>	

Figure 5-59. The Service Library: Upgrade Firmware page showing one Ultrium 3 SAS Half High V2 drive and one Ultrium 4 SAS Half High drive.

## Service Library: Reboot

**Important:** Some options of the Web User Interface take the library OFFLINE. This inactive mode can interfere with host-based application software,

causing data loss. Ensure that the library is idle before attempting to perform any remote operations that will take the library OFFLINE.

This page is used to perform a library reboot. There is a default time delay when the Web User Interface page refreshes itself. This time should be sufficient to reload the page. However, during a reboot, the connection to the library may be lost. If the connection is lost, the user will have to reload the page manually.

Click the **Reboot** button to initiate the reboot.

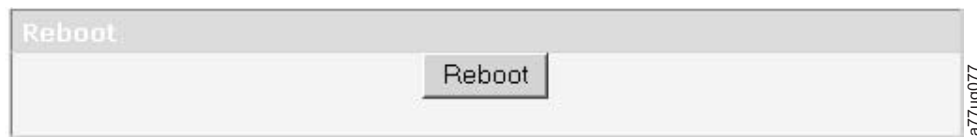

Figure 5-60. Service Library: Reboot page

---

## Import and Export Media during Normal Library Operation

### Import Media

Data cartridges can be inserted and taken out of a magazine while the library is in operation. If the library contains an I/O Station, and you wish to import media, follow these steps:

1. From the OCP Main Menu, select **Control** → **Open I/O Station**. The I/O Station will unlock itself.
2. Pull out the magazine and insert a data cartridge(s) into the I/O Station. On a 2U library, only 1 cartridge can be inserted at a time. On the 4U library, 3 cartridges can be inserted at one time.
3. Close the door of the I/O Station. The library will automatically start an inventory. The cartridges in the I/O Station will be counted but unassigned until they are moved into storage slots.
4. From the OCP Main Menu, select **Control** → **Move Cartridges** and move the data cartridges into the desired data slots. See “Control: Move Cartridges” on page 5-16 or “Manage Library: Move Media” on page 5-42 for more information.

If the library does not have an I/O Station (all slots are assigned to storage), and you wish to import media, you will need to release a magazine and insert the cartridges manually following these steps:

1. From the OCP Main Menu, select **Control** → **Magazine**. Choose the desired magazine to unlock/remove.
2. Pull out the magazine and insert a data cartridge(s) into the empty slots.
3. Push the magazine back into the library. The library will automatically start an inventory.
4. To move cartridges in the magazine once they are inserted, from the OCP Main Menu, select **Control** → **Move Cartridges** and move the data cartridges into the desired slots. See “Control: Move Cartridges” on page 5-16 or “Manage Library: Move Media” on page 5-42 for more information.

**Note:** If you run a library configuration backup program on your host computer, use the program to run an audit of the library after new cartridges have been added to update the backup program.

## Export Media

To remove cartridges from your library using your I/O Station, follow these steps:

1. From the OCP Main Menu, select **Control** → **Move Cartridges** and move the data cartridges into the I/O Station. See “Control: Move Cartridges” on page 5-16 or “Manage Library: Move Media” on page 5-42 for more information.
2. From the OCP Main Menu, select **Control** → **Open I/O Station**. The I/O Station will unlock itself
3. Pull out the magazine and take the data cartridge(s) out of the I/O Station
4. Push the magazine back into the library. The library will automatically start an inventory of the I/O station.

If you do not have an I/O Station (all slots are assigned to storage), and wish to export media, you will need to release a magazine and take out the cartridges manually following these steps:

1. From the OCP Main Menu, select **Control** → **Magazine**. Choose the magazine you wish to unlock/remove.
2. Pull out the magazine and remove the desired data cartridge(s).
3. Push the magazine back into the library. The library will automatically start an inventory.

**Note:** If you run a library configuration backup program on your host computer, use the program to run an audit of the library after cartridges have been removed to update the backup program.

---

## Configuring I/O Stations and Reserving Slots

2U libraries usually have 1 slot for an I/O Station, while 4U libraries have 3 slots assigned as an I/O Station. These slots can be configured as storage if needed.

To configure the I/O Station using the Web User Interface, follow these steps.

- Go to **Configure Library->General**.
- To enable the I/O Station, place a check mark in the **I/O Station Enabled** box. If it is checked as enabled, the first 3 physical slots in the lower left magazine in a 4U or the first physical slot in the left magazine in a 2U is configured as an I/O station. If the I/O Station Enabled box is not checked, the slots are configured as storage.

**Note:** The number of I/O Station slots and storage are automatically assigned when the **I/O Station Enabled** box is checked or unchecked.

### Dedicated Cleaning Slot

Earlier versions of the 4U library contained a Dedicated Cleaning Slot (DCS). This DCS can be retained and is supported by future library firmware updates. Library firmware after 1.95 will allow removal of the DCS, thus enabling this slot to be used as a storage slot.

To remove the DCS, perform the following procedures using the Operator Control Panel (OCP).

1. Navigate to the Library Settings (Logical Library Settings) screen **Configure > Library Settings (or Logical Library Settings)**.
2. Select **General**.

3. Scroll down to **Remove DCS**.
4. Select **No** or **Yes**.
5. Select **Save** then press the **Enter** button.

**Attention:** If your library originally contained a Dedicated Cleaning Slot and was removed, it can only be reinstated by restoring factory default settings.

To enable automatic cleaning of the drives when needed, a slot must be reserved, a cleaning cartridge must be present in the reserved slot, and Auto Clean must be enabled.

## Reserving Slots

Reserving a slot is accomplished by reducing the **Active Slot** count in any particular logical library. Slots are reserved beginning with the last available slot in the last magazine of the library. A cleaning cartridge in a reserved slot is available to any logical library drive even if the reserved slot is not in that logical library. Typically, if the library contains multiple logical libraries, the last logical library is chosen for the reserved slot containing the cleaning cartridge. As with a library with a single logical library, this slot is the last physical slot in the library (top right magazine, uppermost rear slot).

**Note:** Configure the required number of reserved slots prior to enabling Auto Clean.

To reserve a cleaning slot, follow these steps.

- To reserve slots in your library, go to the Web User Interface at “Choosing General Library Settings” on page 4-19 or the Operator Control Panel at “Configure: Library” on page 5-20 to get directions on reducing the Active slot count.



---

## Chapter 6. Using Ultrium Media

Figure 6-1 shows the LTO Ultrium 1500 GB Data Cartridge and its components.

- |          |                      |          |                      |
|----------|----------------------|----------|----------------------|
| <b>1</b> | LTO cartridge memory | <b>4</b> | Write-protect Switch |
| <b>2</b> | Cartridge door       | <b>5</b> | Label area           |
| <b>3</b> | Leader Pin           | <b>6</b> | Insertion guide      |

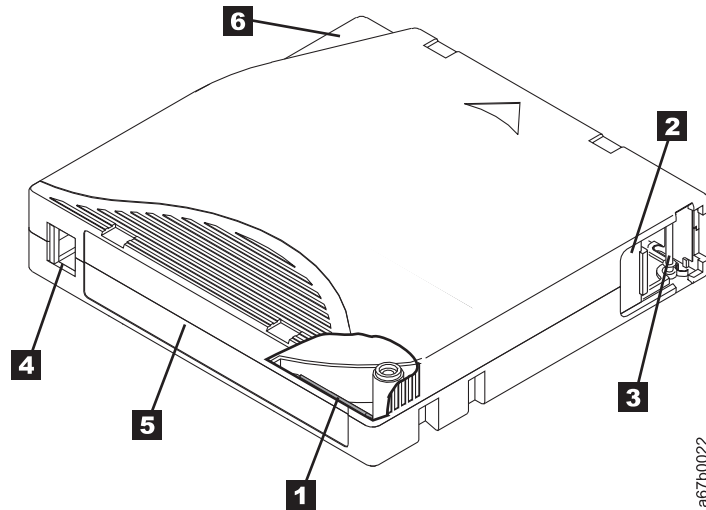

Figure 6-1. The LTO Ultrium 1500 GB Data Cartridge

**Note:** The same components are on all the other LTO Ultrium Data Cartridges.

---

### Data Cartridges

The different generations of Ultrium data cartridges can be identified by color:

Type	Color
Ultrium 5	Burgundy
Ultrium 5 WORM	Burgundy and Silvery gray
Ultrium 4	Green
Ultrium 4 WORM	Green and Silvery gray
Ultrium 3	Slate Blue
Ultrium 3 WORM	Slate Blue and Silvery gray
Ultrium 2	Purple
Ultrium 1	Black

All generations contain 1/2-inch, dual-coat, metal-particle tape.

When processing tape in the cartridges, Ultrium Tape Drives use a linear, serpentine recording format. The native data capacity and recording format of Ultrium data cartridges is as follows:

Type	Native Data Capacity	Recording Format
Ultrium 5	1500 GB (3000 GB at 2:1 compression)	Reads and writes data on 1280 tracks, sixteen tracks at a time
Ultrium 4	800 GB (1600 GB at 2:1 compression)	Reads and writes data on 896 tracks, sixteen tracks at a time.
Ultrium 3	400 GB (800 GB at 2:1 compression)	Reads and writes data on 704 tracks, sixteen tracks at a time
Ultrium 2	200 GB (400 GB at 2:1 compression)	Reads and writes data on 512 tracks, eight tracks at a time
Ultrium 1	100 GB (200 GB at 2:1 compression)	Reads and writes data on 384 tracks, eight tracks at a time

The first set of tracks (sixteen for Ultrium 5, 4 and 3) is written from near the beginning of the tape to near the end of the tape. The head then repositions to the next set of tracks for the return pass. This process continues until all tracks are written and the cartridge is full, or until all data is written.

The cartridge door **2** protects the tape from contamination when the cartridge is out of the drive. The tape is attached to a leader pin **3**, behind the door. When the cartridge is inserted into the drive, a threading mechanism pulls the pin (and tape) out of the cartridge, across the drive head, and onto a non-removable take-up reel. The head can then read or write data from or to the tape.

The write-protect switch **4** prevents data from being written to the tape cartridge. For more information, see “Write-Protect Switch” on page 6-6.

The label area **5** provides a location to place a label. .

The insertion guide **6** is a large, notched area that prevents the cartridge from being inserted incorrectly.

Table 6-1. Nominal Cartridge Life: Load/Unload Cycles

Type	Load/Unload Cycles
Ultrium 5	20,000 (20k)
Ultrium 4	20,000 (20k)
Ultrium 3	20,000 (20k)
Ultrium 2	10,000 (10k)
Ultrium 1	5000 (5k)

## Cartridge Compatibility

Table 6-2. Ultrium data cartridge compatibility with Ultrium tape drive

Tape Drive	LTO Ultrium Data Cartridges				
	1500 GB (Ultrium 5)	800 GB (Ultrium 4)	400 GB (Ultrium 3)	200GB (Ultrium 2)	100GB (Ultrium 1)
Ultrium 5	Read/Write	Read/Write	Read only		
Ultrium 4		Read/Write	Read/Write	Read only	
Ultrium 3			Read/Write	Read/Write	Read only
Ultrium 2				Read/Write	Read/Write

Table 6-2. Ultrium data cartridge compatibility with Ultrium tape drive (continued)

Tape Drive	LTO Ultrium Data Cartridges				
	1500 GB (Ultrium 5)	800 GB (Ultrium 4)	400 GB (Ultrium 3)	200GB (Ultrium 2)	100GB (Ultrium 1)
Ultrium 1					Read/Write

## WORM (Write Once, Read Many)

Certain records retention and data security applications require a Write Once, Read Many (WORM) method for storing data on tape. The LTO Ultrium 5 drive enables WORM support when a WORM tape cartridge is loaded into the drive.

### WORM Media

Because standard read/write media are incompatible with the WORM feature, a specially formatted WORM tape cartridge (see Figure 6-2) is required. Each WORM cartridge has a unique, worldwide cartridge identifier (WWCID), which comprises the unique CM chip serial number and the unique tape media serial number. Ultrium 5 WORM cartridges are two-tone burgundy and silvery-gray.

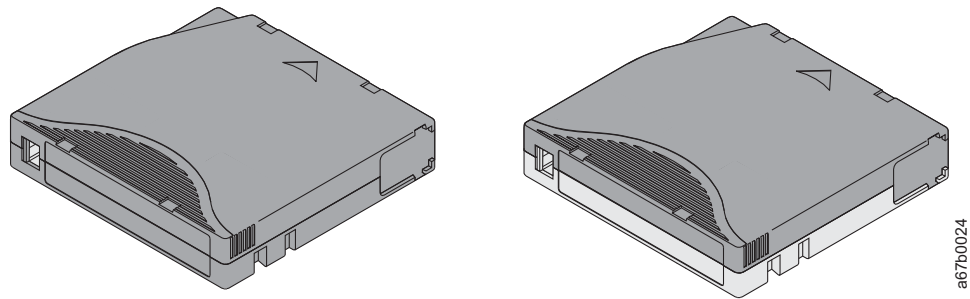

Figure 6-2. Ultrium Data and WORM Tape Cartridges

### Data Security on WORM Media

Certain built-in security measures help ensure that the data written on a WORM cartridge does not become compromised, for example:

- The format of an Ultrium 4 800 GB or Ultrium 3 400 GB WORM Tape Cartridge is unlike that of standard read/write media. This unique format prevents a drive that lacks WORM-capable firmware from writing on a WORM tape cartridge.
- When the drive senses a WORM cartridge, the firmware prohibits the changing or altering of user data already written on the tape. The firmware keeps track of the last appendable point on the tape.

### WORM Media Errors

The following conditions cause WORM media errors to occur:

- Information in the servo manufacturer's word (SMW) on the tape must match information from the cartridge memory (CM) module in the cartridge. If it does not match, a media Error Code 7 will post on the drive's single-character display (SCD). An error will also be displayed on the Operator Control Panel.

- Inserting a WORM tape cartridge into a drive that is not WORM capable causes the cartridge to be treated as an unsupported medium. The drive will report a media Error Code 7. Upgrading the drive firmware to the correct code level will resolve the problem.

---

## Cleaning Cartridge

With each library, a specially labeled LTO Ultrium Cleaning Cartridge is supplied to clean the drive head. The drive itself determines when a head needs to be cleaned. It alerts you by lighting the "Clean Drive" (amber LED) above the library Operator Control Panel. To clean the head manually, insert a cleaning cartridge into the tape load compartment (see "Inserting the Cleaning Cartridge" on page 4-37). The drive performs the cleaning automatically. When the cleaning is finished, the drive ejects the cartridge, and the library turns the "Clean Drive" LED off. Some libraries have an Auto Clean function which, when enabled, will prompt the library to retrieve the cleaning cartridge that resides in the library, insert it in the drive that needs cleaning, clean the drive, then return the cleaning cartridge to its home slot.

**Note:** The drive will automatically eject an expired cleaning cartridge.

The Cleaning Cartridges are valid for 50 uses.

---

## Bar Code Label

A bar code label contains:

- A volume serial number (VOLSER) that is human-readable
- A bar code that the library can read

**Note:** The LTO Ultrium 5 Tape Drive does not require bar code labels, but you may choose to use labels for tape cartridge identification purposes.

When read by a library's bar code reader, the bar code identifies the cartridge's VOLSER to the library. The bar code also tells the library whether the cartridge is a data cartridge or cleaning cartridge. In addition, the bar code includes the two-character media-type identifier Lx, where x equals 1, 2, 3, 4, or 5. L identifies the cartridge as an LTO cartridge and the number represents the generation of cartridge for that cartridge type. Figure 6-3 on page 6-5 shows a sample bar code label for the LTO Ultrium Tape Cartridge.

Tape cartridges can be ordered with the labels included or with custom labels. The bar code for usage in LTO tape libraries must meet predefined specifications. They include (but are not limited to):

- Six or eight (the default) uppercase alphanumeric characters, where the last two characters must be L5, L4, L3, L2, or L1.
- Label and printing to be non-glossy
- Nominal narrow line or space width of 0.423 mm (0.017 in.)
- Wide to narrow ratio of 2.75:1
- Minimum bar length of 11.1 mm (0.44 in.)

*Table 6-3. Cartridges and VOLSERs compatible with the Ultrium Tape Drives*

Cartridges	VOLSER
Ultrium 5 Data Cartridge	xxxxxxL5

Table 6-3. Cartridges and VOLSERs compatible with the Ultrium Tape Drives (continued)

Cartridges	VOLSER
Ultrium 5 WORM Cartridge	xxxxxxLV
Ultrium 4 Data Cartridge	xxxxxxL4
Ultrium 4 WORM Cartridge	xxxxxxLU
Ultrium 3 Data Cartridge	xxxxxxL3
Ultrium 3 WORM Cartridge	xxxxxxLT
Ultrium 2 Data Cartridge	xxxxxxL2
Ultrium 1 Data Cartridge (READ ONLY)	xxxxxxL1
LTO Ultrium Cleaning Cartridge	CLNxxxLx
*An Ultrium 3 Tape Drive must have a minimum firmware level of 54xx for it to be compatible with the WORM cartridge.	

When attaching a bar code label to a tape cartridge, place the label only in the recessed label area (see **4** in Figure 6-1 on page 6-1). A label that extends outside of the recessed area can cause loading problems in the drive.

**Attention:** Do not place any type of mark on the white space at either end of the bar code. A mark in this area may prevent the library from reading the label.

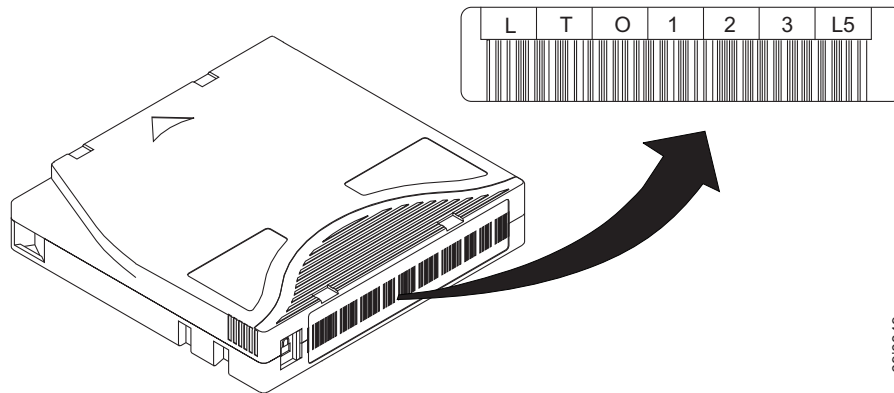

Figure 6-3. Sample bar code label on the LTO Ultrium 5 Tape Cartridge. The volume serial number (LTO123) and bar code are printed on the label.

## Guidelines for Using Bar Code Labels

Apply the following guidelines whenever using bar code labels:

- Do not reuse a label or reapply a used label over an existing label.
- Before you apply a new label, remove the old label by slowly pulling it at a right angle to the cartridge case.
- Use peel-clean labels that do not leave a residue after being removed. If there is glue residue on the cartridge, remove it by gently rubbing it with your finger. Do not use a sharp object, water, or a chemical to clean the label area.
- Examine the label before applying it to the cartridge. Do not use the label if it has voids or smears in the printed characters or bar code (a library's inventory operation will take much longer if the bar code label is not readable).
- Remove the label from the label sheet carefully. Do not stretch the label or cause the edges to curl.

- Position the label within the recessed label area (see **5** in Figure 6-1 on page 6-1).
- With light finger pressure, smooth the label so that no wrinkles or bubbles exist on its surface.
- Verify that the label is smooth and parallel, and has no roll-up or roll-over. The label must be flat to within 0.5 mm (0.02 in.) over the length of the label and have no folds, missing pieces, or smudges.
- Do not place other machine-readable labels on other surfaces of the cartridge. They may interfere with the ability of the drive to load the cartridge.

## Write-Protect Switch

The position of the write-protect switch on the tape cartridge (see **1**) determines whether you can write to the tape. If the switch is set to:

- The locked position  (solid red), data cannot be written to the tape.
- The unlocked position (black void), data can be written to the tape.

If possible, use your server's application software to write-protect your cartridges (rather than manually setting the write-protect switch). This allows the server's software to identify a cartridge that no longer contains current data and is eligible to become a scratch (blank) data cartridge. Do not write-protect scratch (blank) cartridges; the tape drive will not be able to write new data to them.

If you must manually set the write-protect switch, slide it left or right to the desired position.

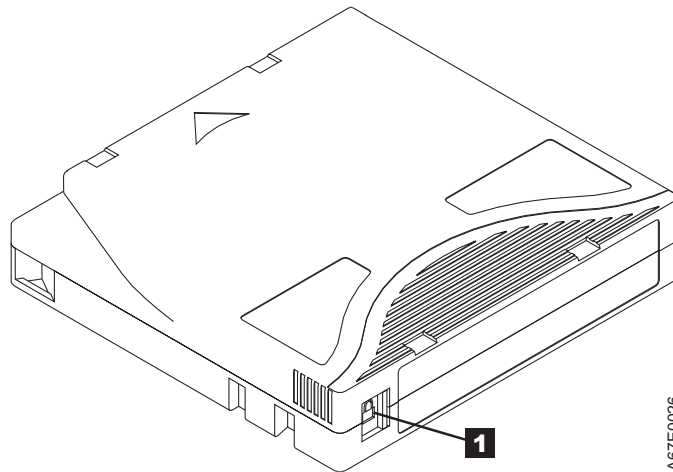

Figure 6-4. Setting the write-protect switch

Table 6-4. Location of the write-protect switch

<b>1</b>	Write-Protect Switch
----------	----------------------

---

## Handling the Cartridges

**Attention:** Do not insert a damaged tape cartridge into the drive. A damaged cartridge can interfere with the reliability of a drive and may void the warranties of the drive and the cartridge. Before inserting a tape cartridge, inspect the cartridge case, cartridge door, and write-protect switch for breaks.

Incorrect handling or an incorrect environment can damage cartridges or their magnetic tape. To avoid damage to your tape cartridges and to ensure the continued high reliability of your LTO Ultrium Tape Drives, use the following guidelines:

### Provide Training

- Post procedures that describe proper media handling in places where people gather.
- Ensure that anyone who handles tape has been properly trained in handling and shipping procedures. This includes operators, users, programmers, archival services, and shipping personnel.
- Ensure that any service or contract personnel who perform archiving are properly trained in media-handling procedures.
- Include media-handling procedures as part of any services contract.
- Define and make personnel aware of data recovery procedures.

### Ensure Proper Packaging

- When shipping a cartridge, use the original or better packaging.
- Always ship or store a cartridge in a jewel case.
- Use only a recommended shipping container that securely holds the cartridge in its jewel case during transportation.
- Never ship a cartridge in a commercial shipping envelope. Always place it in a box or package.
- If you ship the cartridge in a cardboard box or a box of a sturdy material, ensure the following:
  - Place the cartridge in polyethylene plastic wrap or bags to protect it from dust, moisture, and other contaminants.
  - Pack the cartridge snugly; do not allow it to move around.
  - Double-box the cartridge (place it inside a box, then place that box inside the shipping box) and add padding between the two boxes (see Figure 6-5 on page 6-8).



Figure 6-5. Double-boxing tape cartridges for shipping

## Provide Proper Acclimation and Environmental Conditions

- Before you use a tape cartridge, acclimate it to the operating environment for 24 hours or the time necessary to prevent condensation in the drive (the time will vary, depending on the environmental extremes to which the cartridge was exposed).
- Ensure that all surfaces of a cartridge are dry before inserting it.
- Do not expose the cartridge to moisture or direct sunlight.
- Do not expose recorded or blank cartridges to stray magnetic fields of greater than 100 oersteds (for example, terminals, motors, video equipment, X-ray equipment, or fields that exist near high-current cables or power supplies). Such exposure can cause the loss of recorded data or make the blank cartridge unusable.
- Maintain the conditions that are described in “Environmental and Shipping Specifications for Tape Cartridges” on page 6-9.

## Perform a Thorough Inspection

After purchasing a cartridge and before using it, perform the following steps:

- Inspect the cartridge's packaging to determine potential rough handling.
- When inspecting a cartridge, open only the cartridge door. Do not open any other part of the cartridge case. The upper and lower parts of the case are held together with screws; separating them destroys the usefulness of the cartridge.
- Inspect the cartridge for damage before using or storing it.
- Inspect the rear of the cartridge (the part that loads first into the tape load compartment) and ensure that there are no gaps in the seam of the cartridge case. If there are gaps in the seam (see Figure 6-6 on page 6-9), the leader pin may be dislodged.



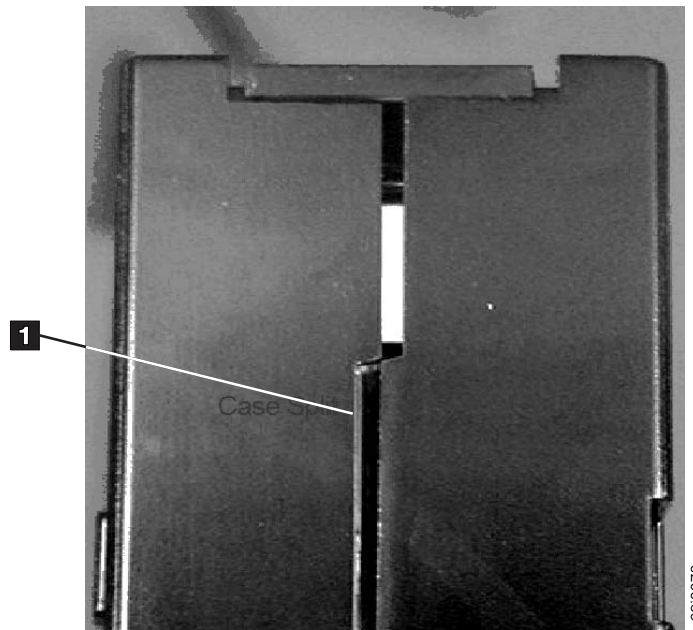

Figure 6-6. Checking for gaps in the seams of a cartridge

- Check that the leader pin is properly seated.
- If you suspect that the cartridge has been mishandled but it appears usable, copy any data onto a good cartridge immediately for possible data recovery. Discard the mishandled cartridge.
- Review handling and shipping procedures.

### Handle the Cartridge Carefully

- Do not drop the cartridge. If the cartridge drops, slide the cartridge door back and ensure that the leader pin is properly seated in the pin-retaining spring clips.
- Do not handle tape that is outside the cartridge. Handling the tape can damage the tape's surface or edges, which may interfere with read or write reliability. Pulling on tape that is outside the cartridge can damage the tape and the brake mechanism in the cartridge.
- Do not stack more than six cartridges.
- Do not degauss a cartridge that you intend to reuse. Degaussing makes the tape unusable.

---

## Environmental and Shipping Specifications for Tape Cartridges

Before you use a tape cartridge, acclimate it to the operating environment for 24 hours or the time necessary to prevent condensation in the drive (the time will vary, depending on the environmental extremes to which the cartridge was exposed).

The best storage container for the cartridges (until they are opened) is the original shipping container. The plastic wrapping prevents dirt from accumulating on the cartridges and partially protects them from humidity changes.

When you ship a cartridge, place it in its jewel case or in a sealed, moisture-proof bag to protect it from moisture, contaminants, and physical damage. Ship the

cartridge in a shipping container that has enough packing material to cushion the cartridge and prevent it from moving within the container.

Table 6-5 gives the environment for operating, storing, and shipping LTO Ultrium Tape Cartridges.

*Table 6-5. Environment for operating, storing, and shipping the LTO Ultrium Tape Cartridge*

Environmental Factor	Environmental Specifications			
	Operating	Operational Storage <sup>1</sup>	Archival Storage <sup>2</sup>	Shipping
Temperature	10 to 45°C(50 to 113°F)	16 to 32°C(61 to 90°F)	16 to 25°C(61 to 77°F)	-23 to 49°C(-9 to 120°F)
Relative humidity (non-condensing)	10 to 80%	20 to 80%	20 to 50%	5 to 80%
Maximum wet bulb temperature	26°C(79°F)	26°C(79°F)	26°C(79°F)	26°C(79°F)
<b>Note:</b>				
1. The short term or operational storage environment is for storage durations of up to six months.				
2. The long term or archival storage environment is for durations of six months up to ten years.				

## Chapter 7. Troubleshooting

- The library consists of the following CRUs (Customer Replaceable Units):
  - Control Card (electronics, processor, memory, etc.)
  - Power Supply
  - Drive Sled (drive plus drive-to-library connectivity)
  - Cartridge Magazines
- **Service Spare:**
  - Library Enclosure (accessor, Operator control panel display, etc.)
- **Other possible Replacement Parts are:**
  - Data Cartridges
  - Cables/Terminator

**Important:** Before replacing any CRU and after finding the problem and performing any listed actions listed in the Troubleshooting Table below, be sure to review the “Procedures for Isolating CRU Problems” on page 7-7 to help confirm the failing CRU.

The following table is the starting point for all service issues. Find the reason which closest resembles the problem you are experiencing and perform the listed action. If you are unable to correct the problem, create a prioritized list of replacement parts required. Select only one CRU at a time starting with the most likely based on the “Procedures for Isolating CRU Problems” on page 7-7 and/or the error code listing.

After correcting the problem, run Library Verify (Operator Control Panel: **Service → Library Verify**) to ensure that all library components are functioning properly before resuming normal library operations.

Table 7-1. Troubleshooting table

Problem	Solution
<b>INSTALLATION/CONFIGURATION</b>	
Unable to configure 3 logical libraries with 3 drives (2 half height drives and 1 full height drive) installed.	The 2 half height drives must be in drive positions 1 and 2 (the lowest drive positions in the library) and the full height drive must be in the remaining drive position. For additional information, refer to Appendix A, “SCSI Element Types, SCSI Addresses, and Physical Configurations,” on page A-1.
Installation and Configuration	1. Refer to “Installation Problems” on page 7-6.
<b>POWER</b>	
Library does not power ON	1. Perform “Isolating a Power Supply Problem” on page 7-7.
The Operator Control Panel is blank or frozen	<ol style="list-style-type: none"> <li>1. Power cycle the library.</li> <li>2. If possible, log on to the Web User Interface and check the error log (<b>Service Library → View Logs</b>). Look up the error code and try to resolve (see Chapter 8, “Error Codes,” on page 8-1).</li> <li>3. Upgrade/reinstall the latest library firmware. To download the latest library firmware, visit <a href="http://www.support.dell.com">http://www.support.dell.com</a>.           <ul style="list-style-type: none"> <li>• If the problem is corrected, run Library Verify before resuming normal library operations. Refer to “Service: Library Verify” on page 5-30.</li> <li>• If the problem persists, refer to Dell technical support.</li> </ul> </li> </ol>

Table 7-1. Troubleshooting table (continued)

Problem	Solution
<b>ENCRYPTION</b>	
<p>Encryption Error: Displayed when the drive detects an error associated with an encryption operation - if the problem occurred while the tape drive was writing data to, or reading data from, tape</p>	<ol style="list-style-type: none"> <li>1. Check the host application to ensure the Encryption Key Manager (EKM) application is providing the correct encryption key. <ul style="list-style-type: none"> <li>• Refer to the “Drive Sense Data” on page C-6 returned for an encryption operation.</li> <li>• Retry the encryption operation after the EKM application problems have been resolved.</li> </ul> </li> <li>2. Check the operation of the tape drive by resetting the drive (Operator Control Panel: <b>Service</b> → <b>Service</b> → <b>Drive Power</b>) and running POST. <ul style="list-style-type: none"> <li>• Refer to the error code displayed on the Operator Control Panel if the drive resets and POST fails.</li> <li>• Retry the encryption operation if the drive reset and POST complete without errors.</li> </ul> </li> <li>3. Check the media. <ul style="list-style-type: none"> <li>• Ensure the correct media is being used. Data encryption is supported with LTO Ultrium 4 Data Cartridges only.</li> <li>• Retry the encryption operation with the tape cartridge in another encryption enabled drive. Replace the media if the problem repeats with the same tape cartridge in multiple drives. If the problem occurred while the tape drive was running POST or diagnostics, replace the drive. The error code clears with the first attempted write/read after the encryption key is changed, or when the drive is placed in maintenance mode.</li> </ul> </li> </ol>
<p>Encryption-related error is posted</p>	<p>Check the EKM application's error logs, device driver logs, tape library error logs, and tape drive error logs for entries that are related to encryption. See “Service Library: View Logs” on page 5-58, “Service Library: View Drive Logs” on page 5-59, Chapter 8, “Error Codes,” on page 8-1, and “Drive Sense Data” on page C-6.</p>
<p>Connection problem with the Dell Encryption Key Manager (EKM)</p>	<p>If you are using library-managed encryption, perform the Key Path Diagnostic (see “Service Library: Key Path Diagnostics” on page 5-61) if this feature is available. If the test fails, a problem could exist with the IP address, the Ethernet cable, or the EKM server. Perform the following:</p> <ol style="list-style-type: none"> <li>1. Check the Ethernet connection between the library and the EKM server.</li> <li>2. Check the TCP/IP configuration of the library and the server.</li> <li>3. Check that the EKM is correctly installed and configured, and that the EKM application is properly started (refer to your EKM documentation).</li> <li>4. Ensure that the tape drive is registered in the EKM (refer to your EKM documentation).</li> <li>5. Ensure that a default key label is defined in the EKM (refer to your EKM documentation).</li> </ol> <p>If you are using application-managed encryption, check your tape backup application documentation for a similar test.</p>
<b>ERROR CODES</b>	
<p>There is an error code in the error log.</p>	<p>Most library or drive errors will result in an error code or error message on the Operator Control Panel display. An error code history is maintained in the library or drive error log. See “Service Library: View Drive Logs” on page 5-59 for how to get the error log over the Operator Control Panel and “Service Library: View Logs” on page 5-58 to view logs using the Web User Interface.</p> <p>Look up the error code and try to resolve (see Chapter 8, “Error Codes,” on page 8-1 and/or Appendix C, “Sense Data,” on page C-1).</p>
<b>FRONT PANEL LEDs</b>	

Table 7-1. Troubleshooting table (continued)

Problem	Solution
Attention LED	<p>To determine why the Attention LED is turned ON, log in to the Web User Interface and select <b>Service Library</b> → <b>View Logs</b> → <b>Warning Trace</b>.</p> <p><b>Drive Sled Issues:</b></p> <ul style="list-style-type: none"> <li>• Refer to “Isolating Drive Sled Problems” on page 7-9.</li> <li>• Whenever there is a hardware configuration change such as drives being swapped with different form factors (i.e. HH to FH or FH to HH), a library configuration change is needed. Reconfiguring the library by reassigning the amount of logical libraries will clear this issue. Navigate to the Web User Interface <b>Configure Library</b> → <b>Logical Libraries</b> or to the Operator Control Panel's <b>Configure</b> → <b>Logical Libraries</b> section and reassign the logical libraries. If you do not want to change your logical library configuration, resubmit your current settings.</li> <li>• Restore factory defaults (Operator Control Panel: <b>Configure</b> → <b>Save/Restore</b> and select <b>Restore All</b>, or Web User Interface: <b>Configure Library</b> → <b>Save/Restore</b> and select <b>Restore</b>).</li> </ul> <p><b>Media Issues:</b></p> <ul style="list-style-type: none"> <li>• Avoid contamination by ensuring that the library is installed in a clean, contamination-free environment. Continue cleaning the tape drive as needed. Refer to “Choosing a Location” on page 4-1.</li> <li>• A cartridge should be acclimated for at least 24 hours before being used, particularly if it has been stored at a substantially different temperature or level of humidity than the library. Refer to “Provide Proper Acclimation and Environmental Conditions” on page 6-8.</li> <li>• Any cartridge that is suspected of being defective or contaminated should NOT be reused, in any drive.</li> </ul> <p><b>Power Supply or Fan Issues:</b></p> <p>Check the power supply (or redundant power supply) for failure, and also check any power supply fans. Replace any defective units. Refer to “System Status” on page 2-6 for a redundant power supply failure on a 4U library and “Isolating a Power Supply Problem” on page 7-7.</p>
Clean Drive LED	<ul style="list-style-type: none"> <li>• Ensure that you are using an Ultrium universal cleaning cartridge (see “Cleaning Cartridge” on page 6-4).</li> <li>• Ensure that the cleaning cartridge has not expired. A drive will automatically eject an expired cleaning cartridge. A cleaning cartridge is good for 50 cleans. If your cleaning cartridge has expired, order a new cleaning cartridge.</li> <li>• If the problem still exists, contact technical support.</li> </ul>
Error LED	<p>If the Error LED remains ON after completing any user action listed for the error code in Chapter 8, “Error Codes,” on page 8-1, run Library verify (Operator Control Panel: <b>Service</b> → <b>Library Verify</b>).</p> <ul style="list-style-type: none"> <li>• If the test passes, the Error LED will turn OFF.</li> <li>• If the test fails, cycle library power to turn the Error LED OFF.</li> </ul> <p>To check the library error log, log on to the Web User Interface and click <b>Service Library</b>, then <b>View Logs</b>. If the Operator Control Panel displays <b>WARNING: Unit Busy</b>, click <b>OK</b> to turn the error LED OFF.</p>
<b>FIRMWARE</b>	

Table 7-1. Troubleshooting table (continued)

Problem	Solution
Determining current firmware levels	<p>Many problems can be resolved by a firmware upgrade. Ensure that both the library and drive firmware are at the latest levels available.</p> <ul style="list-style-type: none"> <li>• Library firmware: <b>Monitor</b> → <b>Library</b> → <b>Identity</b> → <b>Version</b></li> <li>• Drive firmware: <b>Monitor</b> → <b>Drives</b> → <b>Identity (select a drive)</b> → <b>Firmware Rev</b></li> </ul>
Update library firmware	Refer to “Service Library: Upgrade Firmware” on page 5-62.
Update drive firmware	Refer to “Service: Service (Drives)” on page 5-31 or “Service Library: Upgrade Firmware” on page 5-62.
<b>CARTRIDGE MOVEMENT PROBLEMS</b>	
Cartridge placement problems	<p>Magazine slot prism fiducials NOT seated properly can result in gripper or slider error codes due to the fiducial interfering with the back edge of the cartridge. Release and pull magazines out of the library for inspection. To release the magazines using the Operator Control Panel, navigate to <b>Control</b> → <b>Magazine</b> and select <b>Left</b> or <b>Right</b>. To release the magazines using the Web User Interface, navigate to <b>Manage Library</b> → <b>Release Magazines</b>.</p> <p>Inspect the light pipe fiducials on each slot of the magazine for proper seating.</p>
Cartridge will not eject from drive	<ol style="list-style-type: none"> <li>1. Allow the drive to complete all operations. This may take as long as 1 hour if you reset or cycle power on the library while the cartridge is positioned at the physical end of the media.</li> <li>2. Ensure that the backup software is not reserving the slot or preventing the drive from ejecting the cartridge. The backup software needs to cancel the reservation and any hold it has on the drive. Temporarily disconnecting the library from the host server and power cycling eliminates the host and its software as a problem source.</li> <li>3. If the problem still exists, contact technical support.</li> </ol>
Cartridge can not be removed from storage slot	See “Removing Cartridges from Magazine Slots” on page 9-1.
<b>MEDIA</b>	
Cleaning or data cartridge incompatible with drive.	Ensure that you are using data and cleaning cartridges that are compatible with the drive and model of your library. The library automatically unloads incompatible cartridges and the Media Attention LED flashes. Export the media in order to clear the state. Refer to “Cartridge Compatibility” on page 6-2.
Cannot write to or read from tape.	<ol style="list-style-type: none"> <li>1. Ensure that the cartridge write-protect switch is in the write enabled position (see “Write-Protect Switch” on page 6-6).</li> <li>2. Ensure that you have the appropriate data cartridge for your library model (see “Cartridge Compatibility” on page 6-2).</li> <li>3. Ensure that you are using an Ultrium cartridge that has <u>not</u> been degaussed. Do not degauss Ultrium cartridges.</li> <li>4. Ensure that the cartridge has not been exposed to harsh environmental or electrical conditions and is not physically damaged in any way. Refer to “Provide Proper Acclimation and Environmental Conditions” on page 6-8 and “Perform a Thorough Inspection” on page 6-8.</li> <li>5. Many backup applications do not read or write to cartridges that were created using a different backup application. In this case, you may have to perform an erase, reformat, or label replacement operation on the cartridge.</li> <li>6. Ensure that you understand any data protection or overwrite protection schemes that your backup application may be using, which could prevent you from writing to a given cartridge.</li> <li>7. Retry the operation with a different, known good cartridge.</li> <li>8. Clean the drive. See “Service Library: Clean Drive” on page 5-57.</li> </ol>

Table 7-1. Troubleshooting table (continued)

<b>Problem</b>	<b>Solution</b>
Cartridge VOLSER is reported as "unknown"	<p>Probable cause: cartridge with no label or damaged label.</p> <p>Ensure that cartridge is properly labelled. If cartridge is properly labelled, unload the cartridge from drive and perform an inventory (OCP: <b>Control</b> → <b>Re-Inventory</b>; Web: <b>Manage Library</b> → <b>Perform Inventory</b>). If VOLSER is again reported as "Unknown", run Library Verify (<b>Service</b> → <b>Library Verify</b>).</p>
<b>DRIVE ID (SCSI, SAS, OR FIBRE CHANNEL LOOP)</b>	
Changed drive ID, but the host server does not recognize the new ID	<ol style="list-style-type: none"> <li>1. Ensure that all devices on the same bus/network have unique ID numbers.</li> <li>2. Ensure that you cycle power on the library after changing the ID.</li> <li>3. Reboot the host server.</li> </ol>
Tape library performance: The library is not efficiently backing up data	<ol style="list-style-type: none"> <li>1. Check the network bandwidth from the host computer. If you are backing up data over a network, consider comparing to a local-only backup.</li> <li>2. Ensure that the library and tape drive are on their own SCSI bus and not daisy-chained to another tape drive or to the hard drive being backed up.</li> <li>3. Ensure that the library is connected to a LVDS SCSI bus and there are no single-ended (SE) devices on the same bus, because this will cause the entire bus to negotiate down to SE speed.</li> <li>4. Use an Ultra160 SCSI bus and high-quality cabling with the library.</li> </ol>
<b>CUSTOMER REPLACEABLE UNITS (CRU) AND SERVICE SPARES</b>	
Drive Sled	See "Isolating Drive Sled Problems" on page 7-9.
Power Supply	See "System Status" on page 2-6 and "Isolating a Power Supply Problem" on page 7-7.
Library Controller Card	See "Isolating a Library Controller Card vs. Accessor Enclosure Problem" on page 7-10.
Library Enclosure (Service Spare)	See "Isolating a Library Controller Card vs. Accessor Enclosure Problem" on page 7-10.
<b>ITDT</b>	
Performance Test duration varies	<p>Items affecting the duration of the test are:</p> <ul style="list-style-type: none"> <li>• The level of adapter device driver</li> <li>• Your adapter model and type</li> </ul>
<b>OTHER PROBLEMS</b>	
Web User Interface problems	See "Isolating Web User Interface Problems" on page 7-11.
Bar code scanner problems	See "Isolating Accessor Scanner Problems" on page 7-11.
Host Attachment Interface problems	See "Isolating Host Attachment Interface Problems" on page 7-12
Need help with a library password	Contact technical support.
Key path diagnostic not working	This diagnostic is available with library firmware level greater than 6.xx. Refer to "Verifying/Updating Firmware" on page 4-18 to determine the level of firmware on your library. If necessary, visit <a href="http://support.dell.com">http://support.dell.com</a> to download the latest levels of firmware for your library.
Auto Clean status displayed as "Chk Media/Rsvd Slot?" on the Web User Interface System Status screen.	If Auto Clean is enabled and a cleaning cartridge is not present, or if a cleaning cartridge is present but not in the reserved slot, Auto Clean status will show "Chk Media/Rsvd Slot?" and Status will show a green check mark and the words "Media Attention."

---

## Installation Problems

Problems encountered during the installation of the library are usually caused by improper SCSI bus configuration, application software configuration errors, or an incorrectly configured operating system. If the application software that you are using is not communicating with the library after installation, check the following:

- **Picker Ship Lock Key:**

Ensure that the Picker Ship Lock Key on the top cover has been removed **before** powering on the library.

- **Drive/Library SCSI or Loop ID:**

Ensure that the SCSI ID of the Drive/Library (or SAS or Fibre Channel Loop ID) is correct and not the same as other devices that may be on the same bus.

- **Host Bus Adapter (HBA) Compatibility:**

Ensure that the library is compatible with the HBA. For best performance, the HBA used for this library should be SCSI-3 LVDS. Pay particular attention to any steps describing settings of various jumpers and/or switches.

- **HBA LUN 0/1 Support:**

A single ID will address both drive and library since the drive is LUN 0 and the library is LUN 1. These models require an HBA that supports LUN scanning which must be enabled at the HBA.

- **Cable Connections:**

Ensure that there are no bent pins on cables and that all connections are securely fastened.

- **Fibre Channel Tape Support:**

Make sure that Fibre Channel Tape Support is enabled on the HBA if you are installing a library with a Fibre Channel drive.

- **SCSI Cable Length:**

Ensure that the maximum cable length is not over 25 meters (82 ft.) for a single device on the bus or 12 meters (40 ft.) for multiple devices. Internal SCSI length within the library accounts for 2 ft.

- **SCSI Termination:**

Verify proper termination on both ends of the SCSI bus.

- **Backup Application Installation:**

Refer to the documentation included with your backup application software instructions on how to verify proper installation.

- **Device Driver Installation:**

Make sure that the proper device driver, if applicable, is installed for the library.

**Note:** Many backup applications use their own drivers for the library and drive. Before installing a driver, make sure it will not be in conflict with the software. Contact your Backup Application vendor for this information.

---

## Library Recovery Problem Determination

The 2U and 4U library firmware will generally retry failed operations up to three times before posting a failure to complete the operation, or, in some situations, proceeding with an operation that can be completed in an alternative manner. Of course, if the operation is successful within the allotted retry count, the appropriate retry counter is updated and recorded in the retry log and the next library operation will commence.



For example, failure to pick or place a cartridge from or to a designated cell or drive location after exhausting the retry count will result in a failed operation with the appropriate error code. However, failure to detect a particular cell location by sensing the prism fiducial located on the cell shelf because it is missing or damaged will eventually result in the cell location being located by the gripper, bar code reader and positional emitter pulse count after the prism detection retry count is exhausted. If several prisms are missing or damaged or if the accessor prism sensor/emitter is inoperable, initialization and/or inventory functions can take a prolonged amount of time to complete due to the lengthy retry recovery procedure.

If the library is taking an extended amount of time to initialize, to perform an inventory or even move a cartridge within the library, the magazines prism integrity should be verified prior to exchanging a library component. This situation can be noted by the ACTIVITY line on the Operator Panel posting Recovery. Prism integrity verification can be done by releasing the magazines and inspecting the cell prisms. Normal initialization or inventory time for a 2U library once the picker mechanism starts its operation should be approximately 1 to 2 minutes. For a 4U library, 2 to 3 minutes. A single missing or damaged prism can add 1 to 2 minutes. If the accessor tray sensor/emitter is inoperable, or several prisms are missing or damaged, initialization or inventory could exceed 30 minutes or longer. Refer to Troubleshooting table "Cartridge Movement Problems".

---

## Procedures for Isolating CRU Problems

### Isolating a Power Supply Problem

**Note:** Not all power supplies have LEDs. The original power supply for the 2U library did not have LEDs though any power supplies replaced will likely have LEDs. The 4U library has power supplies with LEDs.

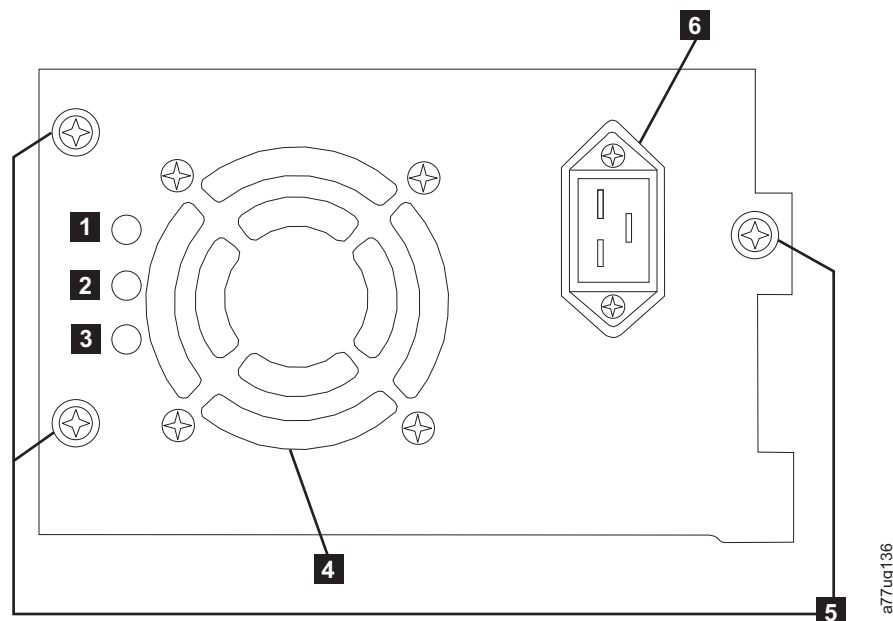

Figure 7-1. A 250w power supply with LEDs

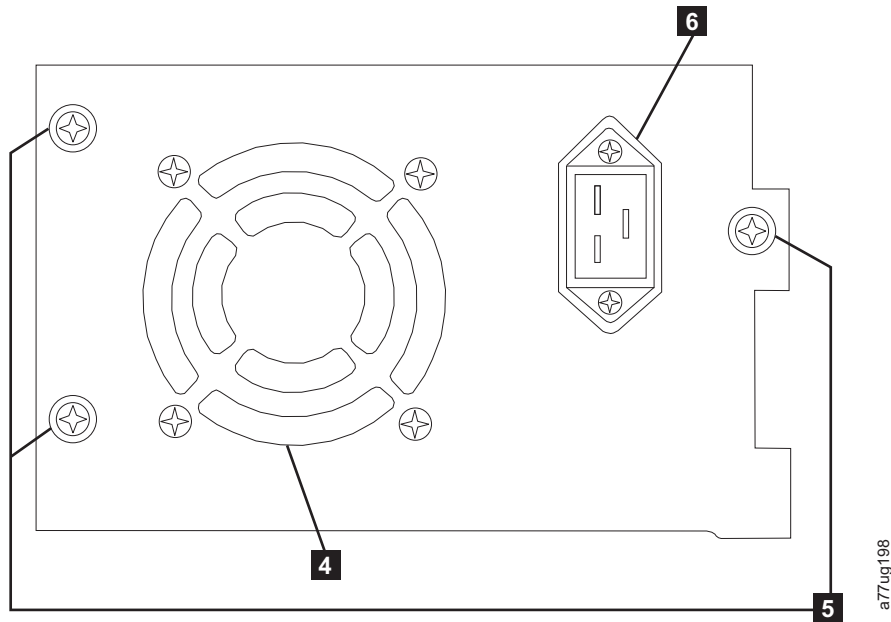

Figure 7-2. A 80w power supply without LEDs

Table 7-2. Power Supply LED Meanings

<b>1</b>	If the blue LED is lit, AC voltage is available.
<b>2</b>	If the amber LED is lit, there is a possible fan problem or other power supply issue. The power supply will need replacement.
<b>3</b>	If the green LED is lit, DC power is OK and active.
<b>4</b>	Cooling Fan Grill
<b>5</b>	Thumb Screws
<b>6</b>	Power Receptacle

If the Library does not power on:

1. With library power OFF and the power cord unplugged, loosen the three thumb screws ( **5** ), grasp two of the thumb screws, pull the power supply out half way, reseal the power supply, and tighten the three thumb screws.
2. Ensure the power cord is plugged in at the power supply ( **6** ) and at the electrical outlet, then turn library power ON.
  - a. For power supplies with LED's, the "Blue" LED will be lit if AC power is good.
  - b. If your power supply does not have LED's, feel for air flowing out of the cooling fan grill on the rear of the library ( **4** ). AC is good if air is flowing from the cooling fan grill.
3. If power appears to be missing
  - a. Plug the power cord into another electrical outlet.
  - b. If power is still missing, plug another device into the outlet to test.
  - c. If the outlet tests OK, try another power cord with the library.
4. For power supplies with LED's, if the "Amber" LED is lit, replace the power supply (refer to "Replacing a Power Supply" on page 10-10).

5. If your power supply has no LED's, and you have verified that the electrical outlet works properly, but the power supply is still failing, replace it (refer to "Replacing a Power Supply" on page 10-10).
6. If the power supply seems to be delivering power to the library (Operator Control Panel and front panel LED's may be functioning); however, air does not flow from the power supply cooling fan grill on the rear of the library, replace the power supply (refer to "Replacing a Power Supply" on page 10-10).
7. If the power supply seems to be delivering power to the library (Operator Control Panel and front panel LED's may be functioning), and air is flowing from the power supply cooling fan grill on the rear of the library, observe the "Green" LED (lowest of the three). If it is lit, the power supply is OK.

**Note:** If your library has -04 level redundant power supplies (see label on top of power supply), it is normal for the one in "Standby" mode to turn its "Green" LED off. You can test this power supply by pulling the power connector from the other "Active" power supply. The power supply that was in "Standby" mode will now become "Active", and its "Green" LED should light. If it doesn't, replace it (refer to "Replacing a Power Supply" on page 10-10).

If your library has -05 level redundant power supplies, the "Green" LED will be ON on both power supplies. If both "Green" LEDs are not ON, replace the failed power supply (refer to "Replacing a Power Supply" on page 10-10).

8. If the "Green" LED is not lit, and it is the only one in the Library, replace it (refer to "Replacing a Power Supply" on page 10-10).

## Isolating Drive Sled Problems

Prior to replacing a drive sled CRU, verify that the following activities have been performed:

1. BEFORE POWERING OFF THE LIBRARY, write the drive dump to flash. It is important to preserve the drive dump on the drive for analysis by Technical Support.

**Note:** If you are instructed by Dell Technical Support to copy the drive dump to your host computer, use one of the following methods:

- Web User Interface: Refer to "Service Library: Save Drive Dump" on page 5-60.
- ITDT: Refer to "Using the ITDT Firmware Update, Dump Retrieval and Drive Test Tool " on page 9-4.

2. Ensure that the drive firmware is at the latest level. To determine current library and drive firmware version using the Operator Control Panel:

- Library firmware: **Monitor** → **Library** → **Identity**
- Drive firmware: **Monitor** → **Drives** → **Identity (select a drive)** Drive firmware is identified in the **FW Rev** field.

3. Try reseating the drive sled.

**Note:** The drive sled is hot-pluggable so it is not necessary to power off the library. See "Removing/Installing/Adding a Tape Drive Sled" on page 10-3.

4. Cycle power to the library.

5. If air does not flow from the drive sled cooling fan grill on the rear of the library, replace the drive sled CRU. Several library error codes also point to cooling problems. See “Removing/Installing/Adding a Tape Drive Sled” on page 10-3.
6. If the drive is experiencing permanent or temporary errors or if the amber Clean LED is lit on the front panel of the library, select Clean Drive from the Operator Control Panel Service Menu (**Service** → **Service** → **Clean Drive**) and clean the drive. Use only an approved cleaning cartridge (see “Cleaning Cartridge” on page 6-4).
7. Run the **Library Verify Diagnostic** which includes a drive performance Read/Write test. Be sure to use a known good scratch or blank data cartridge.
  - If the drive test fails, replace the drive sled CRU (refer to “Removing/Installing/Adding a Tape Drive Sled” on page 10-3).
8. If the drive passes all the tests, inspect the media to ensure the media is compatible with the drive and not causing drive errors. Refer to Chapter 6, “Using Ultrium Media,” on page 6-1.

## Isolating a Library Controller Card vs. Accessor Enclosure Problem

1. If possible, ensure that the library firmware is at the latest level, check the current library firmware level using the Operator Control Panel (**Monitor** → **Library** → **Identity** → **Version**) or the Web User Interface (**Monitor Library** → **Library Identity**), then.
2. Observe the LED on the Library Controller Card.
  - LED On solid - LCC failed or in a hang condition.
  - LED Off - LCC not fully inserted, or LCC failed, or library not connected to power source, or Power Supply defect.
  - LED flashing (1 flash per second) - normal operation
  - LED flashing (slower than once per second) - normal operation
  - LED flashing (faster than once per second) - LCC failed
3. With library power OFF, loosen the two thumb screws which secure the controller card to the library enclosure and slide it out.
  - Inspect the card for any broken components or other anomalies.
  - If the card appears to have no abnormalities, reseal the card back in the library, tighten the thumb screws, and turn library power ON.
4. If both the Operator Control Panel and Web User interfaces are inoperable or frozen and the latest firmware has been installed, the controller card CRU electronics is the most likely failure. If only the Web User Interface has failed, please see “Isolating Web User Interface Problems” on page 7-11 before replacing any CRUs.
5. If a control card error code has been obtained and reseating, power cycling, and updating the library firmware did not fix the problem, the controller card CRU is the most likely failing CRU (refer to “Replacing a Library Controller Card” on page 10-11).
6. If the error code indicates an accessor type error (slider, elevator, sled, etc.), release and remove both magazines (see “Control: Magazine” on page 5-17, “Manage Library: Release Magazine” on page 5-43, or “Releasing the Magazines Manually” on page 9-1) and observe the accessor path for any obvious obstruction or problems. Resolve any observed problem if possible. Execute a Library System Test. See “Service Library: Perform Diagnostics” on page 5-60

page 5-60 for the web or “Service: Run Tests” on page 5-31 for the OCP If the problem is persistent, contact Dell technical support.

7. If the library is taking an extended amount of time in recovery to complete initialization, perform an inventory, or executing a cartridge movement within the library, and, after finding the magazine cell fiducials to be present with no visible damage and correctly installed, suspect the sensor/emitter on the accessor mechanism to be inoperable. Execute a Library System Test. See “Service Library: Perform Diagnostics” on page 5-60 for the web or “Service: Run Tests” on page 5-31 for the OCP If the problem is persistent, contact Dell technical support.

## Isolating Web User Interface Problems

If the Web User Interface is not functioning at all or if it is intermittently functioning, review the following steps to ensure that it is properly configured, or, to help determine which CRU or part needs to be replaced. The complete Web User Interface electronics reside on the library controller card CRU.

1. Ensure that the ethernet cable is securely plugged in the rear of the library at the ethernet port. See **7** on the “Rear Panel” on page 1-3.
2. Ensure that the correct IP, Netmask, and Gateway addresses are keyed into the network parameters. From the Operator Control Panel, navigate to **Configure** → **Network**.
3. Ensure that the correct IP address is being used on the web browser. If you get a security certificate alert when logging in to the Web User Interface, you can install the certificate or allow an exception (depending on the internet browser you are using). Even though with some browsers you will still receive a security certificate warning/error each time you log in to the Web User Interface, your transmission is secure. SSL is enabled when the URL to your library begins with **https://** and some browsers will show a lock.
4. If the ethernet connection is a direct connection between the PC and the library, a special "crossover" ethernet cable needs to be used.

**Note:** On newer PCs, either straight through or crossover ethernet cables may be used since the crossover requirement is provided internally.

5. Check the ethernet cable carefully (or try another cable) and, if the cable is connected to a network hub or switch, try a different port.
6. If the Web User Interface is still malfunctioning, replace the Library Controller Card CRU (refer to “Replacing a Library Controller Card” on page 10-11).

## Isolating Accessor Scanner Problems

If the server has reported inventory problems relating to inability to read bar code labels, or, if some or all of the cartridge labels are not being displayed on the Web User Interface, use the following procedure to determine if the scanner (library enclosure CRU) needs to be replaced.

1. Ensure that a supported bar code label (or labels) are being used.
2. With library power OFF, reseal the library controller card CRU (refer to “Replacing a Library Controller Card” on page 10-11), and then switch library power ON.
3. Perform a re-inventory via the Operator Control Panel (**Control** → **Re-Inventory**) and view the inventory via the Web User Interface (**Monitor Library** → **Inventory**) to determine if the labels are now being read.

4. If the labels are still not being read properly, please contact Dell technical support.

## Isolating Host Attachment Interface Problems

After successfully exercising "Isolating Drive Sled Problems", and more specifically the "Library Verify" diagnostic on the Operator Control Panel (**Service** → **Library Verify**) which includes a drive (or drives) read/write diagnostic, the following procedures are suggested to help isolate the failure to properly establish connectivity to the Host Bus Adapter (HBA).

1. Use the utility, ITDT, to evaluate connectivity from the HBA through the cabling to the drive (or drives). ITDT does not require separate device drivers, thus the Operating System has the ability to scan and find all the LTO devices that are attached. If ITDT cannot successfully locate the LTO drive, suspect cabling or HBA problems, and skip step 2. If ITDT successfully located the LTO drive, proceed to step 2. See "Using the ITDT Firmware Update, Dump Retrieval and Drive Test Tool " on page 9-4 for a brief description of ITDT and instructions on how to download the tool from the web.
2. If ITDT successfully locates the LTO device(s), verify that the correct application device drivers and backup application software is properly installed.
3. Ensure that all the required or latest available Operating System files and/or updates (dll's, PTF's, etc.) have been installed and applied.

---

## Identifying a Suspect Cartridge

The amber **Attention** LED will be lit on the front panel of the library when there has been a failure that indicates a piece of media is bad, marginal, or invalid. It will be cleared when all invalid cartridges have been exported from the library.

**Note:** The amber LED may also be lit because a power supply, or a power supply fan is failing. Refer to "Isolating a Power Supply Problem" on page 7-7.

1. Identify the media using the Web User Interface (**Monitor Library** → **Inventory**). Expand the cartridge details for each magazine and look for media status in the **Attn** column of the inventory table.
2. Make note of the cartridge location (Slot #) and VOLSER (Label) in the inventory table.
3. To remove the cartridge from the library:
  - a. Using the web, select **Manage Library** → **Move Media**. If the cartridge is not in an I/O Station slot, move the cartridge to an I/O Station slot.
  - b. Using the OCP, select **Control** → **Open I/O Station**.
4. Remove cartridge. If cartridge was reported as **Bad**, properly dispose the cartridge.
5. Close the I/O Station. If the amber LED was lit because of bad media, the **Attention** LED will turn OFF. If the amber LED is still on, check the power supply or the power supply fans. See "Isolating a Power Supply Problem" on page 7-7.

---

## Chapter 8. Error Codes

If an error occurs during operation of the library, the library stops the current operation and displays an error code on the LCD screen. Unless otherwise noted in “Error Codes” on page 8-2, try to resolve the error by cycling power to the library and retrying the last operation. If the error persists, contact technical support.

### Example Error Code

EVENT -6

8D 07

Where:

- -6 indicates the position in sequence list, 0 being the most recent.
- 8D 07 indicates the error. (code 8D = sled blocked,).

The event log with the library also includes a date stamp for each event. Press SELECT to display the associated time stamp in the following format:

yy.mm.dd hh:mm:ss:HH

Where:

- yy is the year
- mm is the month
- dd is the current day
- hh is hours
- mm is minutes
- ss is seconds
- HH is 1/100 second

The time stamp is set to zero at system start.

A description of each error code and possible solution is provided in “Error Codes” on page 8-2.

### Preparing to Resolve an Error Code

1. Record the error information that is displayed on the Operator Control Panel display or Web User Interface screen.
2. If possible, cycle library power and retry operation.
  - If the error reoccurs, refer to “Error Codes” on page 8-2 for information on resolving the error.
  - If the error does not reoccur, run Library Verify before continuing with normal library operation.

Complete the steps in “Preparing to Resolve an Error Code” before completing the User Action listed in “Error Codes” on page 8-2.

## Error Codes

Errors described in this section are hard errors. If such an error occurs the library stops all operations and the Error LED starts blinking. An appropriate message will be posted on the Operator Control Panel and the Web User Interface. These errors are also reported via email notification, if enabled. To enable email notifications, refer to “Configure Library: Email Notification” on page 5-55.

Table 8-1. Main Error Codes

Error Code	Description	User Action
80	Bar code reader Error, cannot initialize BCR	Error Code 80 01 may be posted if the library has a BCR (Bar Code Reader) that requires a minimum level of library firmware. Update the library firmware to 9.00 or higher. If the problem still exists, follow the procedure below. Refer to “Isolating a Library Controller Card vs. Accessor Enclosure Problem” on page 7-10. Possible Replacement CRUs: <ul style="list-style-type: none"> <li>• Primary: Library Enclosure</li> <li>• Secondary: Library Controller Card</li> </ul>
81	Bar code reader Error, no response from BCR	
82	EEPROM (Electrically Erasable Programmable Read-Only Memory ) Error, no response from EEPROM (located on accessor controller)	
83	Accessor controller generic problem	
84	Setting of gripper motor parameters failed	
85	Setting of slider motor parameters failed	
86	Setting of elevator motor parameters failed	
87	Setting of rotation motor parameters failed	
88	Setting of sled motor parameters failed	1. If this is the first time the library has been powered ON or if it has been moved to a new location, ensure that the shipping lock has been removed. The lock is located on the top of the library (see “Removing and Storing the Shipping Lock” on page 4-4). 2. Refer to “Isolating a Library Controller Card vs. Accessor Enclosure Problem” on page 7-10. Possible Replacement CRUs: <ul style="list-style-type: none"> <li>• Primary: Library Enclosure</li> <li>• Secondary: Library Controller Card</li> </ul>
89	Gripper blocked	
8A	Slider blocked	
8B	Elevator blocked	
8C	Rotation blocked	
8D	Sled blocked	



Table 8-1. Main Error Codes (continued)

Error Code	Description	User Action	
8E	Cannot find gripper block within the expected range	<p>Refer to “Isolating a Library Controller Card vs. Accessor Enclosure Problem” on page 7-10. Possible Replacement CRUs:</p> <ul style="list-style-type: none"> <li>• Primary: Library Enclosure</li> <li>• Secondary: Library Controller Card</li> </ul>	
8F	Cannot find slider block within the expected range		
90	Cannot find elevator block within the expected range		
91	Cannot find rotation block within the expected range		
92	Cannot find sled block within the expected range		
93	Gripper outside range, Gripper has reached a position beyond the expected range		
94	Slider outside range, Slider has reached a position beyond the expected range		
95	Elevator outside range, Elevator has reached a position beyond the expected range		
96	Rotation outside range, Rotation has reached a position beyond the expected range		
97	Sled outside range, Sled has reached a position beyond the expected range		
98	Cartridge present sensor not found		
99	Slider home sensor not found		
9A	Rotation home sensor not found		
9B	Sled position sensor (fiducial sensor) not found		
9C	Gripper range out of specification		
9D	Slider range out of specification		
9E	Elevator range out of specification		
9F	Rotation range out of specification		
A0	Sled range out of specification		
A1	Open I/O Station (Import/Export Element) failed		
A2	Error during elevator locking		
A6	No elevator home sensor found		
B0	Robotic controller response timeout. A command did not complete in the required amount of time.		
B1	NACK (not acknowledged) received from robotic controller		
B2	Accessor controller communication failed		
B3	Accessor controller urgent stop due to a released magazine		<ol style="list-style-type: none"> <li>1. Verify that the left and right magazines are completely inserted, then retry operation.</li> <li>2. Refer to “Isolating a Library Controller Card vs. Accessor Enclosure Problem” on page 7-10. Possible Replacement CRUs: <ul style="list-style-type: none"> <li>• Primary: Library Enclosure</li> <li>• Secondary: Library Controller Card</li> </ul> </li> </ol>
B4	Cartridge did not transport completely		
B5	Accessor controller does not respond on command		

Table 8-1. Main Error Codes (continued)

Error Code	Description	User Action
C0	Network initialization failed	<ol style="list-style-type: none"> <li>1. Refer to “Isolating Web User Interface Problems” on page 7-11.</li> <li>2. If the error recurs, contact technical support.</li> </ol>
C1	Telnet Interface initialization failed	
C2	Websserver initialization failed	
C6	Ping command did not reach target	
C7	Cannot Upgrade from USB	Not supported
C8	Cannot Upgrade from FTP	<ol style="list-style-type: none"> <li>1. Retry the Firmware upgrade.</li> <li>2. If the error recurs, contact technical support.</li> </ol>
C9	Cannot Upgrade Robotic from Flash	
D0	ROM error. ROM checksum incorrect	<p>Refer to “Isolating a Library Controller Card vs. Accessor Enclosure Problem” on page 7-10. Possible Replacement CRUs:</p> <ul style="list-style-type: none"> <li>• Primary: Library Controller Card</li> <li>• Secondary: Library Enclosure</li> </ul> <p>*D7 - Fatal System error can occur due to an over-temperature condition. Ensure the environment meets the Environmental Specifications (refer to “Environmental Specifications” on page 1-13).</p> <p>**If you receive a D8 error while restoring your library configuration from the OCP or Web UI, verify that your file extension is <b>.dbb</b>. If the extension is correct, your file may have been corrupted during the save. Reconfigure, then save your library configuration.</p> <p><b>Note:</b> Configuration files saved with one version of library firmware may not be compatible with other versions of firmware. It is recommended to save a configuration file each time the library firmware is upgraded. Restore the library using a configuration file that was saved with the same version of firmware currently installed in the library.</p>
D1	RAM error. Power on Self Test ( POST ) has failed,	
D2	NVRAM (Non-Volatile Random Access Memory) error. Read/Write operation to NVRAM has failed	
D3	CTC (Channel to Channel ) Error. Timer unit has failed during POST.	
D4	UART (Universal Asynchronous Receiver Transmitter ) Error. Frame overrun or Parity Error on serial Interface.	
D5	Display Error Communication to display failed	
D6	Memory Error, Stack and heap overflow.	
D7	Fatal system error*	
D8	Data base error**	
D9	No SCSI IC detected	
DA	While running the Library Verify Test, the bar code reader read different bar code data for the same customer-supplied scratch cartridge label.	<ol style="list-style-type: none"> <li>1. Check the barcode label on the scratch cartridge and run the Library Verify test again..</li> <li>2. If the error recurs, contact technical support.</li> </ol>
DB	Warning Event! See Table 8-3 on page 8-11	
DC	I <sup>2</sup> C Bus Failure	<ol style="list-style-type: none"> <li>1. Retry the operation..</li> <li>2. After several occurrences, contact technical support.</li> </ol>

Table 8-1. Main Error Codes (continued)

Error Code	Description	User Action
DD	Warning Event! See Table 8-3 on page 8-11	
DE	Warning Event! See Table 8-3 on page 8-11	
DF	Warning Event! See Table 8-3 on page 8-11	
E0	Incompatible magazine detected	<ol style="list-style-type: none"> <li>1. Remove magazine from library.</li> <li>2. Insert magazine in library. If error recurs, contact technical support.</li> </ol>
E2	New hardware found. Library firmware upgrade required.	Upgrade library firmware to the latest version.
EB	Power supply health check failed due to a power supply failure.	Refer to "Isolating a Power Supply Problem" on page 7-7
F0	<p>Drive Over temperature Condition</p> <p>The subcode indicates which drive is affected.</p> <p><u>Example:</u></p> <p>Subcode 02: drive #2</p>	<ol style="list-style-type: none"> <li>1. Check the ambient temperature conditions, and check all fans.</li> <li>2. Refer to "Isolating Drive Sled Problems" on page 7-9.</li> </ol>

Table 8-1. Main Error Codes (continued)

Error Code	Description	User Action
F1	<p>Drive Communication Error</p> <p>Library controller has lost communication to drive</p> <p>The subcode indicates which drive is affected.</p> <p><u>Example:</u></p> <p>Subcode 02: drive #2</p>	
F2	<p>Drive Sled not present</p> <p>The subcode indicates which drive sled is affected.</p> <p><u>Example:</u></p> <p>Subcode 02: drive sled #2</p>	
F3	<p>Drive Hardware Error</p> <p>The subcode indicates which drive is affected.</p> <p><u>Example:</u></p> <p>F3 xy</p> <p>Where x refers to the hardware drive error code (single character display) and Y refers to the drive position in the library. x values:</p> <ul style="list-style-type: none"> <li>• 4: firmware or hardware error</li> <li>• 5: hardware error</li> <li>• 6: hardware or media error</li> <li>• A: recoverable hardware error</li> </ul>	<p>Refer to "Isolating Drive Sled Problems" on page 7-9.</p>
F4	<p>Drive Load Timeout</p> <p>Drive has run in a timeout while loading a tape.</p> <p>The subcode indicates which drive is affected.</p> <p><u>Example:</u></p> <p>Subcode 02: drive #2</p>	
F5	<p>Drive Unload Timeout</p> <p>Drive has run in a timeout while unloading a tape</p> <p>The subcode indicates which drive is affected.</p> <p><u>Example:</u></p> <p>subcode 02: drive #2</p>	

Table 8-1. Main Error Codes (continued)

Error Code	Description	User Action
F6	No drive installed. A drive has never been installed	Refer to "Isolating Drive Sled Problems" on page 7-9.
F7	Support ticket download from drive not possible	
F8	Invalid drive command	
F9	Invalid drive parameter	
FA	SDCI microcode error	
FB	Drive logged out	
FC	Internal SCSI command failed with check condition	
FD	Internal SCSI command timeout	

### Sub Error Codes

Table 8-2. Sub error codes

Error Code	Description
<b>ROBOTICS</b>	
00	No sub error code
01	Mechanical initialization failure
02	Connection to slave robotic failed
03	Error motor initialization
04	Error during gripper close
05	Error slider home positioning
06	Error elevator home movement
07	Error during sled movement to rotation position
08	Error during rotation initialization, get range failed
09	Error elevator init
0A	Error during rotation to far position
0B	Error first sled init, move to sensor failed
0C	Error during sled movement to rotation position
0D	Error during rotation to drive position
0E	Error slider init, get range failed
0F	Error during slider forward movement
10	Error gripper init, get range failed

Table 8-2. Sub error codes (continued)

11	Error during slider home movement
12	Error during rotation to FAR position
13	Error sled init, move to sensor failed
14	Error during sled movement; check shipping lock
20	Error Inventory scan
21	Error during gripper close
22	Error slider home movement
23	Error during move gripper to scan pos
24	Error reading barcode label
25	Error during move sled to scan position
26	Error during move elevator to scan position
27	Error during sled preposition movement
28	Error Extra inventory scan
29	Error during closing gripper
2A	Error slider preposition movement
2B	Error during opening gripper
2C	Error during sled movement up to sensor
2D	Error slider preposition backwards movement
30	Error slot preposition
31	Error during sled movement in FLMoveRotation function
32	Command sending to robotic failed
33	Error during elevator movement in FLMoveRotation function
34	Error during rotation in FLMoveRotation function
35	Error during elevator movement in FLMoveSled function
36	Error during sled movement in FLMoveSled function
37	Error during sled positioning to sensor in FLMoveSled function
38	Error during sled positioning to mail slot in FLMoveSled function

Table 8-2. Sub error codes (continued)

39	Error during sled positioning without sensor
3A	Error during elevator movement without sensor
3B	Error slot position sensor not found
40	Movement to/from slot failed
41	Error during first slider movement
42	Error during first gripper movement
43	Error during second slider movement
44	Error during second gripper movement, get range failed
45	Error during third slider movement, move home failed
46	Error during set hold current to avoid torsion
47	Negative direction blocked
48	Positive direction blocked
49	Possible motor defect, because both directions blocked
4A	Cartridge present sensor defect
4B	Inventory lost, because destination possibly full
4C	Inventory lost, because source may be empty
4D	Could not pull tape out of slot from magazine
4E	Unexpected tape on elevator, possible inventory lost
50	Preposition to drive failed
51	Elevator movement to home sensor failed.
52	Sled movement to home sensor failed.
53	Error during sled movement to drive position.
54	Error during rotation to drive position.
55	Error during elevator movement in drive position.
56	Error during sled movement to rotation position.
57	Error during rotation to end position.
60	Move from/to drive failed.
61	Error during first slider movement.
62	Error during first gripper movement.
63	Error during second slider movement.
64	Error during second gripper movement, get range failed.
65	Error during third slider movement, move home failed.
70	Release magazine failed.
71	Error during sled movement to rotation position.
72	Error during rotation to unlock position.
73	Error during move sled to block.
80	Opening I/O slot failed.

Table 8-2. Sub error codes (continued)

81	Error during movement to I/O slot open position.
82	Error during moving back - sensor was found.
90	Movement to home position failed.
91	Elevator movement to home position failed.
92	Error during sled movement to rotation position.
93	Error during rotation to home or far position.
94	Sled movement to home sensor position failed.
95	Sled movement to transport position failed.
A0	Movement of I/O slot failed.
A1	Sled movement to sensor failed.
A2	Sled movement to rotation position failed.
A3	Elevator movement to home position failed.
A4	Error during rotation to far position.
A5	Sled movement to I/O slot position failed.
A6	Error during elevator movement to position
A7	Error during mailslot detection
B0	EEPROM on robotics controller not accessible or error during Read/Write operation
B1	Save/restore configuration settings: not enough internal memory available for creating the file and restoring the file respectively
B2	Save/restore configuration settings: restore buffer corrupted, checksum calculation failed
B3	Save/restore configuration settings: data base field corrupted
B4	Save/restore configuration settings: invalid personality
B5	Save/restore configuration settings: invalid file
<b>LIBRARY</b>	
81	Drive wake up failed
88	Error accessing slot status
90	Accessor load not reached Cartridge Present sensor
91	No activity after Load command
92	Timeout while loading tape
93	No activity after load command
94	Timeout drive Unload
95	Drive terminated unsuccessfully
96	Tape not ejected at robot unload
97	Slot not free at robot unload
98	Cartridge not seated in load phase



## Warning Events

Warning events described in this section are reported via email notification. The Attention LED will blink when warning events for the following occur:

- Media
- Fan
- Redundant power supply

An appropriate message will be posted on the Operator Control Panel and the Web User Interface.

*Table 8-3. Warning Events*

30	SCSI: transport element full	Refer to your host application documentation for problem determination information.	
31	SCSI: all slots empty		
32	SCSI: invalid opcode		
33	SCSI: invalid element address		
34	SCSI: invalid field in CDB		
35	SCSI: Invalid drive specified		
36	SCSI: SEND DIAGNOSTIC command: invalid test number		
37	SCSI: invalid LUN		
38	SCSI: parameter list length error		
39	SCSI: parameter list error: invalid field		
3A	SCSI: parameter list error: parameter not supported		
3B	SCSI: parameter value invalid		
3C	SCSI: saving parameters not supported		
3D	SCSI: invalid ID message		
3E	SCSI: destination element full		
3F	SCSI: source slot or drive empty		
40	SCSI: wrong checksum		
41	SCSI: command sequence error		
42	SCSI: drive disabled		Check your configuration settings.
43	SCSI: I/O Station disabled		
44	SCSI: flash image does not fit bootcode	Refer to your host application documentation for problem determination information.	
45	SCSI: media removal prevented by drive		
46	SCSI: media removal prevented by library		
47	SCSI: flash image does not fit personality	Check the version of firmware used for the upgrade.	
48	SCSI: drive type not supported in this library	Check whether a version of firmware is available which supports this drive type. For a list of supported drives, refer to "Ultrium Tape Drives" on page 1-9.	
49	SCSI: incompatible magazine, magazine not accessible	Check your configuration settings.	
4A	SCSI: source not ready	Complete move process and retry operation.	
4B	SCSI: destination source not ready		

Table 8-3. Warning Events (continued)

4C	SCSI: library controller busy	Complete process and retry operation.
4D	SCSI: cannot make reservation	Refer to your host application documentation for problem determination information.
4E	SCSI: invalid slave robotic controller request	
4F	SCSI: robotic axes/motors aren't initialized	Check robotics status. Refer to "Isolating a Library Controller Card vs. Accessor Enclosure Problem" on page 7-10.
50	SCSI: cartridge belongs to another partition	Refer to your host application documentation for problem determination information.
54	SCSI: failure in LME interface	<ol style="list-style-type: none"> <li>1. Check your Encryption configuration.</li> <li>2. Run Key Path Diagnostics.</li> <li>3. Refer to your EKM server documentation.</li> </ol>
55	SCSI: invalid license key entered	Re-enter license key. If problem persists, refer to technical support.
58	Recovered Error: SCSI parity error	No user action is required.
59	Recovered Error: Error log overflow	
5A	Illegal request, downgrade prohibited	Disable encryption for firmware downgrade.
5B	Incompatible medium generation	Replace incorrect cartridge(s).
5C	Illegal request, downgrade prohibited because of incompatible network stack	Change network settings to IPv4 only before downgrading firmware.
5D	Illegal request, wrong drive FW for drive	Obtain correct drive firmware image.
5E	Full height drive in illegal position	Check correct Drive position.
60	Cleaning cartridge installed	Complete the cleaning process and retry the operation.
61	Cleaning failure. Cleaning process could not be performed	<ol style="list-style-type: none"> <li>1. Verify that autoclean is enabled.</li> <li>2. Check for an expired cleaning cartridge and replace if necessary.</li> <li>3. Refer to "Configuring I/O Stations and Reserving Slots" on page 5-65.</li> </ol>
62	Cleaning cartridge expired	Replace cleaning cartridge.
63	Invalid cartridge. Drive has rejected the data cartridge as invalid	<ol style="list-style-type: none"> <li>1. Verify that the correct cartridge is being used. Refer to "Cartridge Compatibility" on page 6-2.</li> <li>2. Refer to "Identifying a Suspect Cartridge" on page 7-12.</li> </ol>
64	Invalid cleaning cartridge. Drive has rejected the cleaning cartridge as invalid	
65	Invalid upgrade cartridge. Drive has rejected the upgrade cartridge as invalid	Not supported
66	Medium error; diagnostic tape write protected	Ensure diagnostic tape is not write protected.
67	Medium error, incompatible medium for write operation	Replace incorrect cartridge(s).
70	Currently not used	
71	Currently not used	
72	Currently not used	
73	SCSI: overlapped command attempt	Refer to your host application documentation for problem determination information.
74	SCSI: echo buffer overwritten	
80	Movement Retry.	

Table 8-3. Warning Events (continued)

81	Fan Alert.	
82	Clean request from drive.	
83	Media Attention.	
84	Drive reported warning or critical tape alert flag.	
85	Network problem.	Check network connections, configuration, and settings.
86	Not enough cleaning cartridges present to autoclean.	Insert additional cleaning cartridges to the empty reserved slots.
87	Drive disabled because it is not supported for use in this library.	Check drive type and install only supported drives.
88	Drive firmware unchanged after upgrade.	This is normal if the old and new drive firmware are the same version.
89	Power Supply Fan operation warning.	Check the power supply status.
8A	Power Supply has failed.	Check the power supply status and replace the failed power supply.
8B	Power supply has failed.	Check the power supply status and replace the failed power supply.
8C	Invalid Robotic Code.	Install the latest version of library firmware.
8E	Cleaning tape nearly expired.	Continue using cleaning cartridge until it is expired, then replace the expired cleaning cartridge with a new cleaning cartridge.
8F	I2C bus recovery.	Run library System Test.
92	VPD data have been restored from EEPROM.	This is normal when the VPD has been restored EEPROM.
DB	External cooling fan error (fan motion has stopped).  The subcode indicates which drive sled fan is affected  Subcode 01: drive sled #1(bottom)  Subcode 02: drive sled #2	Refer to "Isolating Drive Sled Problems" on page 7-9.
DC	I <sup>2</sup> C Bus Failure	
DD	Power Supply x fan has failed,  Redundancy may be at risk  The subcode indicates which power supply fan is affected  Subcode 01: 1st PS fan from bottom  Subcode 02: 2nd PS fan from bottom	Refer to "Isolating a Power Supply Problem" on page 7-7.
DF	Power Good signal changed from 2 to 1 Power Supplies	
F6	No drive installed. A drive has never been installed.	Install at least one drive.



---

## Chapter 9. Service Procedures

---

### Removing Cartridges from Magazine Slots

In the event of a severe mechanical problem with the library or if circumstances require you to remove tape cartridges, do the following. If the Operator Control Panel or the Web User Interface is still operational:

1. Move the tapes from the drive(s) to the magazines using the **Move Media** command. See “Manage Library: Move Media” on page 5-42.

**Note:** Contact technical support if a cartridge will not eject from the drive.

2. Use the magazine removal process to release the magazine and remove it from the library. To use the Operator Control Panel, see “Control: Magazine” on page 5-17. To use the Web User Interface, see “Manage Library: Release Magazine” on page 5-43. If neither one of these processes works, see “Releasing the Magazines Manually.”

---

### Releasing the Magazines Manually

If the directions in Steps 1 and 2 above do not allow you to remove the tapes, do the following:

1. Unplug the power cord from the library.
2. Find the access holes for the right and left magazines.



Figure 9-1. Access holes for the left magazine

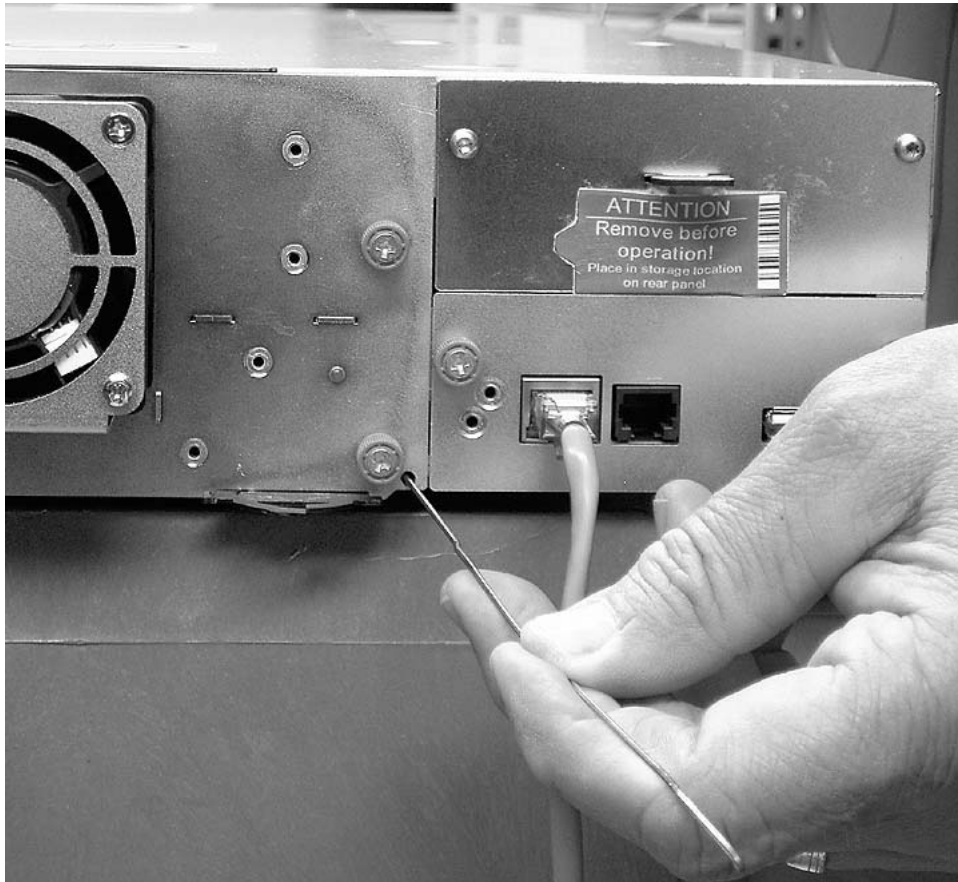

Figure 9-2. Access holes for the right magazine

3. To manually release the magazines, push the end of a straightened paper clip into the access hole for each magazine at the back of the library. While holding the paper clip, have a second person pull the magazine out of the front of the unit. DO NOT push the paper clip in more than 1/2 inch.



a77ug023

Figure 9-3. Left magazine pulled out of the 2U library



a77ug102

Figure 9-4. Left Magazines pulled out of the 4U Library

4. If there are additional tapes still in the library, or if you were unable to manually remove the magazines and drive, contact technical support for further instructions.

---

## Using the ITDT Firmware Update, Dump Retrieval and Drive Test Tool

ITDT has multiple functional capability and is a very quick, convenient and efficient method for drive firmware updates. As a note, drive dump retrievals can be performed by the tool as well.

The ITDT Tool:

- Runs quick or extended diagnostics on tape drives. If the library is online to the server/host where the tool resides, ITDT will communicate with the drive through the library to load and unload a test cartridge thereby exercising some library functions.
- Retrieves firmware dumps from tape drives and libraries.
- Performs a firmware update on tape drives or libraries. See note below regarding library firmware update.
- Tests the performance of the environment by completely writing a cartridge and measuring performance.
- Retrieves and displays cartridge information.
- Verifies the encryption environment.
- Does not require special device drivers.
- Is available for most major platforms.

**Note:** ITDT v4.1 or higher is required for Ultrium 5 tape drives. Before using ITDT, verify that your library host operating system is at the latest released level. This will ensure optimum read/write operations for diagnostics.

**Note:** If the library has a BCR (Barcode Reader) that requires 9.00 or greater firmware, the Update function will terminate with an error code of "Unexpected Data" if you attempt to downlevel the library firmware.

To download the ITDT tool and instructions for using the tool, visit <http://support.dell.com>.



---

## Chapter 10. Check, Adjust, Remove, and Replace

---

### Tools Required

To service a library you may need one or more of the following tools:

- #2 Phillips screwdriver
- Ground strap (recommended, if available)

---

### Electrostatic Discharge

**Important:** A discharge of static electricity can damage static-sensitive devices or microcircuitry. Proper packaging and grounding techniques are necessary precautions to prevent damage.



Figure 10-1. ESD label

To prevent electrostatic damage, observe the following precautions:

- Transport products in static-safe containers such as conductive tubes, bags, or boxes.
- Keep electrostatic-sensitive parts in their containers until they arrive at static-free stations.
- Cover the unit with approved static-dissipating material. If available, provide a ground strap connected to the work surface and properly grounded tools and equipment. If a ground strap is not available, touch a metal surface to discharge any static electricity in your body.
- Keep the work area free of non-conducting materials, such as ordinary plastic assembly aids and foam packing.
- Make sure you are always properly grounded when touching a static-sensitive component or assembly.
- Avoid touching pins, leads, or circuitry.
- Use conductive field service tools.

---

### Relocating Your Library

When moving or shipping your library, it is important that the shipping lock be in place to prevent the accessor from moving and to protect the library from possible damage. Before relocating your library, complete the following procedure.

1. Remove all cartridges from inside the library.
2. Power OFF the library. This will align the robot with the shipping lock slot.
3. Remove any cables and terminators connected to the library.
4. Remove the library from the rack, if necessary.
5. Remove the shipping label ( **2** ) and lock ( **1** ) from the rear panel of the library.



Figure 10-2. Shipping Lock and Label Storage Location

6. Insert the shipping lock ( **1** ) into the slot located on the center of the top of the library and secure with the shipping label ( **2** ).



Figure 10-3. Shipping Lock and Label

7. Pack the library in its original packaging materials (or equivalent packaging) for moving or shipping.

Table 10-1. Shipping Lock/Shipping Label

<b>1</b>	Shipping Lock
<b>2</b>	Shipping Label

---

## Removing/Installing/Adding a Tape Drive Sled

There are two types of drive sleds in a TL2000 library (2U library) and a TL4000 library (4U library). The contents of the ship groups are specific to the type of drive sled.

- Drive sled without ElectroStatic Discharge (ESD) springs (see Figure 10-4) ship group:
  - Drive sled without ESD springs
  - Packet of conductive tape to be applied to the drive sled for ESD protection
- Drive sled with ESD springs (see Figure 10-5 on page 10-4) ship group:
  - Drive sled with ESD springs

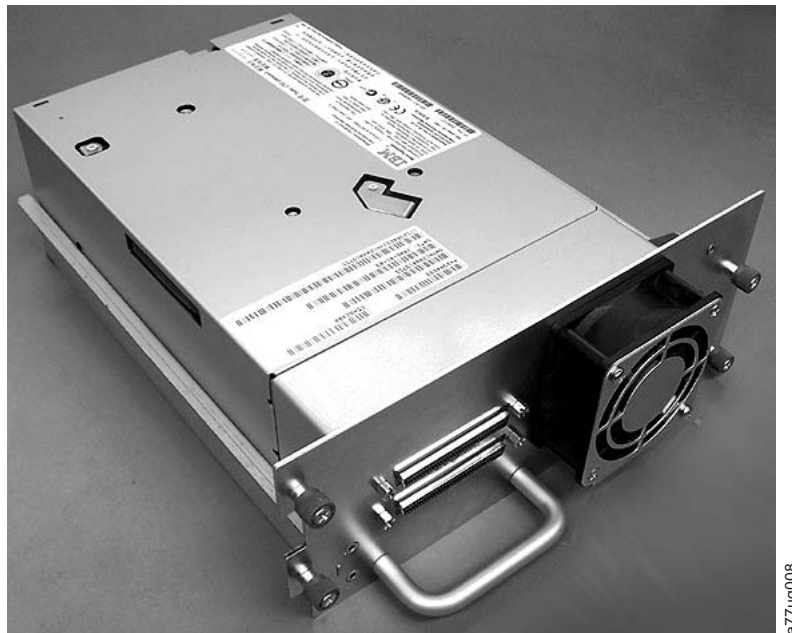

Figure 10-4. Library drive sled without ElectroStatic Discharge (ESD) springs (SCSI sled shown)

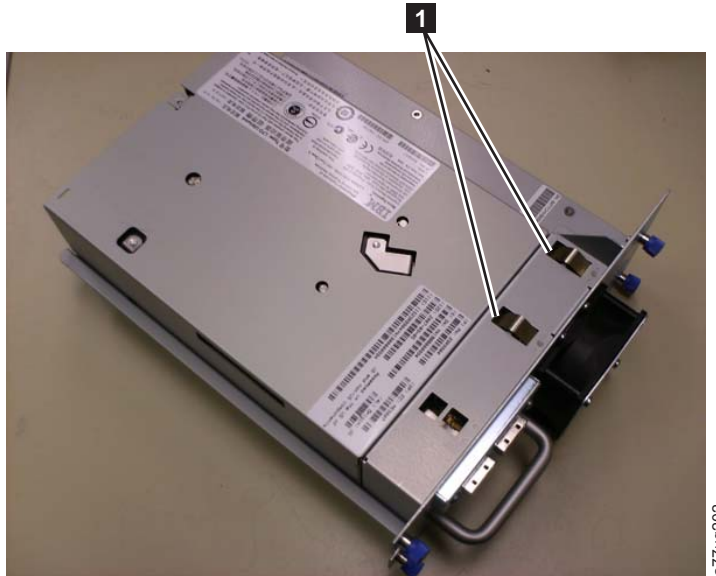

Figure 10-5. Library drive sled with ESD springs [1] (SAS sled shown)

## Removing a Tape Drive Sled

1. IT IS IMPORTANT TO PRESERVE A DRIVE DUMP FOR ANALYSIS IF ALL OF THE FOLLOWING CONDITIONS EXIST:
  - Library Error LED is ON.
  - Operator Control Panel is displaying a drive error message.
  - Web User Interface System Status screen is indicating that a drive has failed.IF NONE OF THE CONDITIONS LISTED ABOVE EXIST, PROCEED TO THE NEXT STEP.
2. Power OFF the library before removing and/or installing a SCSI drive sled. Fibre Channel and SAS drive sleds are hot pluggable and may be removed and installed while the library is powered ON.
3. If necessary, unload the tape cartridge from the drive to be removed.
  - Using the Operator Control Panel: **Control** → **Move Cartridges**
  - Using the Web User Interface: **Manage Library** → **Move Media**
4. Remove the host interface cable ( **1** , **2** , or **4** in Figure 10-6 on page 10-5) and terminator ( **3** for SCSI drive sled only).

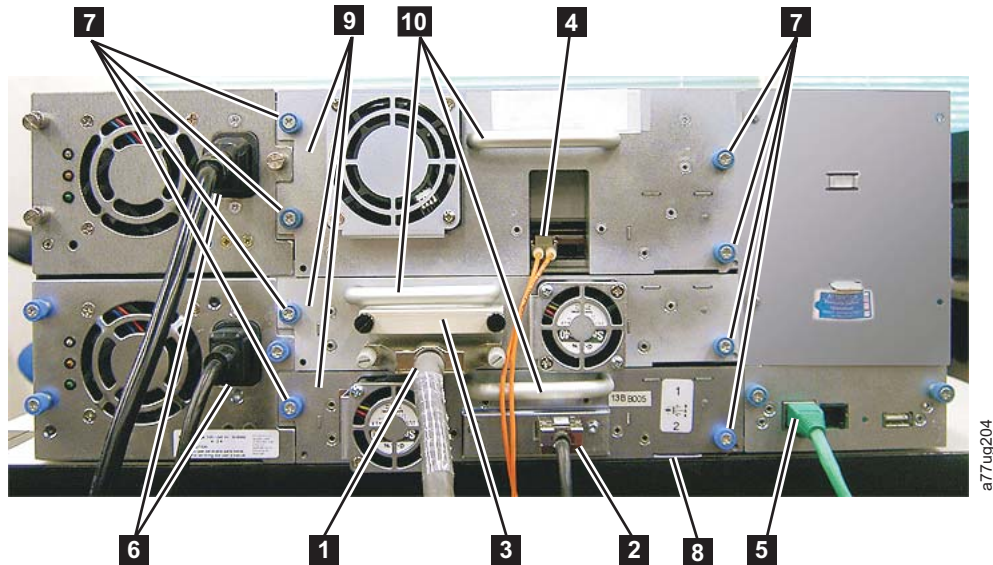

Figure 10-6. Drive sled components (full-high fibre drive in top position, half-high SCSI drive in middle position, half-high SAS drive in bottom position) on back panel of a 4U library

<b>1</b>	SCSI cable
<b>2</b>	SAS cable
<b>3</b>	SCSI terminator
<b>4</b>	Fibre Channel cable
<b>5</b>	Ethernet cable
<b>6</b>	Power cords
<b>7</b>	Drive sled blue captive thumbscrews
<b>8</b>	Black pull-out tab
<b>9</b>	Drive sled
<b>10</b>	Drive sled handle

5. If present, remove the conductive tape from the drive sled (refer to Figure 10-9 on page 10-8).
6. Loosen the blue captive thumbscrews ( **7** in Figure 10-6) on the drive sled.
7. Pull straight back on the drive sled handle ( **10** ) to remove it from the library (see Figure 10-7 on page 10-6).
8. If you are replacing the tape drive sled, proceed to Installing a Tape Drive Sled for instructions. If you are not replacing the tape drive sled immediately, you will need to perform the following procedures:
  - a. Install a drive cover plate to protect your library from dust and debris.
  - b. To remove the "Missing drive" indicators on the Operator Control Panel (Attention LED) and the Web User Interface (System Status screen), modify or resubmit logical library setting (Operator Control Panel: **Configure** → **Logical Libraries** or Web User Interface: **Configure Library** → **Logical Libraries**).



Figure 10-7. Pulling the drive sled out of the library (drive sled without ESD springs shown)

## Installing a Tape Drive Sled

**Note:** Power OFF the library before installing a SCSI drive sled. Fibre Channel and SAS drive sleds are hot pluggable and may be removed and installed while the library is powered ON.

**Important:** In a 4U library a full height drive sled may be installed in drive slot 1 (drive will occupy slot 1 and slot 2) or drive slot 3 (drive will occupy slot 3 and slot 4). A full height drive sled should never be installed in drive slot 2 (drive will occupy slot 2 and slot 3).

1. Before installing the new drive sled, inspect all connectors on the drive sled. Ensure that the connectors are intact, free of any foreign objects, and have no cracks, deformed, or bent contacts.
2. Extend the black pull-out tab ( **8** in Figure 10-6 on page 10-5) located underneath the library near the lower right corner of the drive sled.
3. Slowly insert the new drive sled into the drive slot while supporting the bottom of the drive sled (see Figure 10-8 on page 10-7). Ensure that the black tab remains extended ( **8** in Figure 10-6 on page 10-5).

**Important:** Push in on the drive sled handle ( **10** in Figure 10-6 on page 10-5) while supporting the bottom of the drive sled until it is properly seated. Damage to the connector pins may occur if this procedure is not followed.

4. Push the drive sled slowly into the drive slot until the sled seats itself against the back of the library.



Figure 10-8. Pushing the drive sled into the library (drive sled without ESD springs shown)

5. Tighten the captive thumbscrews ( **7** in Figure 10-6 on page 10-5) until the drive sled is secure.
6. If you are installing a drive sled without ESD springs (see Figure 10-4 on page 10-3), apply conductive tape to the sled as shown in Figure 10-9 on page 10-8.

## 2U Library

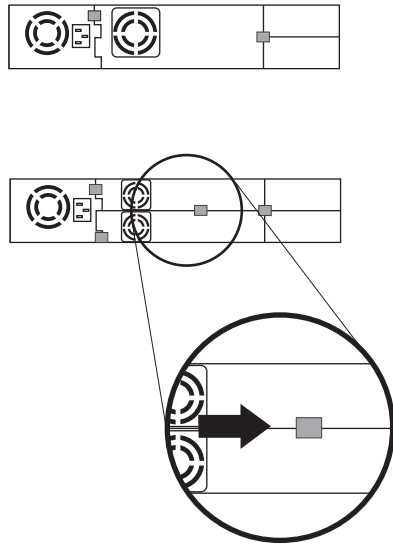

## 4U Library

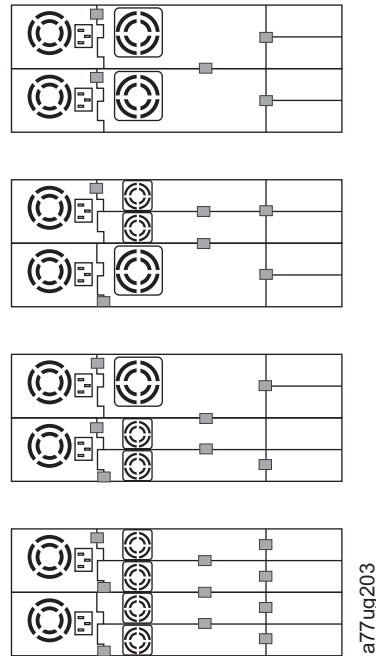

a77ug203

Figure 10-9. Diagrams for applying conductive tape for ESD protection to the back of a drive sled installed in a 2U or 4U library

**Note:** The small gray markers show where conductive tape should be placed to provide ESD protection.

7. Push the black tab ( **8** in Figure 10-6 on page 10-5) back underneath the library. When inserted properly, only the handle of the tab will be visible.
8. Upgrade library firmware and drive firmware to the latest version.  
Refer to “Configure Library: Drives” on page 5-49 to configure the drive if it is a SCSI or FC drive. Connect the drive host interface cable to the host or FC switch.

**Note:** Go to <http://support.dell.com> to download the latest firmware for your library and tape drive(s).

9. Run the Library Verify test. (Operator Control Panel: **Service** → **Library Verify**). This test requires the use of a scratch (blank) cartridge.
  - If the test passes:
    - When prompted by the Operator Control Panel display and the I/O Station opens, remove the cartridge used in the test.
    - Close the I/O Station by pushing it back into the library.
    - Press **Cancel** to exit the Library Verify screen.
    - Resume normal library operations.
  - If the test fails, an error code will be displayed. Make note of the error, then refer to the Troubleshooting chapter in this document for additional instructions.
10. Package the failed drive sled in the same packaging in which the new sled was shipped to you and return to Dell.



**Important:** If the failed drive was configured for encryption, to ensure the replacement drive receives the proper encryption parameters, resubmit the encryption choices listed on **Configure Library** → **Encryption** for that particular drive or logical library even if the encryption settings did not change.

## Adding a Tape Drive Sled

Use these instructions to add a new tape drive to your 2U or 4U Tape Library. Refer to Appendix A, “SCSI Element Types, SCSI Addresses, and Physical Configurations,” on page A-1 for more information.

**Note:** Power OFF the library before installing a SCSI drive sled. Fibre Channel and SAS drive sleds are hot pluggable and may be removed and installed while the library is powered ON.

**Important:** In a 4U library a full height drive sled may be installed in drive slot 1 (drive will occupy slot 1 and slot 2) or drive slot 3 (drive will occupy slot 3 and slot 4). A full height drive sled should never be installed in drive slot 2 (drive will occupy slot 2 and slot 3).

Complete the following procedure to add a new tape drive to your library.

1. Before installing the new drive sled, inspect all connectors on the drive sled. Ensure that the connectors are intact, free of any foreign objects, and have no cracks, deformed, or bent contacts.
2. Slowly insert the new drive sled into the drive slot while supporting the bottom of the drive sled (see Figure 10-8 on page 10-7). If necessary, ensure that the black tab remains extended ( **8** in Figure 10-6 on page 10-5). Push in on the drive sled handle ( **10** in Figure 10-6 on page 10-5) while supporting the bottom of the drive sled until it is properly seated.

**Important:** Damage to the connector pins may occur if this procedure is not followed.

3. Tighten the captive thumbscrews ( **7** in Figure 10-6 on page 10-5) until the drive sled is secure.
4. If you are installing a drive sled without ESD springs (see Figure 10-4 on page 10-3), apply conductive tape to the sled as shown in Figure 10-9 on page 10-8.

**Note:** The small gray markers show where conductive tape should be placed to provide ESD protection.

5. Install cover plates on any open drive slots in the library.
6. Power ON the library.
7. Run the Library Verify test. (Operator Control Panel: **Service** → **Library Verify**). This test requires the use of a scratch (blank) cartridge.
  - If the test passes:
    - When prompted by the Operator Control Panel display and the I/O Station opens, remove the cartridge used in the test.
    - Press **Cancel** to exit the Library Verify screen.
    - Proceed to “Configuring the Tape Drive” on page 10-10.
  - If the test fails, an error code will be displayed. Make note of the error, then refer to the Troubleshooting chapter in the *Dell PowerVault TL2000 Tape Library and TL4000 Tape Library User’s Guide* for additional instructions.

## Configuring the Tape Drive

1. Log on to the Web User Interface.
2. Verify that you are running the latest version of Library firmware and drive firmware (library firmware: **Monitor Library** → **Library Identity**; drive firmware: **Monitor Library** → **Drive Identity**). Upgrade, if necessary (**Service Library** → **Upgrade Firmware**).
3. Use the Web UI to update the Logical Library (**Configure Library** → **Logical Libraries**) and Drive (**Configure Library** → **Drives**) configurations. Refer to Chapter 5, "Operations," on page 5-1. Select **Submit** on the **Configure Library** → **Logical Libraries** web page even if there are no required changes. This action will refresh the Data Transfer Element (DTE) for the drives. Refer to Appendix A, "SCSI Element Types, SCSI Addresses, and Physical Configurations," on page A-1 for information regarding DTE addressing. If **Configure Library** → **Logical Libraries** does not correctly refresh/update the DTE addresses, execute step 3 and step 4. Otherwise, proceed to Step 5.
4. Reconfigure your library using the OCP to configure your network settings, then using the Web UI to complete your library configuration.
5. Save your library configuration to your host computer or to a USB device.
6. Update your Library Configuration Form with the new drive and configuration information.
7. Resume normal library operations.

---

## Replacing a Power Supply

1. Power OFF the library by pressing and holding down the power button for 4 seconds.
2. Disconnect the power cord from the electrical source, then from the library.
3. Loosen the three blue captive thumbscrews on the power supply located on the back panel of the library.
4. Pull on two of the thumbscrews to pull the unit away from the rear panel of the library, then grasp the top and bottom edge of the power supply and pull it out of the library.



Figure 10-10. A power supply being removed from a 2U library

5. Remove the packaging from the replacement power supply.
6. Grasp the top and bottom edge of the power supply and push it into the library.
7. Tighten the three blue captive thumbscrews on the power supply located on the back panel of the library.
8. Connect the power cord to the library, then to the electrical source.
9. Power ON the library using the power button on the front panel.
10. Run the Library Verify test (refer to “Service: Library Verify” on page 5-30).
11. Package the failed power supply in the same packaging in which the new power supply was shipped to you and return to Dell.

---

## Replacing a Library Controller Card

### Read Me before Continuing

The Library Controller Card contains a copy of the vital product data (VPD) for your library. The VPD contains your current library configuration. A backup copy of this VPD is contained within the electronics of the Library Enclosure. When the Library Controller Card is replaced, the new replacement card should contain zeros (0's) in key VPD locations. Upon detection of these zeros, the library will automatically attempt to write VPD data to the new Library Controller Card from the backup copy of the VPD contained in the Library Enclosure. In rare occurrences, the new Library Controller Card may contain valid (non-zero) VPD data left over from having been installed previously in another library. If this occurs, the library, which is expecting to see zeros in the VPD area, will instead detect valid VPD data, and will not know which copy of the VPD is the correct one. It will detect a “VPD Mismatch” and display on the Operator Control Panel a screen entitled “VPD Selection”, where it is asking you to determine which copy of VPD should be written to the new Library Controller Card.

If the message "VPD Selection" is displayed at the Operator Control Panel, carefully highlight the "VPD from Enclosure" option to copy that version of the VPD to the new Library Controller Card. Then continue with the procedure.

### Removal and Replacement

1. Power OFF the library by pressing and holding the power button at the front of the library for 4 seconds.
2. Disconnect the power cord from the electrical source, then from the power supply or supplies at the back of the library.
3. Loosen the two blue captive thumbscrews on the Library Controller Card.
4. Grasp the two thumbscrews and pull the defective Library Controller Card out of the library.



Figure 10-11. A Library Controller Card being removed from the library

5. Remove the packaging from the replacement Library Controller Card.
6. Grasp the two thumbscrews and push the replacement Library Controller Card into the library.
7. Tighten the two blue captive thumbscrews on the Library Controller Card.
8. Connect the power cord to the power supply or supplies at the back of the library, then to the electrical source.
9. Power ON the library using the power button on the front panel.
10. After power is restored to the Library Controller Card, the library will automatically restore the VPD on the new Library Controller Card from the Library Enclosure. If a "VPD Selection" message is displayed in the Operator Control Panel, see the "Read Me before Continuing" section earlier in this procedure to determine how to respond to the message.
11. Upgrade library firmware and drive firmware to the latest version. See "Service Library: Upgrade Firmware" on page 5-62.
12. Run the Library Verify test (refer to "Service: Library Verify" on page 5-30).

**Note:** Use care when selecting the appropriate VPD to restore from/to. An error in selection here could cause a long downtime.

13. Package the failed Library Controller Card in the same packaging in which the new control board was shipped to you and return to Dell.

---

## Replacing Cartridge Magazines

To replace a cartridge magazine, refer to one of the following procedures:

- Using the Web User Interface, refer to “Manage Library: Release Magazine” on page 5-43.
- Using the Operator Control Panel, refer to “Control: Magazine” on page 5-17.
- If your library can not be powered ON, refer to “Releasing the Magazines Manually” on page 9-1.

---

## Replacing the Library Enclosure

This procedure is necessary when the library enclosure, accessor, or display fails. These components are contained within the replacement library enclosure.

**Important:** Refer to the Installation Instructions that are included with the new replacement library enclosure. Follow the procedures included in this document for replacing the Library Enclosure, only if Installation Instructions are not included with the new replacement library enclosure.

The replacement library enclosure includes , and a packet of library foot pads. will be removed from the replacement library enclosure and returned to Dell in the defective library. The parts currently in your defective library will be removed, and installed into the replacement library enclosure.

**Note:** To reduce the risk of personal injury or damage to equipment:

- observe local health and safety requirements and guidelines for manual material handling
- obtain adequate assistance to lift and stabilize the library during installation or removal

**Minimum Installation Time:** 1 hr.

**Minimum Number of Persons Required:** 2

**Recommended Tools:** #2 Phillips screw driver, paper clip, blank (or scratch) data cartridge

## Preparing the Defective Library for Replacement

1. If possible, use the Operator Control Panel to unload any drives that contain a cartridge (**Control** → **Move Cartridges**).
2. Power OFF the defective library.
3. Disconnect all cables from the rear panel of the defective library.
4. If the defective library is rack mounted, remove the two screws (**1** in Figure 10-12 on page 10-14) from the front of the defective library anchoring the mounting brackets on the library to the rack. With assistance, remove the defective library from the rack.



a77ug244

Figure 10-12. Removing the two mounting bracket screws anchoring the library to the rack (one screw on each side of the library)

5. Place the defective library on a clean and sturdy work surface.
6. Proceed to “Unpacking and Preparing the Replacement Library Enclosure.”

## Unpacking and Preparing the Replacement Library Enclosure

Before installing the replacement library enclosure, it is important to verify that the enclosure is functioning properly.

1. Unpack the replacement library enclosure and place it on a sturdy and clean work surface near the defective library. Save all packaging materials for returning the failing part(s) to Dell.
2. Choose one of the options below for installing the foot pads.

**Important: Operating your library on a flat surface without foot pads may damage your library or cause it not to function properly.**

- Rack Mount - temporary placement of the foot pads
  - Desktop - permanent placement of the foot pads
- a. For a rack mounted library:
    - 1) Lift the replacement library enclosure slightly above the work surface, have another person place a foot pad under each corner of the library and on each side of the library halfway between the front and back.
    - 2) Gently set the replacement library enclosure on top of the feet. Adjust foot pad placement as necessary to stabilize the library. Do not permanently attach the foot pads to the library.

- b. For a desktop library:
- 1) Carefully, lay the library on its side.
  - 2) Peel the adhesive from the back of each of the six foot pads.
  - 3) Install the foot pads on the bottom of the library enclosure by pressing each foot into one of the six areas ( **1** ) as shown in Figure 10-13.

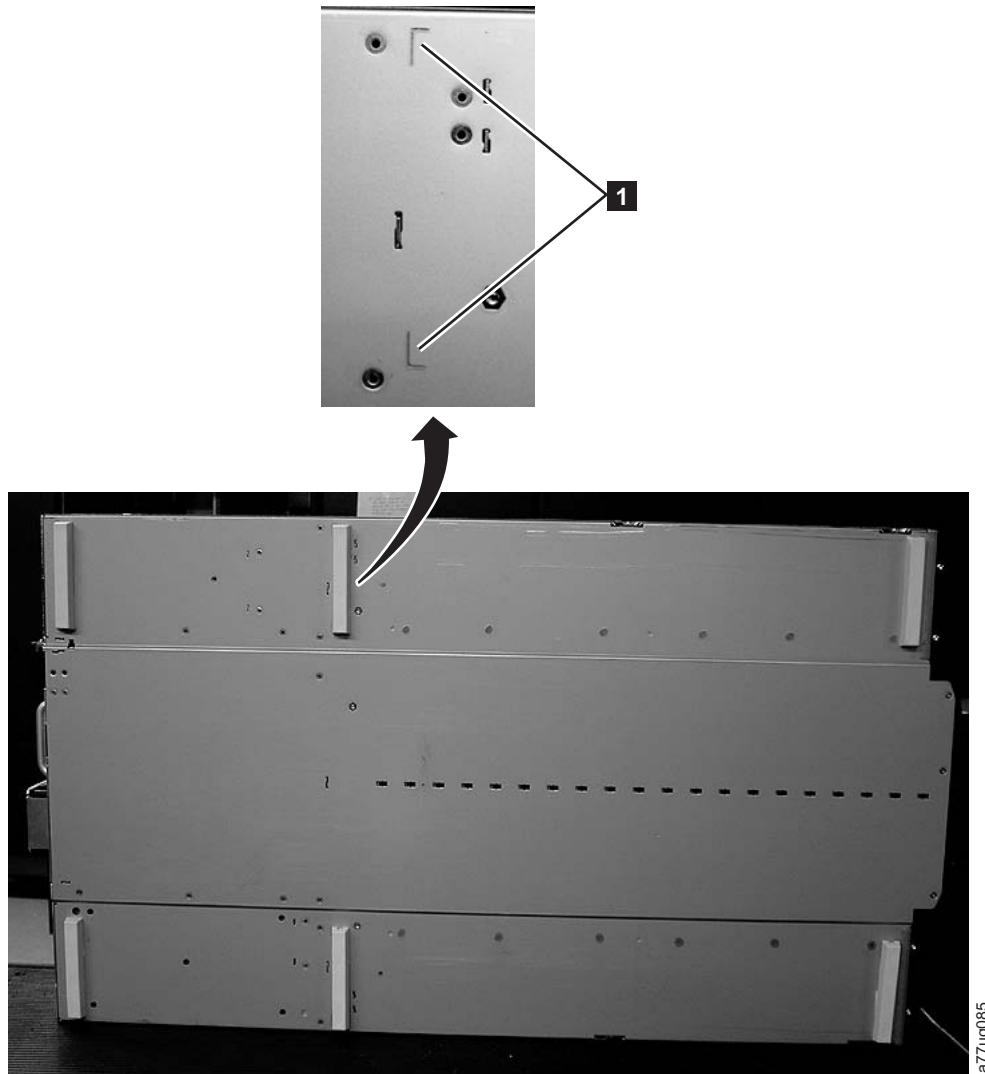

Figure 10-13. Foot pads installed on the bottom of the library enclosure

3. Carefully return the library to an upright position.
4. Remove the shipping lock from the top of the replacement library enclosure (see Figure 10-14 on page 10-16).

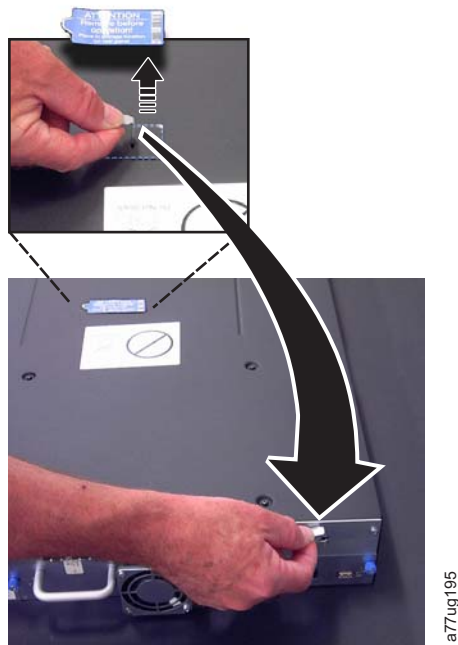

Figure 10-14. Removing the shipping label and lock from the top of the library and storing on the rear panel

5. Store the lock and label on the back panel of the replacement library enclosure (see Figure 10-15).



Figure 10-15. Library shipping lock and label storage location on the rear panel of the library

6. Proceed to “Installing Your Drive(s) in the Replacement Library Enclosure.”

## Installing Your Drive(s) in the Replacement Library Enclosure

**Note:** It is important to install the drives from the defective library into the same positions in the replacement library enclosure in order to maintain your current library configuration.



Remove all drives from the defective library (see Figure 10-16) and install them in the same positions in the replacement library enclosure.

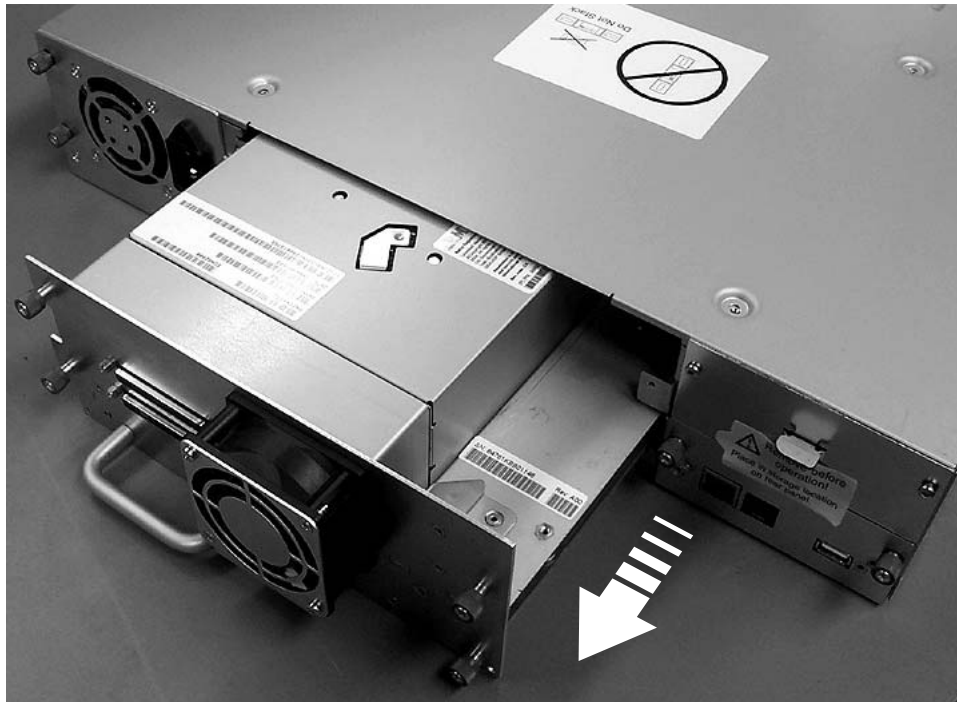

Figure 10-16. Removing a drive sled from the library (drive sled without ESD springs shown)

1. Ensure the power cord is unplugged from the power source for each Power Supply in the defective library enclosure.
2. On the rear of the defective library, loosen the blue captive thumbscrews on the drive sled.
3. If necessary, remove the conductive tape from the drive sled.
4. Pull back on the tape drive handle to remove it from the library.
5. On the rear of the replacement library enclosure, extend the black pull-out tab located underneath the lower right corner of the lowest drive sled position. Ensure that the black pull-out tab remains extended when inserting a drive sled in the lowest drive position in the library.

**Important: Damage to the connector pins may occur if this procedure is not followed.**

6. Place each tape drive into the replacement library enclosure in the same drive slot as it was positioned in the defective library.
  - While supporting the drive assembly, align the drive sled with the groove in the drive slot rails.
  - Slowly push the drive sled forward until it is properly seated.
7. Tighten the captive thumbscrews until the drive is secure.
8. If installing a drive sled without ESD springs (see Figure 10-16), apply conductive tape as shown in Figure 10-17 on page 10-18.

## 2U Library

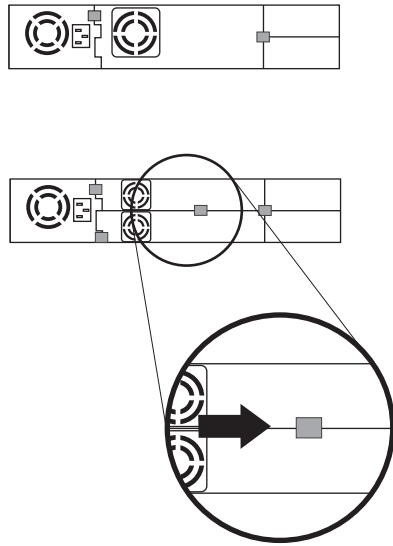

## 4U Library

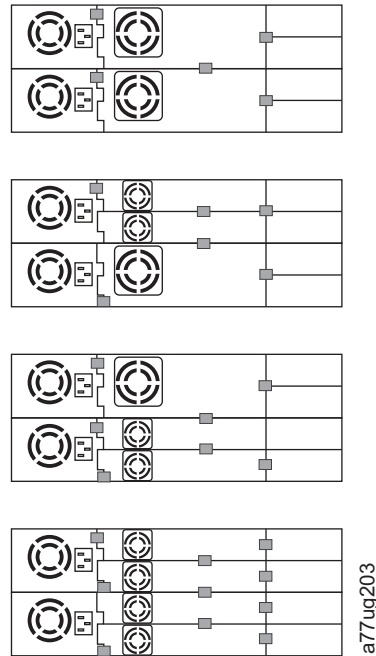

a77ug203

Figure 10-17. Drive sled taping diagrams

**Note:** The gray markers show where conductive tape should be placed.

9. Push the black tab back underneath the drive sled. When inserted properly, only the handle of the tab will be visible.

## Power Supplies

1. Unplug the power cord from the power source if this was not done previously (see “Installing Your Drive(s) in the Replacement Library Enclosure” on page 10-16).
2. .
  - a. To remove a power supply from a library:
    - 1) Loosen the three blue captive thumbscrews on the power supply.
    - 2) Pull on two of the thumbscrews, on opposite sides of the power supply, and pull the unit away from the rear panel of the library.
    - 3) Grasp the top and bottom edges of the power supply and remove it from the library.
  - b. To install a power supply:
    - 1) While supporting the power supply, align the power supply with the groove in the enclosure rails.
    - 2) Push the power supply forward until it is properly seated.
    - 3) Tighten the thumbscrews.



Figure 10-18. A power supply being removed from a library

## Library Controller Card

### IMPORTANT - READ ME BEFORE CONTINUING

The Library Enclosure contains a copy of the vital product data (VPD) for your library. The VPD contains your current library configuration. A primary copy of this VPD is contained within the Library Controller Card. A backup copy of this VPD is maintained on the accessor in the enclosure (or chassis). When the Library Enclosure is replaced, the new enclosure electronics should contain zeros (0's) in key VPD locations. Upon detection of these zeros, the library will automatically write VPD data to the replacement library enclosure from the primary copy of the VPD contained in the Library Controller Card.

If the message "VPD Selection" is displayed at the Operator Control Panel, carefully highlight the "VPD from Controller" option before selecting OK. This will copy VPD from the controller to the replacement library enclosure.

the Library Controller Card the defective library in the replacement library enclosure.

1. Remove the Library Controller Card (see Figure 10-19 on page 10-20) in the defective library. To remove a Library Controller Card:
  - a. Loosen the two blue captive thumbscrews on the Library Controller Card.
  - b. Grasp the thumbscrews and pull the card out of the library.
2. Install the Library Controller Card from the defective library in the replacement library enclosure. To install a Library Controller Card:
  - a. Grasp the Library Controller Card faceplate and align the Library Controller Card with the groove in the enclosure rails.
  - b. Push the Library Controller Card forward until it is properly seated.

**Note:** You will hear a snap when the Library Controller Card is fully engaged and installed properly.

- c. Tighten the thumbscrews.



Figure 10-19. Removing a Library Controller Card from the library

## Swapping Cartridge Magazines

1. Manually release and remove all magazines from the defective library from the replacement library enclosure. To release and remove a cartridge magazine:
  - a. Find the access holes for the right and left magazines (see Figure 10-20 and Figure 10-21 on page 10-21).



Figure 10-20. Access hole for the left magazine (facing rear of library)

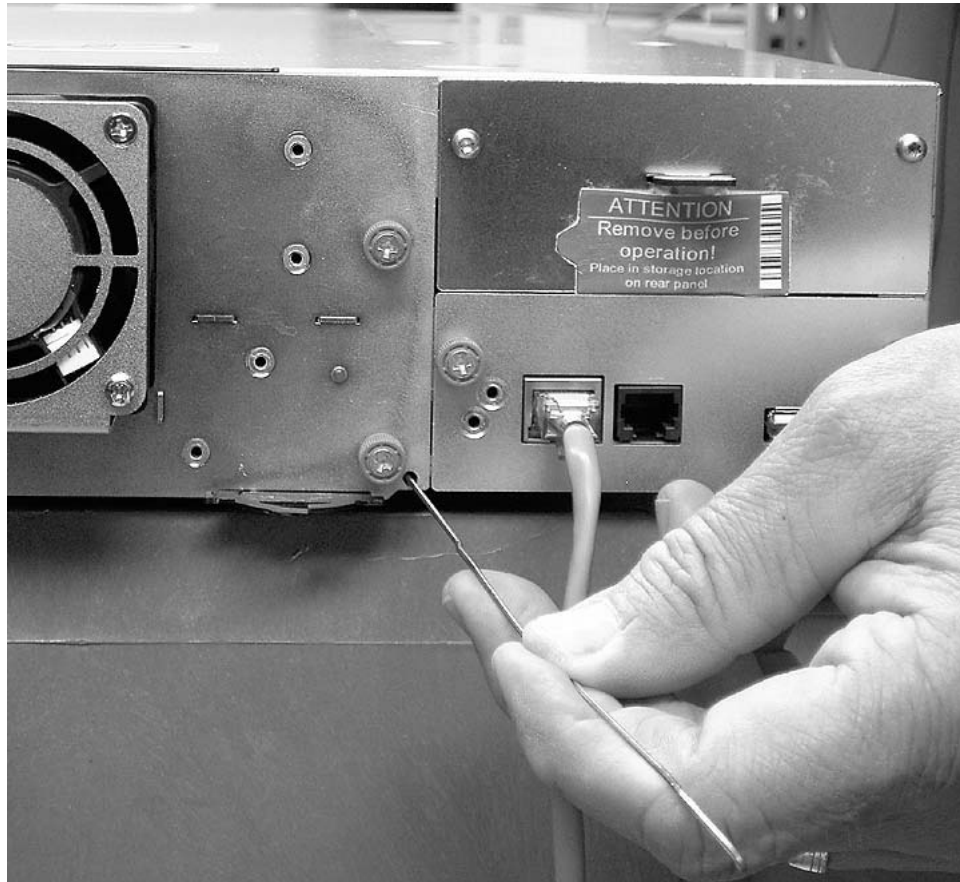

Figure 10-21. Access hole for the right magazine (facing rear of library)

- b. Push the end of a straightened paper clip into the access hole for each magazine at the back of the library. **DO NOT push the paper clip in more than  $\frac{1}{2}$  inch.** While holding the paper clip, have a second person pull the magazine out from the front of the unit.

**Note:** To prevent dropping the magazine, support both ends of the magazine before it clears the front edge of the library.



Figure 10-22. Left magazines pulled out of a 4U library (facing front of library)

2. Insert the cartridge magazines removed from the defective library into the same positions in the replacement library enclosure.
3. Insert the cartridge removed from the replacement library enclosure into the same positions in the defective library.

## Installing the Replacement Library Enclosure

Refer to the appropriate procedure in this section (rack or desktop) for installing the replacement library enclosure.

### Rack Installation:

1. Remove the mounting brackets ( **1** in Figure 10-23 on page 10-23) and anchors ( **2** ) from each side of the defective library and install them on the replacement library enclosure.



Figure 10-23. Mounting brackets and anchors for securing the library in a rack (one bracket and anchor on each side of the library)

2. With assistance, slide the replacement library enclosure onto the metal rails that are already in position in the rack (see Figure 10-24).

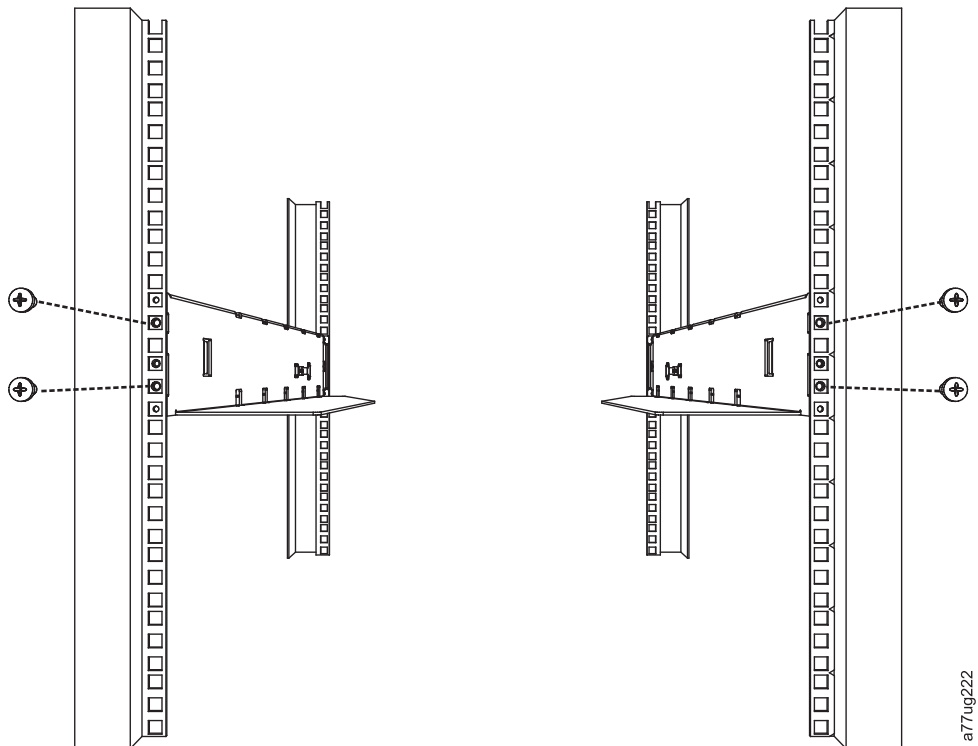

Figure 10-24. Front view of rack showing screw placement

3. Tighten the mounting bracket screws ( **1** in Figure 10-12 on page 10-14) to anchor the replacement library enclosure to the rack.
4. Proceed to “Completing the Installation of the Replacement Library Enclosure” on page 10-24.

**Desktop Installation:**

1. Place the library in its permanent location.
2. Proceed to “Completing the Installation of the Replacement Library Enclosure.”

**Completing the Installation of the Replacement Library Enclosure**

1. Connect all cables to the replacement library enclosure.
2. Power ON the replacement library enclosure.
3. Upgrade library firmware and drive firmware to the latest version.
  - a. Visit <http://www.support.dell.com/> to download the latest levels of library and drive firmware.
  - b. Using the Web User Interface (**Service Library** → **Upgrade Firmware**), upgrade library and drive firmware.
4. Run the Library Verify test (Operator Control Panel: **Service** → **Library Verify**). This diagnostic requires a blank or scratch data cartridge.
5. Proceed to “Returning the Defective Library Enclosure.”

**Returning the Defective Library Enclosure**

1. Remove the shipping label ( **2** in Figure 10-15 on page 10-16) and lock ( **1** ) from the rear panel of the defective library, place the lock in the slot located in the top center of the library, and secure with the shipping lock label. This will secure the library accessor for shipping.
2. Using the replacement library enclosure packaging materials, securely package the defective library (including the removed from the replacement library enclosure) and return it, to Dell.

**Important:** Failure to return all of these components to Dell will result in you being charged for any missing components.



---

## Appendix A. SCSI Element Types, SCSI Addresses, and Physical Configurations

For an overview of library partitioning and element addressing, see “Library Partitioning and Element Addressing” on page A-3.

The following tables contain element addresses for the 2U library and the 4U library.

*Table A-1. 2U library SCSI Element Types and Element Addresses*

Element Type	Element Address Range
Media Transport (Accessor) Element (MTE)	1 (0x01)
I/O Station Element (IEE)	16 (0x10)
Data Transfer (Drive) Element (DTE)	256 (0x100), 257 (0x101)
Storage Elements (STE)	4096 (0x1000) - 4118 (0x1016)

*Table A-2. 4U library SCSI Element Types and Element Addresses*

Element Type	Element Address Range
Media Transport (Accessor) Element (MTE)	1 (0x01)
I/O Station Elements (IEE)	16 (0x10), 17 (0x11), 18 (0x12)
Data Transfer (Drives) Elements (DTE)	256 (0x100), 257 (0x101), 258 (0x102), 259 (0x103)
Storage Elements (STE)	4096 (0x1000) - 4140 (0x102C)

---

### 2U Library I/O Slot, Storage Slots and Drive Slot Element Addresses and Physical Locations

For an overview of library partitioning and element addressing, see “Library Partitioning and Element Addressing” on page A-3.

The following table contains the physical location and SCSI element address (decimal and hexadecimal) of the I/O slot, storage slots, and drive slot in the 2U library configured with one drive and one logical partition. If a second drive were installed, it would be located at address 257 (0x101).

With two drives installed, the library can be configured as one partition (with two drives) or as two partitions (with one drive per partition).

When configured with two drives and one logical partition, the Element Address assignments will be as follows: DTE assignments

- Drive 1: 256 (0x100)
- Drive 2: 257 (0x101)

The STE assignments will be as shown in Table A-3 on page A-2.

When configured with two drives and one logical partition, the Element Address assignments will be as follows:

DTE assignments

- Logical Library 1: Drive 1: 256 (0x100)
- Logical Library 2: Drive 2: 256 (0x100)

STE assignments

- Logical Library 1: Slot 1 through slot 11 4096 (x1000) through 4106 (0x100A)
- Logical Library 2: Slot 12 through slot 23 4096 (x1000) through 4107 (0x100B)

Table A-3. 2U library SCSI element addresses for storage slots and drive slot (one logical partition with one drive)

Left Magazine ← Front of 2U library				Library Rear Panel	Right Magazine Front of 2U library ⇒			
Slot 8 4103 (0x1007)	Slot 9 4104 (0x1008)	Slot 10 4105 (0x1009)	Slot 11 4106 (0x100A)	Drive 1 256 (0x100)	Slot 23 4118 (0x1016)	Slot 22 4117 (0x1015)	Slot 21 4116 (0x1014)	Slot 20 4115 (0x1013)
Slot 4 4099 (0x1003)	Slot 5 4100 (0x1004)	Slot 6 4101 (0x1005)	Slot 7 4102 (0x1006)		Slot 19 4114 (0x1012)	Slot 18 4113 (0x1011)	Slot 17 4112 (0x1010)	Slot 16 4111 (0x100F)
I/O slot 16 (0x10)	Slot 1 4096 (0x1000)	Slot 2 4097 (0x1001)	Slot 3 4098 (0x1002)		Slot 15 4110 (0x100E)	Slot 14 4109 (0x100D)	Slot 13 4108 (0x100C)	Slot 12 4107 (0x100B)

## 4U Library I/O Slots, Storage Slots, and Drive Slots Element Addresses and Physical Locations

For an overview of library partitioning and element addressing, see “Library Partitioning and Element Addressing” on page A-3.

The following table contains the physical location (Slot x) and SCSI element address in decimal (4xxx) and in hexadecimal (0x10xx) of the I/O slots, storage slots, and drive slots in the 4U library containing only two drive sleds.

In older 4U libraries where the Dedicated Cleaning Slot (DCS) is in a fixed location (slot 9) and elected to be retained as a DCS (option to delete DCS is available in library firmware greater than 1.95), the above slot numbering and element address changes starting with slot 10. In 4U libraries with a DCS, the information shown in slot 9 below moves to slot 10 and so forth through the remaining magazine slots. The final slot is slot 44 instead of slot 45 for libraries without a DCS. See “Configuring I/O Stations and Reserving Slots” on page 5-65 for information on how to delete the dedicated cleaning slot. Once the DCS is deleted, you cannot get it back. You will have to create a reserved slot if you want to clean the drive(s).

Table A-4. 4U library SCSI element addresses for storage slots and drive slot (one logical partition with drives in slot 1 and slot 2)

Upper Left Magazine ←Front of 4U library	Library Rear Panel	Upper Right Magazine Front of 4U library⇒
---	-----------------------	--

Table A-4. 4U library SCSI element addresses for storage slots and drive slot (one logical partition with drives in slot 1 and slot 2) (continued)

<b>Slot 18</b> 4113 (0x1011)	<b>Slot 19</b> 4114 (0x1012)	<b>Slot 20</b> 4115 (0x1013)	<b>Slot 21</b> 4116 (0x1014)	<b>Drive 2</b> 257 (0x101)	<b>Slot 45</b> 4140 (0x102C)	<b>Slot 44</b> 4139 (0x102B)	<b>Slot 43</b> 4138 (0x102A)	<b>Slot 42</b> 4137 (0x1029)
<b>Slot 14</b> 4109 (0x100D)	<b>Slot 15</b> 4110 (0x100E)	<b>Slot 16</b> 4111 (0x100F)	<b>Slot 17</b> 4112 (0x1010)		<b>Slot 41</b> 4136 (0x1028)	<b>Slot 40</b> 4135 (0x1027)	<b>Slot 39</b> 4134 (0x1026)	<b>Slot 38</b> 4133 (0x1025)
<b>Slot 10</b> 4105 (0x1009)	<b>Slot 11</b> 4106 (0x100A)	<b>Slot 12</b> 4107 (0x100B)	<b>Slot 13</b> 4108 (0x100C)		<b>Slot 37</b> 4132 (0x1024)	<b>Slot 36</b> 4131 (0x1023)	<b>Slot 35</b> 4130 (0x1022)	<b>Slot 34</b> 4129 (0x1021)
<b>Lower Left Magazine</b>				<b>Drive 1</b> 256 (0x100)	<b>Lower Right Magazine</b>			
<b>I/O Slot 3</b> 18 (0x12)	<b>Slot 7</b> 4102 (0x1006)	<b>Slot 8</b> 4103 (0x1007)	<b>Slot 9</b> 4104 (0x1008)		<b>Slot 33</b> 4128 (0x1020)	<b>Slot 32</b> 4127 (0x101F)	<b>Slot 31</b> 4126 (0x101E)	<b>Slot 30</b> 4125 (0x101D)
<b>I/O Slot 2</b> 17 (0x11)	<b>Slot 4</b> 4099 (0x1003)	<b>Slot 5</b> 4100 (0x1004)	<b>Slot 6</b> 4101 (0x1005)		<b>Slot 29</b> 4124 (0x101C)	<b>Slot 28</b> 4123 (0x101B)	<b>Slot 27</b> 4122 (0x101A)	<b>Slot 26</b> 4121 (0x1019)
<b>I/O Slot 1</b> 16 (0x10)	<b>Slot 1</b> 4096 (0x1000)	<b>Slot 2</b> 4097 (0x1001)	<b>Slot 3</b> 4098 (0x1002)		<b>Slot 25</b> 4120 (0x1018)	<b>Slot 24</b> 4119 (0x1017)	<b>Slot 23</b> 4118 (0x1016)	<b>Slot 22</b> 4117 (0x1015)

## Library Partitioning and Element Addressing

Library 4U systems with firmware versions of .80 and higher, and containing at least 2 drives, have the ability to configure two logical libraries (create two partitions). This partitioning has been expanded with the new library firmware and half-high drive integration. Now it is possible to configure 1, 2, 3 or 4 partitions in the 4U library. Additionally the 2U library can now be configured into one or two partitions. Each library must contain at least one drive per logical library (partition). In a partitioned library, the Operator Control Panel (OCP) only reports the status of logical library 1 in the main menu due to space limitations. You must navigate to the logical libraries status in the OCP to get the information on the additional library partitions.

### Partitioning of 2U Libraries

When two half height drives are installed in a 2U library, the library firmware will support partitioning in the same way that the 4U supports partitioning with two full height drives today. The first partition will contain the first magazine and the first drive. The second partition will contain the second magazine and the second drive. The I/O station (if configured as I/O) will be shared, as is done with the partitioned 4U library.

One full height drive is "Drive 1". When using half height drives, the first half height drive position will be called "Drive 1", The second half height drive position will be called "Drive 2."

### Partitioning of 4U Libraries

When one or more half height drives are added to a 4U library, the drive naming will change. Currently, the first full height drive is "Drive 1" and the second full height drive is "Drive 2". When you consider that each full height drive slot may contain one or two half height drives, there are four potential drives in the space

that used to occupy two. As a result, the first half height drive position, or the first full-high drive position, will be called "Drive 1". The second half height drive position will be called "Drive 2". The third half height drive position, or the second full height drive position, will be called "Drive 3". The fourth half height drive position will be called "Drive 4".

**Important:** In a 4U library a full height drive sled may be installed in drive slot 1 (drive will occupy slot 1 and slot 2) or drive slot 3 (drive will occupy slot 3 and slot 4). A full height drive sled should never be installed in drive slot 2 (drive will occupy slot 2 and slot 3).

## Mixing of Drives

The library will support a mix of full height and half height drives in the same physical library and the same logical library. They will support a mix of Gen 3, Gen 4, and Gen 5 drives in the same physical library and the same logical library. They will also support a mix of SCSI, SAS, and Fibre Channel in the same physical library and the same logical library; however, mixing drive interface types in the same logical library is not recommended.

## Configuration of a 1 - Partition System

A one partition system configured for a 4U library contains any and all drives present in any drive positions, and it will contain all four magazines. When configured with one logical partition, the Element Address assignments will be as follows: DTE assignments will be as shown in Figure A-1

STE assignments

- Logical Library 1: Slot1 through 23 4096 (0x1000) through 4118 (0x1016) as shown in Figure A-4 on page A-6

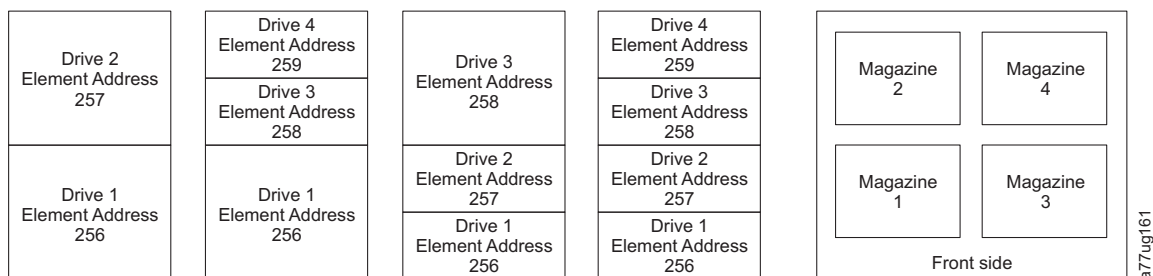

Figure A-1. Configuration of a one - partition system

## Configuration of a 2 - Partition System

A two partition system must have a minimum of two drives, but may have three or four drives. Partition 1 will contain any drives in drive position 1 and drive position 2. Partition 1 will also contain magazine 1 and magazine 2. Partition 2 will contain any drives in drive position 3 and drive position 4. Partition 2 will also contain magazine 3 and magazine 4.

When configured with two logical partitions, the Element Address assignments will be as follows: DTE assignments will be as shown in Figure A-2 on page A-5.

STE assignments

- Logical Library 1: Slot 1 through slot 21 4096 (x1000) through 4116 (0x1014)
- Logical Library 2: Slot 22 through slot 45 4096 (x1000) through 4019 (0x1017)

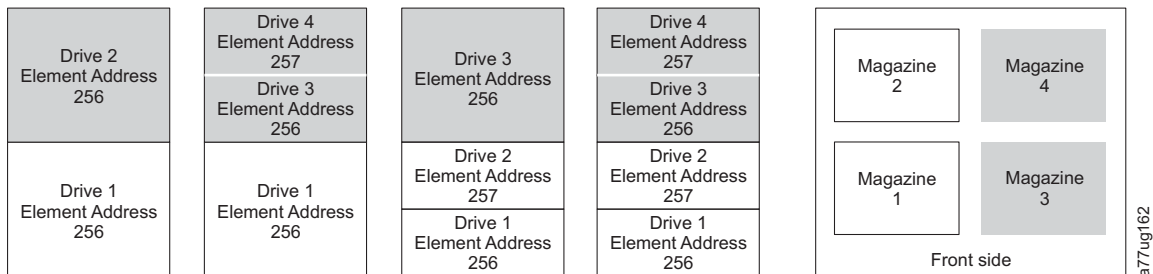

Figure A-2. Configuration of a two - partition system

### Configuration of a 3 - Partition System

A three partition system must have at least three drives installed. A drive must be installed in drive position 1, another drive must be installed in drive position 2, and another drive must be installed in either drive position 3 or drive position 4. Partition 1 will contain the first drive and the first magazine. Partition 2 will contain the second drive and the second magazine. Partition 3 will contain any drives in drive position 3 and drive position 4. Partition 3 will also contain magazine 3 and magazine 4.

STE assignments

- Logical Library 1: Slot 1 through slot 9 4096 (x1000) through 4104 (0x1008)
- Logical Library 2: Slot 10 through slot 21 4096 (x1000) through 4107 (0x100B)
- Logical Library 3: Slot 22 through slot 45 4096 (x1000) through 4119 (0x1017)

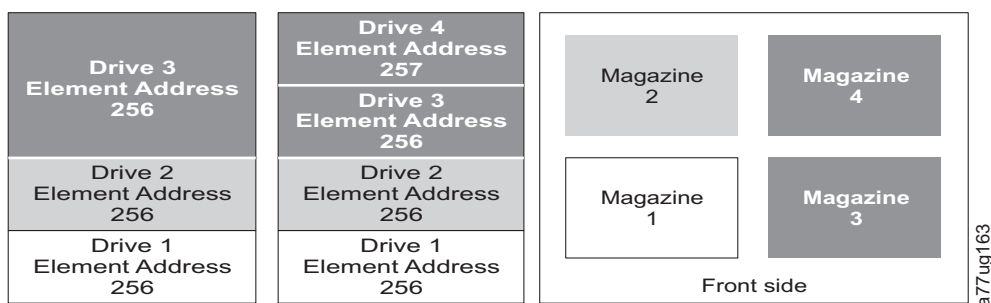

Figure A-3. Configuration of a three - partition system

### Configuration of a 4 - Partition System

A four partition system must have four drives. Each partition will contain one drive and one magazine.

When configured with four logical partitions, the Element Address assignments will be as follows: DTE assignments will be as shown in Figure A-4 on page A-6.

STE assignments

- Logical Library 1: Slot 1 through slot 9 4096 (x1000) through 4104 (0x1008)
- Logical Library 2: Slot 10 through slot 21 4096 (x1000) through 4107 (0x100B)

- Logical Library 3: Slot 22 through slot 33 4096 (x1000) through 4107 (0x100B)
- Logical Library 4: Slot 34 through slot 45 4096 (x1000) through 4107 (0x100B)

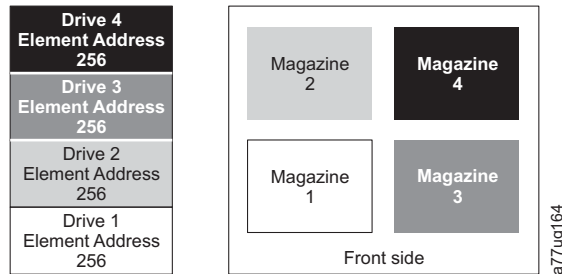

Figure A-4. Configuration of a four - partition system

### SCSI Element Addressing

Every logical library starts at the first drive slot with the current assigned element start address (default value 256). It will be incremented from the bottom to the top slots for every drive slot. There is one exception to this addressing scheme to accommodate libraries currently in the field. A 4U library which contains only full height drives will continue to have the addresses assignments 256 and 257, thus causing no interruptions to their operation. Drive slots will still be incremented by 1 for each drive slot position.

**Note:** Exchanging drives with different form factors will result in the library needing to be reconfigured.

4U Unit with only FH drives  
(1 logical library)

SCSI Element	Slot
257	4
	3
256	2
	1

4U Unit with FH and HH drives  
(1 logical library)

SCSI Element	Slot
258	4
	3
257	2
256	1

Figure A-5. Examples of SCSI element addressing

The SCSI specification does not allow gaps in the SCSI element addressing. Special handling is needed for empty drive slots to fulfill the specification. Also temporarily removed drives need to have their addresses preserved to not confuse the attached host and host application. Generally only drives which are currently physically available or temporarily removed are reported. Empty (unused) slots located at the bottom or the top should not be reported, with an exception in case of a "removed" condition. A drive slot which does not contain a drive, and has a

position between used slots, needs to be reported as a SCSI element. To signal the host application that this slot is not usable, its ACCESS bit will be disabled.

**Note:** When reducing the number of drives in your library, update the Logical Library configuration. This will remove the Attention LED on the front panel and the exclamation mark on the Home screen indicating that a drive is missing.

Updating the Logical Library configuration will also update the drive element addressing and drive numbering. Replacing LTO half height drives with full height drives may require you to execute Restore Factory Defaults to correctly update the drive element addressing and drive numbering. See “Configure Library: Save/Restore Configuration” on page 5-56.





---

## Appendix B. TapeAlert Flags

*This appendix is intended to provide additional information to the reader about the tape drive. All error code and diagnostic information contained in this chapter can be accessed from the Operator Control Panel of the Library. The drive portion of the Operator Control Panel Display will contain any drive error codes. Therefore there is no need to open the Library to access the buttons on the drive as described in this chapter.*

TapeAlert is a standard that defines status conditions and problems experienced by devices such as tape drives, autoloaders, and libraries. The standard enables a server to read TapeAlert messages (called *flags*) from a tape drive via the SCSI bus. The server reads the flags from Log Sense Page 0x2E.

This library is compatible with TapeAlert technology, which provides error and diagnostic information about the drives and the library to the server. Because library and drive firmware may change periodically, the SNMP interface in the library does not require code changes if devices add additional TapeAlerts that are not supported today. However, should this occur the Management Information Block (MIB) is written to minimize impact to the SNMP monitoring station. At the time of this writing, the TapeAlert flags in this appendix correctly represent TapeAlerts that will be sent. The MIB file should not be taken to mean that all traps that are defined in the MIB (refer to Appendix F, "SNMP Status MIB Variables and Traps," on page F-1) will be sent by the library or that they will be sent in the future.

This appendix lists TapeAlert flags that are supported by the Ultrium 3 and Ultrium 4 Tape Drives.

---

### TapeAlert Flags Supported by the Library

Parameter Code	Flag name	Type	Description
01d	Library Hardware A	C	The media changer mechanism is having difficulty communicating with the drive: <ul style="list-style-type: none"><li>• Turn the library OFF then ON</li><li>• Restart the operation</li></ul> If problem persists, contact Technical Support.
02d	Library Hardware B	W	There is a problem with the media changer mechanism. If the problem persists, contact Technical Support.
03d	Library Hardware C	C	The media changer has a hardware fault: <ul style="list-style-type: none"><li>• Make sure the media changer and drives are not being used by any host, then reset the library from the front panel.</li><li>• If the problem persists, contact Technical Support.</li></ul>
04d	Library Hardware D	C	<ul style="list-style-type: none"><li>• Make sure the media changer and drives are not being used by any host, then reset the library from the front panel.</li><li>• If the problem persists, contact Technical Support.</li></ul>

13d	Library Pick Retry	W	<p>There is a potential problem with the cartridge loader picking a cartridge from a drive or slot.</p> <ul style="list-style-type: none"> <li>• No action needs to be taken at this time.</li> <li>• If the problem persists, contact Technical Support</li> </ul> <p>This flag is cleared when the next move command is received.</p>
14d	Library Place Retry	W	<p>There is a potential problem with the cartridge loader placing a cartridge into a slot.</p> <ul style="list-style-type: none"> <li>• No action needs to be taken at this time.</li> <li>• If the problem persists, contact Technical Support.</li> </ul> <p>This flag is cleared when the next move command is received.</p>
15d	Drive Load Retry	W	<p>There is a potential problem with the cartridge loader or drive when placing a cartridge into a drive.</p> <ul style="list-style-type: none"> <li>• No action needs to be taken at this time.</li> <li>• If the problem persists, contact Technical Support.</li> </ul> <p>This flag is cleared when the next move command is received.</p>
16d	Library Door	W	<p>The operation has failed because the library door is open.</p> <ul style="list-style-type: none"> <li>• Clear any obstructions from the library door.</li> <li>• Close the library door.</li> <li>• If the problem persists, contact Technical Support.</li> </ul> <p>This flag is cleared when the door is closed.</p>
17d	Library I/O Station	C	There is a mechanical problem with the library media I/O Station.
19d	Library Security	W	Library security has been compromised. The door was opened then closed during operation.
24d	Library Inventory	C	<p>The library has detected an inconsistency in its inventory.</p> <ul style="list-style-type: none"> <li>• Redo the library inventory to correct inconsistency.</li> <li>• Restart the operation.</li> </ul> <p>Check the applications users manual or the hardware users manual for specific instructions on redoing the library inventory.</p>
27d	Cooling FAN Failure	W	One or more fans inside the library have failed. This flag is cleared when all fans are working again.
32d	Unreadable Bar Code Labels	I	The library was unable to read the barcode on a cartridge.
<ul style="list-style-type: none"> <li>• I = Informational suggestion to user</li> <li>• W = Warning. Remedial action is advised. Performance of data may be at risk.</li> <li>• C = Critical immediate remedial action is required.</li> </ul>			

## TapeAlert Flags Supported by the Drive

Table B-1. TapeAlert Flags Supported by the Ultrium Tape Drive

Flag Number	Flag	Description	Action Required
3	Hard error	Set for any unrecoverable read, write, or positioning error. (This flag is set in conjunction with flags 4, 5, or 6.)	See the Action Required column for Flag Number 4, 5, or 6 in this table.

Table B-1. TapeAlert Flags Supported by the Ultrium Tape Drive (continued)

Flag Number	Flag	Description	Action Required
4	Media	Set for any unrecoverable read, write, or positioning error that is due to a faulty tape cartridge.	Replace the tape cartridge.
5	Read failure	Set for any unrecoverable read error where isolation is uncertain and failure could be due to a faulty tape cartridge or to faulty drive hardware.	If Flag 4 is also set, the cartridge is defective. Replace the tape cartridge.
6	Write failure	Set for any unrecoverable write or positioning error where isolation is uncertain and failure could be due to a faulty tape cartridge or to faulty drive hardware.	If Flag Number 9 is also set, make sure that the write-protect switch is set so that data can be written to the tape (see "Write-Protect Switch" on page 6-6). If Flag Number 4 is also set, the cartridge is defective. Replace the tape cartridge.
7	Media life	Set when the tape cartridge reaches its end of life (EOL).	<ol style="list-style-type: none"> <li>1. Copy the data to another tape cartridge.</li> <li>2. Discard the old (EOL) tape.</li> </ol>
8	Not data grade	Set when the cartridge is not data-grade. Any data that you write to the tape is at risk.	Replace the tape with a data-grade tape.
9	Write protect	Set when the tape drive detects that the tape cartridge is write-protected.	Ensure that the cartridge's write-protect switch is set so that the tape drive can write data to the tape (see "Write-Protect Switch" on page 6-6).
10	No removal	Set when the tape drive receives an UNLOAD command after the server prevented the tape cartridge from being removed.	Refer to the documentation for your server's operating system.
11	Cleaning media	Set when you load a cleaning cartridge into the drive.	No action required.
12	Unsupported format	Set when you load an unsupported cartridge type into the drive or when the cartridge format has been corrupted.	Use a supported tape cartridge.
15	Cartridge memory chip failure	Set when a cartridge memory (CM) failure is detected on the loaded tape cartridge.	Replace the tape cartridge.
16	Forced eject	Set when you manually unload the tape cartridge while the drive was reading or writing.	No action required.
17	Media loaded is Read-only format	Set when a cartridge marked as read only is loaded into the drive. The flag is cleared when the cartridge is ejected.	No action required.
18	Tape directory corrupted in the cartridge memory	Set when the drive detects that the tape directory in the cartridge memory has been corrupted.	Re-read all data from the tape to rebuild the tape directory.

Table B-1. TapeAlert Flags Supported by the Ultrium Tape Drive (continued)

Flag Number	Flag	Description	Action Required
19	Nearing media life	Set when the tape cartridge is nearing its specified end of life. The flag is cleared when the cartridge is removed from the drive.	<ol style="list-style-type: none"> <li>1. Copy the data to another tape cartridge.</li> <li>2. Replace the tape cartridge.</li> </ol>
20	Clean now	Set when the tape drive detects that it needs cleaning.	Clean the tape drive.
21	Clean periodic	Set when the drive detects that it needs routine cleaning.	Clean the tape drive as soon as possible. The drive can continue to operate, but you should clean the drive soon.
22	Expired clean	Set when the tape drive detects a cleaning cartridge that has expired.	Replace the cleaning cartridge.
23	Invalid cleaning tape	Set when the drive expects a cleaning cartridge and the loaded cartridge is not a cleaning cartridge.	Use a valid cleaning cartridge.
30	Hardware A	Set when a hardware failure occurs that requires that you reset the tape drive to recover.	
31	Hardware B	Set when the tape drive fails its internal Power-On Self Tests.	Note the error code on the single-character display, then
32	Interface	Set when the tape drive detects a problem with the host interface.	
33	Eject media	Set when a failure occurs that requires you to unload the cartridge from the drive.	Unload the tape cartridge, then reinsert it and restart the operation.
34	Download fail	Set when an FMR image is unsuccessfully downloaded to the tape drive through the host interface.	Ensure that it is the correct FMR image. Download the FMR image again.
37	Drive voltage	Set when the drive detects that the externally supplied voltages are either approaching the specified voltage limits or are outside the voltage limits.	
38	Predictive failure of drive hardware	Set when a hardware failure of the tape drive is predicted.	
39	Diagnostics required	Set when the drive detects a failure that requires diagnostics for isolation.	
51	Tape directory invalid at unload	Set when the tape directory on the tape cartridge that was previously unloaded is corrupted. The file-search performance is degraded.	Use your backup software to rebuild the tape directory by reading all the data.
52	Tape system area write failure	Set when the tape cartridge that was previously unloaded could not write its system area successfully.	Copy the data to another tape cartridge, then discard the old cartridge.
53	Tape system area read failure	Set when the tape system area could not be read successfully at load time.	Copy the data to another tape cartridge, then discard the old cartridge.

Table B-1. TapeAlert Flags Supported by the Ultrium Tape Drive (continued)

Flag Number	Flag	Description	Action Required
55	Loading Failure	When loading a tape into a drive, a hardware malfunction can prevent the tape from being loaded into the drive, or the tape may actually get stuck in the drive.	<p>Take this action if the tape cartridge will not load in the drive:</p> <ol style="list-style-type: none"> <li>1. Remove the tape cartridge from the library and inspect it for damage. If damaged, discard it.</li> <li>2. Try another cartridge in that tape drive. If it still fails, replace the drive sled. See "Removing/Installing/Adding a Tape Drive Sled" on page 10-3.</li> </ol> <p>Take this action if the tape is stuck in the drive:</p> <ol style="list-style-type: none"> <li>1. Attempt to unload the tape from the drive using the host backup application that is currently using the drive, or using the remote or local UI.</li> <li>2. If the cartridge will not unload, contact technical support.</li> </ol>
56	Unload Failure	When attempting to unload a tape cartridge, a drive hardware malfunction can prevent the tape from being ejected. The tape may actually be stuck in the drive.	<ol style="list-style-type: none"> <li>1. Unload the cartridge from the drive using the Operator Control Panel (<b>Control</b> → <b>Move Cartridge</b>) or the Web User Interface (<b>Manage Library</b> → <b>Move Media</b>).</li> <li>2. Cycle drive power using the Operator Control Panel (<b>Service</b> → <b>Service</b> → <b>Drive Power</b>) or the Web User Interface (<b>Configure Library</b> → <b>Drives</b>).</li> <li>3. Try unloading the cartridge from the drive again using the Operator Control Panel (<b>Control</b> → <b>Move Cartridge</b>) or the Web User Interface (<b>Manage Library</b> → <b>Move Media</b>).</li> <li>4. If the cartridge will not unload from the drive, contact technical support.</li> </ol>
59	WORM Medium – integrity check failed	Set when the drive determines that the data on tape is suspect from a WORM point of view.	<ol style="list-style-type: none"> <li>1. Copy the data to another WORM tape cartridge.</li> <li>2. Discard the old WORM tape.</li> </ol>
60	WORM Medium – Overwrite attempted	Set when the drive rejects a write operation because the rules for allowing WORM writes have not been met. Data can only be appended to WORM media. Overwrites to WORM media are not allowed.	Append the information on a WORM tape cartridge or write the data to a non-WORM cartridge.



---

## Appendix C. Sense Data

When a drive encounters an error, it makes sense data available. You can use device drivers to examine the sense data and determine errors. The device drivers may conflict with some commercial software applications unless properly configured. To avoid conflicts on Windows operating systems, refer to your device driver's procedures for setting the driver to manual startup mode.

If your application uses other device drivers, see the appropriate documentation for those drivers to obtain the sense data.

In addition to device drivers, other methods exist for obtaining sense data and error information. The sections that follow describe alternatives for gathering such information.

---

### Library Sense Data

The following table lists the Additional Sense Codes (ASC) and Additional Sense Code Qualifiers (ASCQ) associated with the reported Sense Keys.

A sense key of 00h (no sense) has no ASC/ASCQ associated with it. A few ASC/ASCQs can be associated with more than one sense key. The sense keys that can give a particular ASC/ASCQ are indicated within the Sense Key column. ASC/ASCQs that can indicate an abnormal element state as part of element descriptor.

*Table C-1. Library Sense Keys, ASC and ASCQ*

Sense Key	ASC	ASCQ	Description
Recovered Error (01)	0Ah	00h	Error log overflow
	47h	00h	SCSI parity error
Not Ready (02)	00h	17h	Drive cleaning requested
	04h	00h	Cause not reportable
	04h	01h	In progress becoming ready, scanning magazines, etc.
	04h	02h	Initializing command required
	04h	03h	Manual intervention required
	04h	07h	Operation in progress
	04h	12h	Offline
	04h	83h	Door open
	04h	85h	Firmware upgrade in progress
	04h	87h	The drive is not enabled
	04h	88h	The drive is busy
	04h	89h	The drive is not empty
	04h	9Ah	Drive fibre down
	04h	8Eh	The media changer is in sequential mode
	30h	03h	Cleaning in progress
	3Bh	12h	Magazine removed

Table C-1. Library Sense Keys, ASC and ASCQ (continued)

Sense Key	ASC	ASCQ	Description
Medium Error (03)	30h	00h	Incompatible media installed
	30h	03h	Cleaning tape installed
	30h	07h	Cleaning failure



Table C-1. Library Sense Keys, ASC and ASCQ (continued)

Sense Key	ASC	ASCQ	Description
Hardware Error (04)	81h	80h	Cannot initialize bar code reader
	81h	81h	No response from bar code reader
	81h	82h	No response from EEPROM
	81h	83h	Slave robotic generic problem
	81h	84h	Setting of gripper pic value failed
	81h	85h	Setting of slider pic value failed
	81h	86h	Setting of elevator pic value failed
	81h	87h	Setting of rotation pic value failed
	81h	88h	Setting of sled pic value failed
	81h	89h	Gripper blocked
	81h	8Ah	Slider blocked
	81h	8Bh	Elevator blocked
	81h	8Ch	Rotation blocked
	81h	8Dh	Sled blocked
	81h	8Eh	Cannot find gripper block
	81h	8Fh	Cannot find slider block
	81h	90h	Cannot find elevator block
	81h	91h	Cannot find rotation block
	81h	92h	Cannot find sled block
	81h	93h	Gripper outside range
	81h	94h	Slider outside range
	81h	95h	Elevator outside range
	81h	96h	Rotation outside range
	81h	97h	Sled outside range
	81h	98h	No cartridge present sensor found
	81h	99h	No slider home sensor found
	81h	9Ah	No rotation home sensor found
	81h	9Bh	No sled position sensor found
	81h	9Ch	The range of gripper is wrong
	81h	9Dh	The range of slider is wrong
	81h	9Eh	The range of elevator is wrong
	81h	9Fh	The range of rotation is wrong
	81h	A0h	The range of sled is wrong
	81h	A1h	Open import/export element failed
81h	A2h	Locking failed	
81h	A3h	SE2 Block	
81h	A4h	SE2 No Block	
81h	A5h	No Sled2 Home Sensor	
81h	A6h	No Elev Home Sensor	

Table C-1. Library Sense Keys, ASC and ASCQ (continued)

Sense Key	ASC	ASCQ	Description
Hardware Error (04) (continued)	81h	B0h	Slave robotic controller response timeout
	81h	B1h	NACK received from slave robotic controller
	81h	B2h	Slave robotic controller communication failed
	81h	B3h	Slave robotic controller urgent stop
	81h	B4h	Cartridge did not transport completely
	81h	B5h	Slave robotic controller does not respond on command
	80h	C0h	Network init
	80h	C1h	Telnet interface
	80h	C2h	Webserver
	80h	C3h	EEPROM parameter
	80h	C4h	Cannot init LAN card
	80h	C5h	Write to EEPROM failed
	80h	C6h	Ping command did not reach target
	80h	C7h	Cannot upgrade from USB
	80h	D0h	ROM error
	80h	D1h	RAM error
	80h	D2h	NVRAM error
	80h	D3h	CTC error
	80h	D4h	UART error
	80h	D5h	Display error
	80h	D6h	Memory error
	80h	D7h	Fatal system error
	80h	D8h	dBase error
	80h	D9h	No SCSI IC detected
	80h	DAh	Different bar code labels
	80h	DBh	External cooling fan failure
	80h	DCh	Internal I2C bus error
	80h	DFh	Power Good failed
	80h	E0h	Incompatible Magazine
	82h	F0h	Over temperature problem
	82h	F1h	Drive communication error
	82h	F2h	Drive sled not present
	82h	F3h	Drive broken: needs repair
	82h	F4h	Drive load timeout
	82h	F5h	Drive unload timeout
	82h	F6h	Drive never present
	82h	F7h	Drive support ticket error

Table C-1. Library Sense Keys, ASC and ASCQ (continued)

Sense Key	ASC	ASCQ	Description
Illegal Request (05h)	1Ah	00h	Parameter length error
	20h	00h	Invalid command operation code
	21h	01h	Invalid element address
	24h	00h	Invalid field CDB
	3Dh	00h	SCSI invalid ID message
	25h	00h	Invalid LUN
	2Ch	00h	Command sequence error
	26h	00h	Invalid field in parameter list
	26h	01h	Parameter list error: parameter not supported
	26h	02h	Parameter value invalid
	26h	90h	Wrong firmware image, does not fit boot code
	26h	91h	Wrong personality firmware image
	26h	93h	Wrong firmware image, checksum error
	39h	00h	Saving parameters not supported
	3Bh	0Dh	Medium destination element full
	3Bh	0Eh	Medium source element empty
	3Bh	11h	Medium magazine not accessible
	3Bh	81h	Cartridge of other partition
	3Bh	A0h	Medium transfer element full
	53h	02h	Library media removal prevented state set
	53h	03h	Drive media removal prevented state set
	44h	80h	Bad status library controller
	44h	81h	Source not ready
	44h	82h	Destination not ready
	44h	83h	Cannot make reservation
	44h	84h	Wrong drive type
	44h	85h	Invalid slave robotic controller request
	44h	86h	Accessor not initialized
Unit Attention (06h)	28h	00h	Not ready to ready transition
	28h	01h	Import/export element accessed
	29h	01h	Power on occurred
	29h	02h	SCSI Bus reset occurred
	29h	05h	Bus type changed to Single Ended (SE)
	29h	06h	Bus type changed to Low Voltage Differential (LVD)
	2Ah	01h	Mode parameters changed
	2Ah	10h	Time stamp changed
	3Bh	13h	Medium magazine inserted
	3Fh	01h	Microcode has changed
	53h	02h	Media removal prevented

Table C-1. Library Sense Keys, ASC and ASCQ (continued)

Sense Key	ASC	ASCQ	Description
Command Aborted (0Bh)	3Fh	0Fh	ECHO buffer overwritten
	43h	00h	SCSI message error
	47h	00h	SCSI parity error
	49h	00h	SCSI invalid message
	4Eh	00h	Overlapped command attempt

## Drive Sense Data

LTO Ultrium 4 drives contain hardware which performs user data write encryption and read decryption, protecting all user data written to the medium from unauthorized use, provided it is integrated into a secure system design.

Table C-2. LTO Tape Drive Sense Data

Byte	Bit Address or Name							
	7	6	5	4	3	2	1	0
0	Address valid  When set to 1, the info byte field contains a valid logical block address.	Error Code						
1	Segment Number (0)							
2	Filemark	EOM (end of medium)	ILI (Incorrect length indicator)	Reserved	Sense Key Description 0 - No sense 1 - Recovered error 2 - Not ready 3 - Media error 4 - Hardware error 5 - Illegal request 6 - Unit attention 7 - Data protect 8 - Blank Check 9 - Reserved A - Reserved B - Aborted command C - Reserved D - Volume overflow E - Reserved F - Reserved			
3	Information byte (most significant byte)							
4	Information byte							
5	Information byte							
6	Information byte (least significant byte)							
7	Additional Sense Length							
8-11	Command specific information							

Table C-2. LTO Tape Drive Sense Data (continued)

Byte	Bit Address or Name							
	7	6	5	4	3	2	1	0
12-13	Additional Sense Code (ASC) Additional Sense Code Qualifier (ASCQ) <b>Byte 12 Byte 13</b> <b>ASC ASCQ</b>							
00	00	00 - No additional sense - The flags in the sense data indicate the reason for the command failure						
00	01	01 - Filemark detected - A Read or Space command terminated early due to an FM. The FM flag is set.						
00	02	02 - EOM - A Write or Write File Marks command failed because the physical end of tape was encountered, or a Read or Space command encountered EOM. The EOM flag is set						
00	04	04 - BOM - A space command ended at Beginning of Tape. The EOM bit is also set						
00	05	05 - EOD - Read or Space command terminated early because End of Data was encountered						
00	16	16 - Operation in Progress						
04	00	00 - Cause not reportable - A cartridge is present in the drive, but it is in the process of being unloaded						
04	01	01 - Becoming Ready - A media access command was received during a front panel initiated load or an immediate reported load command						
04	02	02 - Initializing Command Required - A cartridge is present in the drive, but is not logically loaded. A Load command is required						
04	03	03 - Manual Intervention Required - A cartridge is present in the drive but could not be loaded or unloaded without manual intervention						
04	10	10 - Logical unit not ready, auxiliary memory not accessible						
04	12	12 - Logical unit not ready, offline						
08	01	01 - Logical unit communication failure						
09	00	00 - Track following error (servo)						
0C	00	00 - Write Error - A Write operation has failed. This is probably due to bad media, but may be hardware related						
11	00	00 - Unrecovered Read Error - A Read operation failed. This is probably due to bad media, but may be hardware related						
11	12	12 - Auxiliary memory read error. The drive reported that it is unable to read the Auxiliary Memory in a WORM cartridge.						
14	00	00 - Recorded Entity Not Found - A space or Locate command failed because a format violation prevented the target from being found.						
14	03	03 - End Of Data not found - A Read type operation failed because a format violation related to a missing EOD data set						
14	10	10 - Not Ready - Auxiliary memory not accessible. The drive is not able to become ready because it is unable to access the Auxiliary Memory in a WORM cartridge.						
17	01	01 - Recovered data with retries						
1A	00	00 - Parameter list length error - The amount of parameter data sent is incorrect						
20	00	00 - Invalid Command Operation Code - The Operation Code in the command was not a valid Operation Code						
24	00	00 - Invalid field in CDB - An invalid field has been detected in a Command Descriptor Block						
25	00	00 - LUN not supported - The command was addressed to a non-existent logical unit number						
26	00	00 - Invalid Field in Parameter List - An invalid field has been detected in the data sent during the data phase						

Table C-2. LTO Tape Drive Sense Data (continued)

Byte	Bit Address or Name							
	7	6	5	4	3	2	1	0
12-13	Additional Sense Code (ASC) - Additional Sense Code Qualifier (ASCQ) (Continued)							
	<b>Byte 12 Byte 13</b>							
	<b>ASC ASCQ</b>							
27	00	- Write Protect - A Write type operation has been requested on a cartridge which has been write protected						
28	00	- Not Ready to Ready Transition - A cartridge has been loaded successfully into the drive and is now ready to be accessed						
28	01	- Import or export element accessed						
29	00	- Reset - The drive has powered on, received a reset signal or a bus device reset signal since the initiator last accessed it						
29	04	- Device internal reset						
2A	01	- Mode Parameters Changed - The Mode parameters for the drive have been changed by an initiator other than the one issuing the command						
2C	00	- Command sequence error						
2C	0B	- Not reserved - The OIR bit of the sequential access device page is set and the I-T nexus attempting to communicate with the drive does not hold a reservation.						
2F	00	- Commands cleared by another initiator						
30	00	- Incompatible Media Installed - A write type operation could not be executed because it is not supported on the cartridge type that is loaded.						
30	01	- Unknown Format - An operation could not be carried out because the cartridge in the drive is of a format not supported by the drive						
30	02	- Incompatible Format - An operation could not be completed because the Logical Format is not correct						
30	03	- Cleaning Cartridge Installed - An operation could not be carried out because the cartridge in the drive is a cleaning cartridge						
30	05	- Cannot write medium, incompatible format						
30	07	- Cleaning Failure - A cleaning operation was attempted, but could not be completed for some reason						
30	0C	- Data Protect - WORM overwrite attempted. The drive rejected a write operation because it would have resulted in an overwrite. Overwrite is not allowed on WORM media.						
30	0D	- Medium Error - WORM integrity check. The drive rejected a Read or Write operation because the cartridge is a suspicious WORM cartridge.						
31	00	- Media format corrupted - Data could not be read because the format on tape is not valid, but is a known format. A failure occurred attempting to write the FID						
37	00	- Rounded parameter - A Mode Select command parameter has been rounded because the drive can not store it with the accuracy of the command.						
3A	00	- Media Not Present - A media access command has been received when there is no cartridge loaded						
3B	00	- Sequential Positioning Error - A command has failed and left the logical position at an unexpected location						
3B	0C	- Position past beginning of medium						
3D	00	- Invalid bits in identify Message - An illegal Identify Message has been received at the drive at the start of a command						
3E	00	- Logical Unit has not Self-Configured - The drive has just powered on and has not completed its self test sequence and can not process commands						
3F	01	- Code Download - The firmware in the drive has just been changed by a Write Buffer command						
3F	03	- Inquiry data has changed						
3F	0E	- Reported LUNs data has changed						
3F	0F	- Echo buffer overwritten						
40	xx	- Diagnostic failure - A diagnostic test has failed. The xx (ASCQ) is a vendor specific code indicating the failing component.						

Table C-2. LTO Tape Drive Sense Data (continued)

Byte	Bit Address or Name							
	7	6	5	4	3	2	1	0
12-13	Additional Sense Code (ASC) - Additional Sense Code Qualifier (ASCQ) (Continued)							
	<b>Byte 12 Byte 13</b>							
	<b>ASC ASCQ</b>							
41	00	- Data path failure						
43	00	- Message Error - A message could not be sent or received due to excessive transmission errors						
44	00	- Internal target failure - A hardware failure has been detected in the drive that has caused the command to fail						
45	00	- Select/Reset Failure - An attempt to reselect an initiator in order to complete the command has failed						
48	00	- Initiator detected error message received						
49	00	- Invalid message error						
4A	00	- Command phase error						
4B	00	- Data Phase Error - A command could not be completed because too many parity errors occurred during the Data phase						
4E	00	- Overlapped Commands - An initiator selected the drive even though it already had a command outstanding in the drive						
50	00	- Write Append Error - A write type command failed because the point at which to append data was unreadable						
51	00	- Erase failure - An Erase command failed to erase the required area on the media						
52	00	- Cartridge fault - A command could not be completed due to a fault in the tape cartridge						
53	00	- Media Load/Eject Failed - (Sense Key 03) An attempt to load or eject the cartridge failed due to a problem with the cartridge.						
53	00	- Media Load/Eject Failed - (Sense Key 04) An attempt to load or eject the cartridge failed due to a problem with the drive						
53	02	- Media Removal Prevented - An Unload command has failed to eject the cartridge because media removal has been prevented						
5A	01	- Operator medium removal request						
5D	00	- Failure Prediction Threshold - Failure Prediction thresholds have been exceeded indicating that a failure may occur soon						
5D	FF	- Failure Prediction False - A Mode Select command has been used to test for Failure Prediction system.						
82	82	- Drive requires cleaning - The drive has detected that a cleaning operation is required to maintain good operation						
82	83	- Bad Code Detected - The data transferred to the drive during a firmware upgrade is corrupt or incompatible with drive hardware						

Table C-2. LTO Tape Drive Sense Data (continued)

Byte	Bit Address or Name							
	7	6	5	4	3	2	1	0
12-13	Additional Sense Code (ASC) - Additional Sense Code Qualifier (ASCQ) (Continued) <b>Byte 12    Byte 13</b> <b>ASC        ASCQ</b>  <b>Sense Key 0 (No Sense)</b> EE     13 - Encryption - Key Translate EF     13 - Encryption - Key Translate EKM  <b>Sense Key 3 (Medium Error)</b> 30     02 - Encryption - Encryption feature is not enabled so format/processing is not supported EE     60 - Encryption - Proxy Command Error EE     D0 - Encryption - Data Read Decryption Failure EE     D1 - Encryption - Data Read after Write Decryption Failure EE     E0 - Encryption - Key Translation Failure EE     E1 - Encryption - Key Translation Ambiguous EE     F0 - Encryption - Decryption Fenced (Read) EE     F1 - Encryption - Encryption Fenced (Write)  <b>Sense Key 4 (Hardware Error)</b> EE     0E - Encryption - Key Service Timeout EE     0F - Encryption - Key Service Failure 40     00 - Encryption - Failure Hardware, POST or Module Failure  <b>Sense Key 5 (Illegal Request)</b> EE     00 - Encryption - Key Service Not Enabled EE     01 - Encryption - Key Service Not Configured EE     02 - Encryption - Key Service Not Available EE     10 - Encryption - Key Required EE     20 - Encryption - Key Count Exceeded EE     21 - Encryption - Key Alias Exceeded EE     22 - Encryption - Key Reserved EE     23 - Encryption - Key Conflict EE     24 - Encryption - Key Method Change EE     25 - Encryption - Key Format Not Supported EE     26 - Encryption - Unauthorized Request - dAK EE     27 - Encryption - Unauthorized Request - dSK EE     28 - Encryption - Unauthorized Request - eAK EE     29 - Encryption - Authentication Failure EE     2A - Encryption - Invalid RDKi EE     2B - Encryption - Key Incorrect EE     2C - Encryption - Key Wrapping Failure EE     2D - Encryption - Sequencing Failure EE     2E - Encryption - Unsupported Type EE     2F - Encryption - New Key Encrypted Write Pending EE     30 - Encryption - Prohibited Request EE     31 - Encryption - Key Unknown EE     32 - Encryption - Keystore Related Problem EE     42 - Encryption - EKM Challenge Pending EE     E2 - Encryption - Key Translation Disallowed EE     FF - Encryption - Security Prohibited Function EF     01 - Encryption - Key Service Not Configured 26     11 - Encryption - Incomplete Key - Associate Data Set 26     12 - Encryption (T10) - Vendor Specific Reference Key Not Found 55     08 - Encryption (T10) - Maximum Number of Supplemental Keys Exceeded							



Table C-2. LTO Tape Drive Sense Data (continued)

Byte	Bit Address or Name							
	7	6	5	4	3	2	1	0
12-13	<b>Sense Key 6 (Unit Attention)</b> EE 12 - Encryption - Key Change Detected EE 18 - Encryption - Changed (Read) EE 19 - Encryption - Changed (Write) EE 40 - Encryption - EKM Identifier Changed EE 41 - Encryption - EKM Challenge Changed EE 50 - Encryption - Initiator Identifier Changed EE 51 - Encryption - Initiator Response Changed 2A 11 - Encryption - Data Encryption Parameters Changed by Another I_T Nexus 2A 12 - Encryption - Data Encryption Parameters Changed by Vendor Specific Event  <b>Sense Key 7 (Data Protect)</b> EF 10 - Encryption - Key Required EF 11 - Encryption - Key Generation EF 13 - Encryption - Key Translate EF 1A - Encryption - Key Optional EF C0 - Encryption - No Operation 26 10 - Encryption - Data Decryption Key Fail Limit 2A 13 - Encryption - Data Encryption Key Instance Counter Has Changed 74 00 - Security Error 74 01 - Encryption - Unable to Decrypt Data 74 02 - Encryption - Unencrypted Data Encountered While Decrypting 74 03 - Encryption - Incorrect Data Encryption Key 74 04 - Encryption - Cryptographic Integrity Validation Failed 74 05 - Encryption - Error Decrypting Data							
14	FRU code							
15	SKSV	C/D	Reserved		BPV	Bit pointer		
					When set to 1, the bit pointer is valid.			
16 -17	SKSV = 0: First Error Fault Symptom Code (FSC). SKSV = 1: Field Pointer							
18-19	First Error Flag Data							
20	Reserved (0)							
21					CLN	Reserved	Reserved	VolValid
22-28	Volume Label							
29	Current Wrap							
30-33	Relative LPOS							
34	SCSI Address							
35	Frame number				Drive number			

Table C-2. LTO Tape Drive Sense Data (continued)

Byte	Bit Address or Name							
	7	6	5	4	3	2	1	0
36-39	<p>Port Identifier (Relative Target Port Address) Reporting Sense (This is the port address of the drive port through which sense is being reported.)</p> <p>On Fibre Channel drives, it is the Fibre Channel Fabric Port Address [for example, 011E13 or 000026] with byte 36 being reserved.</p> <p>On SAS drives, it is the Hashed SAS Address of the drive port [for example, F32A94] with byte 36 being reserved.</p> <p>On SCSI, bytes 36 through 38 are reserved, and byte 39 is set to the port's SCSI address [i.e., byte 39 = byte 34].)</p>							
40	Tape Directory Valid	Reserved	Reserved	Reserved	Reserved	Relative Tgt Port Reporting Sense 0: Reserved 1: Relative Tgt Port 1 (Port 0) 2: Relative Tgt Port 2 (Port 1) 3: Relative Tgt Port 3 (Library Port)		
41	Host Command (SCSI Opcode)							
42	Density Type 0: No media present 1: Gen1 (384 track) 2: Gen2 (512 track) 3: Gen3 (704 track)				Media Type (Vendor Reserved)			
43	Volume Label Cartridge Type							
44								
45-48	Logical Block Number (Current LBA that would be reported in Read Position command)							
49-52	Data set Number							
53	1st Error FSC							
54								
55	1st Error Flag Data							
56								
57	2nd Error FSC							
58								
59	2nd Error Flag Data							
60								
61	Next-to-Last Error FSC							
62								
63	Next-to-Last Error Flag Data							
64								

Table C-2. LTO Tape Drive Sense Data (continued)

Byte	Bit Address or Name							
	7	6	5	4	3	2	1	0
65	Last Error FSC							
66								
67	Last Error Flag Data							
68								
69	LPOS Region							
70-85	ERP Summary Information							
86-89	Product Revision Level: YMDV (as defined in Standard Inquiry; this is also known as the Code Level)							
90-95	Reserved (0)							

The descriptions below serve only as an overview of sense reporting in the tape drive. This tape drive conforms to all sense field reporting as specified in the SCSI standards.

**Note:**

1. The Error Code field (Byte 0) is set to 70h to indicate a current error, that is one associated with the most recently received command. It is set to 71h to indicate a deferred error which is not associated with the current command.
2. The segment number (Byte 1) is zero since the Copy, Compare, and Copy and Verify commands are not supported.
3. The File Mark flag (Byte 2, bit 7) is set if a Space, Read, or Verify command did not complete because a file mark was read.
4. The End of Media (EOM) flag (Byte 2, bit 6) is set if a Write or Write File Marks command completed in the early warning area. Spacing into BOM also causes this flag to be set. It is also set on an attempt to read or space past EOD, or if an attempt is made to space into Beginning of Media.
5. The Illegal Length Indicator (ILI) flag (Byte 2, bit 5) is set if a Read or Verify ended because a block was read from tape that did not have the block length requested in the command.
6. The Information Bytes (Bytes 3-5) are only valid if the Valid flag is set. This occurs only for current errors and not for deferred errors.
7. The Field Replaceable Unit field (Byte 14) is set to either zero or to a non-zero, vendor-specific code indicating which part of the drive is suspected of causing the failure.
8. The Clean (CLN) flag (Byte 21, bit 3) is set if the drive needs cleaning and clear otherwise.
9. The Volume Label Fields Valid (VolValid) bit (Byte 21, bit 0) is set if the Volume Label being reported is valid.
10. The Volume Label field (Bytes 22-28) reports the volume label if a cartridge is loaded in the drive and Volume Label Fields Valid is set.
11. The Current Wrap field (Byte 29) reports the physical wrap of the tape. The least significant bit reflects the current physical direction. A 0

means that the current direction is away from the physical beginning of the tape. A 1 means that the current direction is towards the physical beginning of the tape.

12. Relative LPOS fields (Bytes 30-33) reports the current physical position on the tape.
13. SCSI Address field (Byte 34) reports the SCSI Bus Address for the drive. Values returned range from 00h to 0Fh.
14. This field (Byte 35) contains the frame and drive number, passed across the RS-422 serial interface.

---

## Appendix D. Enabling LUN Support in Linux

To verify the detection of a tape drive, administrators should check for its entry in `/proc/scsi/scsi`. Current versions of Linux may not scan the logical storage unit (LUN) ID of every device. This can result in some TL2000/TL4000 devices not being identified or listed in the `/proc/scsi/scsi` output. Administrators can follow these steps to enable support for such devices.

1. Type `cat /proc/scsi/scsi`. The output will look similar to the following:

```
Attached devices:
Host: scsi0 Channel: 00 Id: 01 Lun: 00
  Vendor:  IBM Model: ULT3580-HH3   Rev: 88M3
  Type:    Sequential-Access ANSI SCSI revision: 03
```

2. Identify the host adapter, channel number, target ID number, and LUN number for the first LUN of the device to be configured. In this example, the IBM Model ULT3580 (a drive in the TL2000/TL4000) is shown at the address, or nexus, 0 0 0 0 — which means host adapter 0, channel number 0, ID 1, and LUN 0. The TL2000/TL4000 always has the tape drive at LUN 0 and the robot at LUN 1.
3. For each LUN that needs to be discovered by Linux, issue the following command: `echo "scsi-add-single-device H C I L">/proc/scsi/scsi H C I L` refers to the nexus described in step 2. So, with the TL2000/TL4000 robot configured at LUN 1, type: `echo "scsi-add-single-device 0 0 1 0">/proc/scsi/scsi`. The echo command will force a scan of each device at the given nexus.
4. Type `cat /proc/scsi/scsi` again to verify that all devices are now listed. The output will look similar to the following:

```
Attached devices:
Host: scsi0 Channel: 00 Id: 01 Lun: 00
  Vendor:  IBM Model: ULT3580-HH3   Rev: 88M3
  Type:    Sequential-Access ANSI SCSI revision: 03

Attached devices:
Host: scsi0 Channel: 00 Id: 02 Lun: 01
  Vendor:  IBM Model: 3573-TL   Rev: 7.10
  Type:    Medium Changer ANSI SCSI revision: 05
```

Administrators should add the echo command to the Linux boot scripts because the device information is not persistent and must be created each time the system boots up. One example file that can be used for storing the commands is `/etc/rc.local`. Note that configuring additional devices on a server or a storage area network (SAN) can cause the devices to be reordered, which requires administrators to modify the commands. If the Fibre Channel adapter supports Persistent Bindings or an equivalent function, it can be enabled to reduce the chance of devices being reordered upon discovery.

**Note:** This procedure must be run each time the server is booted. Also, if backup application services are running (for example, they automatically start when the OS loads), they must be disabled and re-enabled after the above procedure.

The other way to enable LUN support is to recompile the kernel and enable LUN scanning in the Adaptec driver, but it requires advanced knowledge of Linux and will not be covered here. However, it will allow the server to always boot and see the device without any manual procedures.

---

## Red Hat Enterprise Linux

RHEL doesn't automatically probe all LUNs on SCSI devices. The symptom shows LUN 0, which would be the drive, but not the loader.

1. Type `#cat /proc/scsi/scsi`.

```
Attached devices:
Host: scsi0 Channel: 00 Id: 06 Lun: 00
  Vendor: IBM Model: ULT3580-HH3 Rev: 88M3
  Type:   Sequential-Access   ANSI SCSI revision: 03
```

2. You will need to add the following to `/etc/modules.conf`

```
options scsi_mod max_scsi_luns=255
```

**Note:** In RHEL 4, it is `max_luns=255`

3. Once that's added, you will have to rebuild the `initrd` and reboot the server. There is a way to test this before editing the files and rebooting, but there's too much of a risk of taking down other SCSI devices in the process. Rebuilding the `initrd` will be the tricky part. You have to know exactly which kernel version you want to use to do this properly. You can find out the kernel version by using the `uname` command.

```
#uname -r
2.4.9-e.38
```

**Note:** There is a list of known kernel versions on the Red Hat Enterprise Linux page.

4. So, given the version is 2.4.9-e.38

```
# cp /boot/initrd-2.4.9-e.38.img /boot/initrd-2.4.9-e.38.img.bak
# mkinitrd -f -v /boot/initrd-2.4.9-e.38.img 2.4.9-e.38
```

This should give some output, then go to a new prompt. If it gives any errors, check the syntax you put into `/etc/modules.conf` or contact someone knowledgeable with Linux.

5. If successful, the server WILL need to be rebooted. Once it comes back up, check `/proc/scsi/scsi` again.

```
#cat /proc/scsi/scsi
Attached devices:
Host: scsi0 Channel: 00 Id: 06 Lun: 00
  Vendor: IBM Model: ULT3580-HH3   Rev: 88M3
  Type:   Sequential-Access   ANSI SCSI revision: 03
Host: scsi0 Channel: 00 Id: 06 Lun: 01
  Vendor: IBM   Model: 3573-TL     Rev: 7.10
  Type:   Medium Changer         ANSI SCSI revision: 05
```

---

## Enabling LUN Support in Netware

1. From the System Console, verify the LUN device is not being detected by using the `list storage adapters` command. Typical output where only the tape drive is being recognized:

```
0x08 [V321-A3] Adaptec SCSI Card 39160/3960D - Ultra160 SCSI [slot 201]
  0x15 [V321-A3-D5:0] IBM ULT3580-TD3 5BG2
0x09 [V321-A4] Adaptec SCSI Card 39160/3960D - Ultra160 SCSI [slot 202]
```

2. From the System Console, type `nwconfig`.
3. Select **NCF files Options** from the Configuration Options screen.
4. Select **Edit STARTUP.NCF** from the Available NCF Files Options screen.

5. Add the /LUNS switch to the load line of the appropriate SCSI driver. If a dual channel card is installed and you are unsure which channel the LUN device is attached to, simply edit both lines.

```
LOAD ADPT160M.HAM SLOT=201 /LUNS
LOAD ADPT160M.HAM SLOT=202 /LUNS
```

6. After the STARTUP.NCF file has been edited, save the file and reboot the server to activate the new STARTUP.NCF.
7. Upon reboot navigate to the System Console and type scan all. This will start a scan of all the LUNS on each adapter.
8. When the scan is complete, verify the LUN device has been detected using the list storage adapters command. Typical output with both the tape drive and loader being recognized:

```
0x08 [V321-A3] Adaptec SCSI Card 39160/3960D - Ultra160 SCSI [slot 201]
  0x16 [V321-A3-D5:1] DELL PV-124T 0031
  0x15 [V321-A3-D5:0] IBM ULT3580-TD3 5BG2
0x09 [V321-A4] Adaptec SCSI Card 39160/3960D - Ultra160 SCSI [slot 202]
```

Netware may display **unbound device**, meaning a driver is not bound to the loader unless a driver from a backup software is loaded. This does not prevent the backup application from detecting the LUN and binding the appropriate driver.

**Note:** The command **scan all** must be typed upon OS boot every time. If backup software services automatically start on OS boot, you must disable them, run the scan all command, and re-enable the services.





---

## Appendix E. Notes on IPv6 Compatibility with Windows 2003/XP and 2008/Vista

IPv6 addressing is different from traditional IPv4 addressing. IPv4 addressing is listed in the format 255.255.255.255, with each value 1 byte, a total address of 4 bytes. IPv6 addresses require 16 bytes, and are listed in the format FFFF:FFFF:FFFF:FFFF:FFFF:FFFF:FFFF:FFFF, where there are 8 segments each 2 bytes long.

### Windows 2003/XP

IPv6 support in Windows 2003 is not turned on by default. Use the following instructions to enable IPv6 support.

1. Go to **Control Panel** → **Network Connections**, and right-click on the Local Area Connection interface that is to be enabled with IPv6 support.
2. Select **Properties** from the drop-down menu, and the **Local Area Connection Properties** window should open. Click on the **Install** button.
3. In the new **Select Network Component Type** window, select **Protocol** and click on the **Add** button.
4. In the **Select Network Protocol** window, select **Microsoft TCP/IP version 6** and click on the **OK** button. IPv6 is now enabled.

Windows 2003 and XP comes with a WinINet API that does not fully support IPv6 literals. Upgrading to Internet Explorer 7 in Windows 2003 is recommended for IPv6 browser support as the WinINet API is updated with the installation of Internet Explorer 7. Third party browsers (such as Firefox) also use the WinINet API either directly or indirectly, so an upgrade to IE7 will be recommended for all users.

As multiple IPv6 addresses can be associated with one physical interface, Windows 2003 and XP use an interface number associated with each link-local IPv6 address that must be included for connectivity to any link-local IPv6 address. The interface number then must be appended to any outgoing IPv6 traffic; otherwise, the IPv6 packet does not know which logical interface to egress from.

The interface number can be determined through the command line of Windows.

1. Go to **Start** → **Run** and type **cmd** to enter the command prompt.
2. At the command prompt, type **ipconfig** and find the link-local IPv6 address. Appended to the end of this will be a %x where x is the interface number.

#### Browser connectivity to a global unicast IPv6 address

- Global unicast IPv6 addresses can be browsed to by entering this syntax into the browser address line: `HYPERLINK "http://[%3cIPv6_Global_Unicast_Address%3e]"/"http://<[IPv6_Global_Unicast_Address>]/`
- The IPv6 address must be enclosed in square brackets ("[]").

#### Browser connectivity to a link-local IPv6 address

- The IPv6 address cannot be entered into a browser window in the same way an IPv4 address is when connecting via a link-local IPv6 address.

- After upgrading the WinInet API (by upgrading to IE 7), the library RMU can be accessed from the browser by using the following format.
  - Replace all : with -.
  - Append s<interface#>.ipv6-literal.net to the end of the IPv6 address.
  - For example, if the IPv6 address is fe80::1234:5678:abc and the interface number is 13, the address to browse to would be http://fe80--1234-5678-abcs13.ipv6-literal.net.
- Using the same IPv6 address as above, another alternative to this would be to edit the hosts file in the <Windows Base Directory\system32\drivers\etc\ directory and add the following line: fe80::1234:5678:abc%13<hostname> .
  - The address to browse to would be HYPERLINK "http://%3chostrname%3e/"http://<hostname>
  - Note that the interface number can change with a reboot of the Windows host.

## Windows 2008/Vista

Windows 2008 and Vista natively support IPv6. Also, interface numbers have been removed from these versions of Windows. All that is needed to browse to an address would be to add brackets ([]) around the IPv6 address. Thus, if the TL2000/4000 IPv6 address is fe80::1234:5678:abc, enter http://[fe80::1234:5678:abc] into the browser window. This is applicable for both link-local and global unicast IPv6 addresses.

---

## Notes on IPv6 Compatibility with Linux

1. While IPv6 is supported under Linux, IPv6 literals for link-local addresses are not currently supported in Linux browsers, so the RMU will not be accessible in Linux via a link-local IPv6 address. Global unicast IPv6 addresses are supported in the same manner as in Windows 2008/Vista browsers.
2. The RMU is accessible through IPv4.

---

## Appendix F. SNMP Status MIB Variables and Traps

**Note:** For additional information, refer to “SNMP Messaging” on page 1-7.

*Table F-1. SNMP Status Events*

Event	Trap ID	Definition
Status Change	1	Library status has changed.
Door Open	2	Library door has been opened.
Mail Slot Accessed	3	Library I/O Station has been accessed.
Fault Posted	4	Library has posted a hard fault/error.
Request Drive Clean	5	Drive has requested a clean.
Drive Error	6	Drive has reported an error.
Loader Retries Excessive	7	Library has reported excessive load retries.
Loader OK	8	Library has resumed normal operations.
Account Password Change	9	Account password in the library has changed.
<b>Note:</b> Trap ID 9 requires library firmware level 8.0 or greater, and the latest SNMP MIB file.		
Configuration Change	10	Library or drive configuration has changed.
Library Login	11	Someone has logged into the library via the Web User Interface.
Library Logout	12	Someone has logged out of the library via the Web User Interface.
<b>Note:</b> Trap IDs 10, 11, and 12 require library firmware level 9.00 or greater and the latest SNMP MIB file.		



## Appendix G. Library Configuration Form

Use this form when planning your library configuration. Keep this document in a secure location and update it when changes are made to the library configuration.

General Information				
Library type	TL2000		TL4000	
Library Serial Number				
Library name				
I/O Station	Enabled		Disabled	
AutoClean	Enabled		Disabled	
Library Network Settings				
DHCP	Enabled		Disabled	
IP Address				
Netmask Address				
Gateway Address				
DNS Servers IP Addresses				
EKM Servers IP Addresses				
Encryption Settings				
Logical Libraries				
Number in library	1	2	3	4
Mode	Random: ON/OFF Sequential: ON/OFF Autoload: ON/OFF Loop: ON/OFF	Random: ON/OFF Sequential: ON/OFF Autoload: ON/OFF Loop: ON/OFF	Random: ON/OFF Sequential: ON/OFF Autoload: ON/OFF Loop: ON/OFF	Random: ON/OFF Sequential: ON/OFF Autoload: ON/OFF Loop: ON/OFF
Magazine Assignment	<input type="checkbox"/> Upper Left <input type="checkbox"/> Lower Left <input type="checkbox"/> Upper Right <input type="checkbox"/> Lower Right	<input type="checkbox"/> Upper Left <input type="checkbox"/> Lower Left <input type="checkbox"/> Upper Right <input type="checkbox"/> Lower Right	<input type="checkbox"/> Upper Left <input type="checkbox"/> Lower Left <input type="checkbox"/> Upper Right <input type="checkbox"/> Lower Right	<input type="checkbox"/> Upper Left <input type="checkbox"/> Lower Left <input type="checkbox"/> Upper Right <input type="checkbox"/> Lower Right
Number of Active Slots				
Drive Serial Numbers	4U Position 4: 4U Position 3: 2U/4U Position 2: 2U/4U Position 1:	4U Position 4: 4U Position 3: 2U/4U Position 2: 2U/4U Position 1:	4U Position 4: 4U Position 3: 2U/4U Position 2: 2U/4U Position 1:	4U Position 4: 4U Position 3: 2U/4U Position 2: 2U/4U Position 1:

<b>Drive types</b>	4U Position 4: 4U Position 3: 2U/4U Position 2: 2U/4U Position 1:	4U Position 4: 4U Position 3: 2U/4U Position 2: 2U/4U Position 1:	4U Position 4: 4U Position 4: 4U Position 3: 2U/4U Position 2: 2U/4U Position 1:4U Position 3: 2U/4U Position 2: 2U/4U Position 1:	4U Position 4:4U Position 3:2U/4U Position 2:2U/4U Position 1:
<b>Fibre Channel Drive settings</b>	Logical Library: Position: Speed: Port type: Loop ID:	Logical Library: Position: Speed: Port type: Loop ID:	Logical Library: Position: Speed: Port type: Loop ID:	Logical Library: Position: Speed: Port type: Loop ID:
<b>SAS Drive settings</b>	Logical Library: Position: ID:	Logical Library: Position: ID:	Logical Library: Position: ID:	Logical Library: Position: ID:
<b>SCSI Drive settings</b>	Logical Library: Position: ID:	Logical Library: Position: ID:	Logical Library: Position: ID:	Logical Library: Position: ID:
<b>User Accounts</b>				
Role: Password:				
Role: Password:				
Role: Password:				
Role: Password:				

---

## Appendix H. Accessibility

Accessibility features help a user who has a physical disability, such as restricted mobility or limited vision, to use the HTML version of the customer documentation successfully.

### Features

These are the major accessibility features for the HTML version of this document:

- You can use screen-reader software and a digital speech synthesizer to hear what is displayed on the screen. The following screen readers have been tested: WebKing and Window-Eyes.
- You can operate all features using the keyboard instead of the mouse.

### Navigating by keyboard

You can use keys or key combinations to perform operations and initiate many menu actions that can also be done through mouse actions. You can navigate the HTML version of the Dell PowerVault TL2000 Tape Library and TL4000 Tape Library User's Guide help system from the keyboard by using the following key combinations:

- To traverse to the next link, button, or topic, press Tab inside a frame (page).
- To move to the previous topic node, press ^ or Shift+Tab.
- To scroll all the way up or down, press Home or End, respectively.
- To print the current page or active frame, press Ctrl+P.
- To select, press Enter.

### Accessing the publications

You can view the publications for this library in Adobe Portable Document Format (PDF) using the Adobe Acrobat Reader. The PDFs are provided at the following Web site:

<http://support.dell.com>.





---

## Glossary

This glossary defines the special terms, abbreviations, and acronyms that are used in this publication. If you do not find the term you are looking for, refer to the index or to the *Dictionary of Computing*, 1994.

## Numbers

**2:1 compression.** The relationship between the quantity of data that can be stored with compression as compared to the quantity of data that can be stored without compression. In 2:1 compression, twice as much data can be stored with compression as can be stored without compression.

## A

**A.** Ampere.

**ac.** Alternating current.

**access method.** A technique for moving data between main storage and input or output devices.

**accessor.** This component contains the library robot and bar code reader. The accessor moves cartridges to and from the I/O Station, storage slots, and tape drives.

**adapter card.** A circuit board that adds function to a computer.

**adj.** Adjustment.

**alphanumeric.** Pertaining to a character set that contains letters, numerals, and usually other characters, such as punctuation marks.

**alter.** To change.

**ambient temperature.** The temperature of air or other media in a designated area, particularly the area surrounding equipment.

**ampere (A).** A unit of measure for electric current that is equivalent to a flow of one coulomb per second, or to the current produced by one volt applied across a resistance of one ohm.

**ANSI.** American National Standards Institute.

**archive.** To collect and store files in a designated place.

**ASCII.** American National Standard Code for Information Interchange. A 7 bit coded character set (8

bits including parity check) that consists of control characters and graphic characters.

**assigning a device .** The establishing of the relationship of a device to a running task, process, job, or program.

**assignment.** The naming of a specific device to perform a function.

**asynchronous.** Pertaining to two or more processes that do not depend upon the occurrence of specific events such as common timing signals.

**attention (notice).** A word for calling attention to the possibility of danger to a program, device, or system, or to data. Contrast with *caution* and *danger*.

**ATTN.** Attention.

## B

**backup.** To make additional copies of documents or software for safekeeping.

**bar code.** A code representing characters by sets of parallel bars of varying thickness and separation which are read optically by transverse scanning.

**bar code label.** Paper bearing a bar code and having an adhesive backing. The bar code label must be affixed to a tape cartridge to enable the library to identify the cartridge and its volume serial number.

**bar code reader.** A laser device specialized for scanning and reading bar codes and converting them into either the ASCII or EBCDIC digital character code.

**bezel.** Decorative and safety cover.

**bicolored.** Having two colors.

**bit.** Either of the digits 0 or 1 when used in the binary numbering system.

**BOM or bill of materials.** A list of specific types and amounts of direct materials expected to be used to produce a given job or quantity of output.

**browser.** A client program that initiates requests to a Web server and displays the information that the server returns.

**buffer .** A routine or storage used to compensate for a difference in rate of flow of data or time of occurrence of events, when transferring data from one device to another.

**bus.** A facility for transferring data between several devices located between two end points, only one device being able to transmit at a given moment.

**byte.** A string consisting of a certain number of bits (usually 8) that are treated as a unit and represent a character. A fundamental data unit.

## C

**capacity.** The amount of data that can be contained on storage media and expressed in bytes of data.

**cartridge storage slot.** Individual slot located within a magazine that is used to house tape cartridges.

**caution (notice).** A word to call attention to possible personal harm to people. Contrast with *attention* and *danger*.

**centimeter (cm).** One one-hundredth of a meter (0.01 m). Approximately 0.39 inch.

**channel command.** An instruction that directs a data channel, control unit, or device to perform an operation or set of operations.

**char.** Character.

**CHK.** Check.

**cleaning cartridge.** A tape cartridge that is used to clean the heads of a tape drive. Contrast with *data cartridge*.

**command.** A control signal that initiates an action or the start of a sequence of actions.

**compact disc (CD).** A disc, usually 4.75 inches in diameter, from which data is read optically by means of a laser.

**compression.** The process of eliminating gaps, empty fields, redundancies, and unnecessary data to shorten the length of records or blocks.

**concurrent.** Refers to diagnostic procedures that can be run on one control unit while the rest of the subsystem remains available for customer applications.

**contingent connection.** A connection between a channel path and a drive caused when a unit check occurs during an I/O operation.

**controller.** A device that provides the interface between a system and one or more tape drives.

**control path drive.** A drive that communicates messages from the host computer to the library in which the drive is installed.

**CP.** Circuit protector.

**ctrl.** Control.

**CU.** Control unit.

## D

**danger (notice).** A word to call attention to possible lethal harm to people. Contrast with *attention* and *caution*.

**data.** Any representations such as characters or analog quantities to which meaning is or might be assigned.

**data buffer.** The storage buffer in the control unit. This buffer is used to increase the data transfer rate between the control unit and the channel.

**data cartridge.** A tape cartridge dedicated to storing data. Contrast with *cleaning cartridge*.

**data check.** A synchronous or asynchronous indication of a condition caused by invalid data or incorrect positioning of data.

**dc.** Direct current.

**DCS.** Designated Cleaning Slot

**degauss.** To make a magnetic tape nonmagnetic by means of electrical coils carrying currents that neutralize the magnetism of the tape.

**degausser.** A device that makes magnetic tape nonmagnetic.

**degradation.** A decrease in quality of output or throughput or an increase in machine error rate.

**degraded.** Decreased in quality of output or throughput or increased machine error rate.

**deserialize.** To change from serial-by-bit to parallel-by-byte.

**detented.** A part being held in position with a catch or lever.

**device.** Any hardware component or peripheral, such as a tape drive or tape library, that can receive and send data.

**device driver.** A file that contains the code needed to use an attached device.

**DIAG .** Diagnostic section of maintenance information manual.

**differential.** See *High Voltage Differential (HVD)*.

**direct access storage.** A storage device in which the access time is independent of the location of the data.

**download.** (1) To transfer programs or data from a computer to a connected device, typically a personal

computer. (2) To transfer data from a computer to a connected device, such as a workstation or microcomputer.

**DRAM.** Dynamic random-access memory.

**drive, magnetic tape.** A mechanism for moving magnetic tape and controlling its movement.

**Drive Not Configured.** This message occurs during the first boot after a factory settings restore is executed. This is not a real issue since it takes the library a while to configure.

**DRV.** Drive.

**DSE.** Data security erase.

**DSP.** Digital signal processor.

## E

**EBCDIC.** Extended binary-coded decimal interchange code.

**EC.** Edge connector. Engineering change.

**ECC.** Error correction code.

**EEPROM.** Electrically erasable programmable read-only memory.

**EIA.** Electronics Industries Association.

**EIA unit.** A unit of measure, established by the Electronic Industries Association, equal to 44.45 millimeters (1.75 inches).

**eject.** To remove or force out from within.

**electronic mail.** Correspondence in the form of messages transmitted between user terminals over a computer network.

**e-mail.** See *electronic mail*.

**EPO.** Emergency power off.

**EPROM.** Erasable programmable read only memory.

**EQC .** Equipment check.

**equipment check.** An asynchronous indication of a malfunction.

**Error log.** A dataset or file in a product or system where error information is stored for later access.

**ESD.** Electrostatic discharge.

## F

**fault symptom code (FSC).** A hexadecimal code generated by the drive or the control unit microcode in response to a detected subsystem error.

**FC.** Feature code.

**FCC.** Federal communications commission.

**fiducial.** A target used for teaching a physical location to a robot.

**field replaceable unit (FRU).** An assembly that is replaced in its entirety when any one of its components fails.

**file.** A named set of records stored or processed as a unit. Also referred to as a dataset.

**file protection.** The processes and procedures established in an information system that are designed to inhibit unauthorized access to, contamination of, or deletion of a file.

**file transfer protocol (FTP).** In the Internet suite of protocols, an application layer protocol that uses TCP and Telnet services to transfer bulk-data files between machines or hosts.

**firmware.** Proprietary code that is usually delivered as microcode as part of an operating system. Firmware is more efficient than software loaded from an alterable medium and more adaptable to change than pure hardware circuitry. An example of firmware is the Basic Input/Output System (BIOS) in read-only memory (ROM) on a PC motherboard.

**FLASH EEPROM.** An electrically erasable programmable read-only memory (EEPROM) that can be updated.

**FMR.** Field microcode replacement.

**format.** The arrangement or layout of data on a data medium.

**formatter.** Part of a magnetic tape subsystem that performs data conversion, speed matching, encoding, first level error recovery, and interfaces to one or more tape drives.

**FP.** File protect.

**frayed.** Damaged as if by an abrasive substance.

**FRU.** Field replaceable unit.

**FSC.** Fault symptom code.

**FSI.** Fault symptom index.

**functional microcode.** Microcode that is resident in the machine during normal customer operation.

## G

**g.** Gram.

**GB.** gigabyte.

**GBIC.** Gigabit Interface Converter.

**Gbi.** gigabit

**gigabit (Gbit).** 1 000 000 000 bits.

**gigabyte (GB).** 1 000 000 000 bytes.

**Gigabit Interface Converter (GBIC).** Converts copper interface to optic interface.

**gnd.** Ground.

## H

**hertz (Hz).** Unit of frequency. One hertz equals one cycle per second.

**hex.** Hexadecimal.

**High Voltage Differential (HVD).** A logic signaling system that enables data communication between a supported host and the library. HVD signaling uses a paired plus and minus signal level to reduce the effects of noise on the SCSI bus. Any noise injected into the signal is present in both a plus and minus state, and is thereby canceled. Synonymous with *differential*.

**HVD.** SCSI Bus High Voltage Differential

**Hz.** Hertz (cycles per second).

## I

**ID.** Identifier.

**identifier (ID).** (1) In programming languages, a lexical unit that names a language object; for example, the names of variables, arrays, records, labels, or procedures. An identifier usually consists of a letter optionally followed by letters, digits, or other characters. (2) One or more characters used to identify or name data element and possibly to indicate certain properties of that data element. (3) A sequence of bits or characters that identifies a program, device, or system to another program, device, or system.

**IML.** Initial microprogram load.

**Incomp. Mag..** Incompatible Magazine: This message appears on the Operator Control Panel during library initializing. It occurs during factory restore or VPD. This is not a real issue since it takes the library a while to configure.

**initial microprogram load (IML).** The action of loading a microprogram from an external storage to writable control storage.

**initiator.** The component that executes a command. The initiator can be the host system or the tape control unit.

**INST.** Installation.

**interface.** A shared boundary. An interface might be a hardware component to link two devices or it might be a portion of storage or registers accessed by two or more computer programs.

**intervention required.** Manual action is needed.

**INTRO.** Introduction.

**I/O.** Input/output.

**IOP.** Input/output processor.

**IPL.** Initial program load.

**ISV.** Independent software vendor.

**ITST.** Idle-time self-test.

## K

**kilogram (kg).** One thousand grams (approximately 2.2 pounds).

**km.** kilometer. 1000 Meters, Approximately 5/8 mile.

## L

**LAN.** Local area network. A computer network within a limited area.

**LCD.** See *liquid crystal display*.

**LED.** Light-emitting diode.

**Linear Tape-Open (LTO).** A type of tape storage technology developed by the IBM Corporation, Hewlett-Packard, and Certance. LTO technology is an "open format" technology, which means that its users will have multiple sources of product and media. The "open" nature of LTO technology enables compatibility between different vendors' offerings by ensuring that vendors comply with verification standards. The LTO technology is implemented in two formats: the Accellis format focuses on fast access; the Ultrium format focuses on high capacity. The Ultrium format is the preferred format when capacity (rather than fast access) is the key storage consideration. An Ultrium cartridge has a compressed data capacity of up to 800 GB (2:1 compression) and a native data capacity of up to 400 GB.

**liquid crystal display (LCD).** A low-power display technology used in computers and other I/O devices.

**loadable.** Having the ability to be loaded.

**LTO cartridge memory (LTO-CM).** Within each LTO Ultrium data cartridge, an embedded electronics and interface module that can store and retrieve a cartridge's historical usage and other information.

**LVD.** SCSI Bus Low Voltage Differential

## M

**magnetic tape.** A tape with a magnetical surface layer on which data can be stored by magnetic recording.

**MAP.** Maintenance analysis procedure.

**mask.** A pattern of characters that controls the retention or elimination of portions of another pattern of characters. To use a pattern of characters to control the retention or elimination of portions of another pattern of characters.

**master file.** A file used as an authority in a given job and that is relatively permanent, even though its contents may change. Synonymous with main file.

**MB.** Mega Byte (usually expressed as data rate in MB/s or MB/second).

**media capacity.** The amount of data that can be contained on a storage medium, expressed in bytes of data.

**media-type identifier.** Pertaining to the bar code on the bar code label of the Ultrium Tape Cartridge, a 2-character code, L1, that represents information about the cartridge. L identifies the cartridge as one that can be read by devices which incorporate LTO technology; 1 indicates that it is the first generation of its type.

**mega.** One million of.

**meter.** In the Metric System, the basic unit of length; equal to approximately 39.37 inches.

**micro.** One millionth of.

**microcode.** (1) One or more micro instructions. (2) A code, representing the instructions of an instruction set, implemented in a part of storage that is not program-addressable. (3) To design, write, and test one or more micro instructions. (4) See also *microprogram*.

**microdiagnostic routine.** A program that runs under the control of a supervisor, usually to identify field replaceable units.

**microdiagnostic utility.** A program that is run by the customer engineer to test the machine.

**microinstruction.** A basic or elementary machine instruction.

**microprogram.** A group of microinstructions that when executed performs a preplanned function.

The term microprogram represents a dynamic arrangement or selection of one or more groups of microinstructions for execution to perform a particular function. The term microcode represents microinstructions used in a product as an alternative to hard-wired circuitry to implement certain functions of a processor or other system component.

**MIM.** Media information message.

**mm.** Millimeter.

**modifier.** That which changes the meaning.

**mount a device.** To assign an I/O device with a request to the operator.

**MP.** Microprocessor.

**ms.** Millisecond.

**MSG.** Message.

**multipath.** Pertaining to using more than one path.

## N

**N/A.** Not applicable.

**node.** In a network, a point at which one or more functional units connect channels or data circuits.

**NVS.** Nonvolatile storage. A storage device whose contents are not lost when power is cut off.

## O

**oersted.** The unit of magnetic field strength in the unrationalized centimeter-gram-second (cgs) electromagnetic system. The oersted is the magnetic field strength in the interior of an elongated, uniformly wound solenoid that is excited with a linear current density in its winding of one abampere per  $4\pi$  centimeters of axial length.

**offline.** Pertaining to the operation of a functional unit without the continual control of a computer. Contrast with *online*.

**online.** Pertaining to the operation of a functional unit that is under the continual control of a computer. Contrast with *offline*.

**OPER.** Operation.

**ov.** Over voltage.

**overrun.** Loss of data because a receiving device is unable to accept data at the rate it is transmitted.

**overtightening.** To tighten too much.

## P

**parameter.** A variable that is given a constant value for a specified application and that may denote the application.

**p bit.** Parity bit.

**PC.** Parity check.

**PCC.** Power control compartment.

**PDF.** Portable Document Format.

**PE.** Parity error. Product engineer.

**pick.** Pertaining to the library, to remove, by means of a robotic device, a tape cartridge from a storage slot or drive.

**picker.** A robotic mechanism located inside the library that moves cartridges between the cartridge storage slots and the drive.

**PM.** Preventive maintenance.

**POR.** Power-on reset.

**port.** A physical connection for communication between the drive/library and the host processor.

**Portable Document Format (PDF).** A standard specified by Adobe Systems, Incorporated, for the electronic distribution of documents. PDF files are compact, can be distributed globally (via e-mail, the Web, intranets, or CD-ROM), and can be viewed with the Acrobat Reader, which is software from Adobe Systems that can be downloaded at no cost from the Adobe Systems home page.

**PROM.** Programmable read only memory.

**PS.** Power supply.

**PWR.** Power.

## R

**rack.** A unit that houses the components of a storage subsystem, such as the library.

**rackmount kit.** A packaged collection of articles used to install the rack mounted version of the library.

**RAM.** Random access memory.

**Random access memory.** A storage device into which data is entered and from which data is retrieved in a nonsequential manner.

**RAS.** Reliability, availability, and serviceability.

**record.** A collection of related data or words, treated as a unit.

**recording density.** The number of bits in a single linear track measured per unit of length of the recording medium.

**recoverable error.** An error condition that allows continued execution of a program.

**ref.** Reference.

**reg.** Register.

**reinventory.** To inventory again.

**retention.** The process or function of tightening the tape onto the cartridge, if it is sensed that the tape has a loose wrap on the cartridge.

**RH.** Relative humidity.

**robot.** Picker.

**robotics.** Picker assembly.

**RPQ.** Request for price quotation.

**R/W.** Read/write.

## S

**s.** Seconds of time.

**scratch cartridge.** A data cartridge that contains no useful data, but can be written to with new data.

**SCSI.** Small computer system interface.

**SE.** Single-ended.

**segment.** A part.

**sel.** Select.

**Serial Attached SCSI (SAS).** A drive sled with a SAS interface can be linked directly to controllers. SAS is a performance improvement over traditional SCSI because SAS enables multiple devices (up to 128) of different sizes and types to be connected simultaneously with thinner and longer cables; its full-duplex signal transmission supports 3.0 GBs. In addition, SAS drives can be hot-plugged.

**serialize.** To change from parallel-by-byte to serial-by-bit.

**serializer.** A device that converts a space distribution of simultaneous states representing data into a corresponding time sequence of states.

**servo, servos.** An adjective for use in qualifying some part or aspect of a servomechanism.

**servomechanism.** A feedback control system in which at least one of the system signals represents mechanical motion.

**Simple Network Management Protocol.** SNMP, a standard TCP/IP protocol to send alerts about conditions (such as need for operator intervention) over a TCP/IP LAN network to an SNMP monitoring station.

**Slot Blocker.** A slot blocker is used to restrict/close off a data cell so a data cartridge cannot be placed there. This blocker can easily be removed.

**Small Computer Systems Interface (SCSI).** A standard used by computer manufacturers for attaching peripheral devices (such as tape drives, hard disks, CD-ROM players, printers, and scanners) to computers (servers). Pronounced "scuzzy". Variations of the SCSI interface provide for faster data transmission rates than standard serial and parallel ports (up to 160 megabytes per second). The variations include:

- Fast/Wide SCSI: Uses a 16-bit bus, and supports data rates of up to 20 MBps.
- SCSI-1: Uses an 8-bit bus, and supports data rates of 4 MBps.
- SCSI-2: Same as SCSI-1, but uses a 50-pin connector instead of a 25-pin connector, and supports multiple devices.
- Ultra SCSI: Uses an 8- or 16-bit bus, and supports data rates of 20 or 40 MBps.
- Ultra2 SCSI: Uses an 8- or 16-bit bus and supports data rates of 40 or 80 MBps.
- Ultra3 SCSI: Uses a 16-bit bus and supports data rates of 80 or 160 MBps.
- Ultra160 SCSI: Uses a 16-bit bus and supports data rates of 80 or 160 MBps.

**SNMP.** Simple Network Management Protocol, a standard TCP/IP protocol to send alerts about conditions (such as need for operator intervention) over a TCP/IP LAN network to an SNMP monitoring station.

**SNS.** Sense.

**special feature.** A feature that can be ordered to enhance the capability, storage capacity, or performance of a product, but is not essential for its basic work.

**SR.** Service representative, see also *CE*.

**SRAM.** Static random access memory.

**SS.** Status store.

**ST.** Store.

**standard feature.** The significant design elements of a product that are included as part of the fundamental product.

**START.** Start maintenance.

**subsystem.** A secondary or subordinate system, usually capable of operating independently of, or asynchronously with, a controlling system.

**SUPP.** Support.

**sync.** Synchronous, synchronize. Occurring with a regular or predictable time relationship.

## T

**tachometer, tach.** A device that emits pulses that are used to measure/check speed or distance.

**tape cartridge.** A container holding magnetic tape that can be processed without separating it from the container.

**tape void.** An area in the tape in which no signal can be detected.

**TCP/IP.** Transmission Control Protocol/Internet Protocol.

**TCU.** Tape control unit.

**TH.** Thermal.

**thread/load operation.** A procedure that places tape along the tape path.

**TM.** Tapemark.

## U

**UART.** Universal asynchronous receiver/transmitter.

**unload.** Prepare the tape cartridge for removal from the drive.

**utilities.** Utility programs.

**utility programs.** A computer program in general support of the processes of a computer; for instance, a diagnostic program.

**uv.** Under voltage.

## V

**VOLSER.** Volume serial number.

**volume.** A certain portion of data, together with its data carrier, that can be handled conveniently as a unit.

**VPD.** Vital product data. The information contained within the tape drive that requires nonvolatile storage used by functional areas of the drive, and information required for manufacturing, RAS, and engineering.

## W

**word.** A character string that is convenient for some purpose to consider as an entity.

**World Wide Node Name (WWNN).** In a fibre channel connected library, the Drive ID as listed in the Web User Interface.

**Write.** Write command.

**WT.** world trade.

## X

**XR.** External register.

**XRA.** External register address register.



---

# Index

## A

- Access PIN, Operator Control Panel 5-26
- accessibility
  - keyboard H-1
  - repeat rate of up and down buttons H-1
  - shortcut keys H-1
- accessor 1-6
- accessory package 4-2
- active slots 5-20, 5-44
- Active Slots 4-19
- air quality 4-1
- air vents, front panel 1-1
- AME 5-47
- Application Managed Encryption (AME) 4-22
- ASC C-1
- ASCQ C-1
- auto clean 5-20, 5-44
- Auto Clean 4-19

## B

- Bar Code Labels 6-4
  - guidelines for using 6-5
- bar code reader 1-6
- bootcode firmware, current level 5-34
- BOP 5-38
- Border Gateway Protocol (BGP) 1-7

## C

- cable, host interface 4-11
- Cartridge 1-11, 6-1
  - capacity scaling 6-1
  - cleaning 6-4
  - compatibility 6-2
  - data 6-1
  - proper handling 6-7
  - specifications 6-9
  - Write-Protect Switch 6-6
- cartridge magazines 1-1, 4-32
- Cartridge, environment 6-8
- cartridge, suspect 2-2
- cartridges
  - inserting in library 4-36
  - populating library 4-36
- Cartridges, insert and remove 5-64
- channel calibration 1-10
- choosing a location 4-1
- clean drive 5-57
- cleaning slot 5-65
- clearance 4-1
- Configure menu
  - network settings 4-15
- configuring library using Web User Interface 4-15
- configuring the library 4-14
- control keys 5-7

- control path drive 5-35, 5-49
- control path failover 3-2, 5-46
- control paths 5-23
  - multiple 3-2
  - using multiple for control path failover 3-2

## D

- daisy-chaining 3-9
- Data Cartridge 5-64
- data transfer rate 1-8
- DCS 5-65
- dedicated cleaning slot A-2
- default settings 5-27
- description 1-1
- desktop installation 4-1
- Device drivers supported 1-14
- DHCP 4-15, 4-24, 5-24, 5-50
- Diagnostics 5-60
- display contrast 5-32
- dll 7-12
- Drive
  - channel calibration 1-10
  - power management 1-11
  - speed matching 1-10
- drive configuration 5-49
- Drive Density 5-38
- Drive Diagnostics 5-31, 5-60
- drive dump, saving to host 5-60
- drive firmware, current version 5-35
- drive interface 5-23
- Drive Log 5-59
- drive serial number 5-35
- drive sled
  - description 1-9
- drive status 5-38
- drive, clean 5-57

## E

- EC 5-14
- ED 5-14
- EKM 4-22
- EKM Server Setting 4-22
- element addresses 3-3, A-2, A-3
- element addressing A-1
- element types A-1
- Encryption 1-6, 4-22
- environment 1-13
  - operating 1-13
  - particulates 1-13
- environmental specifications 1-11
- Error Codes 8-1
- Error LEDs 7-7
- Error log 8-1
- Ethernet Port 1-3
- Export Media 4-36, 5-16, 5-42, 5-64

## F

- factory default settings 5-27
- fan vents 1-3
- feature activation key 5-46
- features
  - optional
    - drives 1-9
- Fibre Channel 3-7
- Fibre Channel interface
  - cables and speeds 3-10
  - sharing on a SAN 3-10
  - zoning 3-10
- Fibre Channel ports 3-9
- Firmware
  - updating
    - using ITDT Tool 9-4
- firmware, upgrade 5-62
- foot pads, installing 4-3
- front panel components 1-1

## G

- Gateway address 4-15
- Gateway Address 4-24, 5-24, 5-50
- glossary 1-1

## H

- Host Attachment 7-12
- host bus adapter 3-6
- host connection, verifying 4-32
- host interface cable 4-11
- host interface connectors 1-3
- host interfaces 3-7
- host preparation 4-31
- humidity 4-1

## I

- I/O Station 1-1, 4-32, 5-64
- I/O Station, configuring 5-65
- I/O Station, open and close 5-65
- identifying a suspect cartridge 1-1, 2-2
- Import Media 4-36, 5-16, 5-42, 5-64
- installation 4-1
- Interface 7-12
- interfaces 3-7
- interfaces, supported 1-9
- Internet Protocol version 4 1-7
- Internet Protocol version 6 1-7
- Inventory 5-14, 5-43
- IP address 4-15, 5-34
- IP Address 4-24, 5-24, 5-50
- IP Stack 5-24
- IPv4 1-7
- IPv6 1-7
- ITDT Tool 9-4

## K

Key Path 5-38  
Key Path Diagnostics 5-61  
keyboard H-1

## L

Labels  
    bar code 6-4  
    guidelines for using 6-5  
LED, amber 7-12  
LEDs 2-2, 7-7  
LEDs, front panel 1-1  
library configuration form G-1  
library firmware, current level 5-34  
library logs 5-58  
library mode 4-19, 5-20, 5-34, 5-44  
library name 5-44  
library network configuration 4-24, 5-50  
library recovery 7-6  
library SNMP configuration 4-29, 5-56  
library status 5-37  
Library Verify 5-30  
library weight 1-11  
license activation key 4-21, 4-22, 5-29  
Link-local IPv6 address 5-10  
Linux D-1, D-2  
LME 5-47  
locating the library 4-1  
logical libraries 4-20, 5-18, 5-45  
    determining number 3-1  
    basic guidelines 3-1  
    using multiple for sharing 3-2  
logical libraries, assigning 4-20  
logs 5-58  
low voltage differential (LVD) SCSI  
    interface 1-9  
low-power mode 1-11  
LUN 3-6, D-1, D-2  
LUN scanning 3-6  
LVD SCSI interface 1-9

## M

MAC Address 1-7  
magazines 1-1, 4-32  
Maximum Transmission Unit (MTU) 1-7  
media 1-11  
Media 6-1  
media capacity 1-1  
menu shortcuts 5-1  
menu tree  
    Operator Control Panel 5-9  
Menus  
    Configure  
        network settings 4-15  
MIB 1-7, B-1  
Monitor menu  
    Drive 5-12  
    Library 5-10  
Move Media 4-36, 5-16, 5-42  
Multiple control paths 3-2

## N

Navigation 5-7  
Netmask 4-15  
Network Address Translation (NAT) 1-7  
network configuration 5-24  
Network Mask 4-24, 5-24, 5-50  
network settings 5-24

## O

OCP 4-31  
ON/OFF power button 2-4  
operation specifications 1-11  
Operator Control Panel  
    Access PIN 5-26  
    Configure: Save/Restore 5-27  
    control keys on front panel 1-1  
    display 1-1  
    menu tree 5-9  
    Monitor menu  
        Drive 5-12  
        Library 5-10  
    power ON display 2-2  
Operator Control Panel menus  
    Configure: Drive 5-23  
    Configure: Library 5-20

## P

packaging materials 4-2  
partitioning 3-3, 4-20, A-3  
partitioning your 4U library 5-45  
path failover 4-21, 5-29  
physical specifications 1-11  
power button 1-1, 2-4  
power connector 1-3  
power management 1-11  
power ON display 2-2  
power source 4-1  
power specifications 1-11  
Power Supply Problem 7-7  
product ID 5-34  
PTF 7-12

## Q

Quiesce 5-61

## R

rack installation 4-1, 4-6  
rack mounting the library 4-6  
rack requirements 4-1  
RAID controllers 3-6  
Read/Write capability 6-2  
rear panel of library 1-3  
Remove/replace procedures 10-1  
reserve slot, active slot 5-65  
Reserved Slots 4-19  
RFC (Request for Comments) 1-7  
Router assigned IPv6 address 5-10

## S

Safety inspection procedure xiv  
SAS interface 3-9  
screens displayed at power ON 2-2  
SCSI interface 3-7  
    bus termination 3-9  
    description 1-9  
    multiple buses 3-8  
    physical characteristics 3-7  
SCSI LVD 3-7, 3-9  
SCSI Trade Association Web site 3-9  
Sense data  
    using C-1  
sense data, library C-1  
sequential mode, starting 5-20  
sequential mode, stopping 5-20  
serial number 5-34  
serial number, drive 5-35  
Serial Port 1-3  
server attachment  
    SCSI interface 3-7  
Sharing the library 3-1  
shipment verification 4-2  
shipping container 4-2  
shipping label, removing and  
    storing 4-4  
shipping lock and label storage  
    location 1-3  
shipping lock, removing and storing 4-4  
shortcut keys H-1  
Simple Network Management  
    Protocol 1-7  
sled, description of tape drive 1-9  
slot physical locations A-2  
SME 5-47  
SNMP 1-7, 4-29, 5-50, 5-56, B-1, F-1  
specifications 1-11  
    environmental 1-11  
    operation 1-11  
    physical 1-11  
    power 1-11  
Specifications  
    cartridges 6-9  
speed matching 1-10  
SSL 4-24, 5-50  
storage capacity 1-8

## T

tape cartridge 1-11  
tape drive sled 1-3  
Tape drives  
    channel calibration 1-10  
    power management 1-11  
    quantity in library 1-9  
    speed matching 1-10  
TapeAlert Flags  
    for drives B-2  
TapeAlert Flags, library B-1  
Telnet Service Port 5-33  
Traps F-1  
troubleshooting 7-1

## U

- Ultra160 1-8
- Ultra320 1-8
- Ultrium Tape Drives 1-9
- unpacking the library 4-2
- Updating firmware
  - using ITDT Tool 9-4
- upgrade firmware 5-62
- USB port 1-3

## V

- verifying the shipment 4-2
- View Drive Logs 5-59

## W

- Web User Interface
  - Configure Library: Email Notification 5-55
  - Configure Library: Save/Restore 5-56
  - configuring library 4-15
  - drive information 4-24
  - event notification 4-29
  - general library information 4-19
  - logging on 4-17
  - logs and traces 4-28
  - user access information 4-26
- Web User Interface menus
  - Configure Library: User Access 5-52
- Web User InterfaceConfigure Library
  - date and time 4-28
- worldwide node name 5-34
- WORM (Write Once, Read Many) 6-3
- Write Once, Read Many (see WORM) 6-3
- write-protect switch
  - Write Protect Switch Setting B-3
- Write-Protect Switch
  - setting 6-6
- WWNN 5-34



