

# PowerEdge R810



## Technical Guide



The PowerEdge R810 is designed with a purpose—to make your life easier. PowerEdge gives you the confidence to do your job.

This document is for informational purposes only. Dell reserves the right to make changes without further notice to any products herein. The content provided is as is and without express or implied warranties of any kind.

Dell, PowerEdge, ReadyRails, and Dell OpenManage are trademarks of Dell, Inc. Citrix is a registered trademark and XenServer is a trademark of Citrix Systems, Inc. and/or one or more of its subsidiaries, and may be registered in the United States Patent and Trademark Office and in other countries. Intel, Xeon, and SpeedStep are registered trademarks and MMX and Core are trademarks of Intel Corporation in the U.S. and other countries. Broadcom is a registered trademark and NetXtreme is a trademark of Broadcom Corporation and/or its affiliates in the United States, certain other countries and/or the EU. Emulex is a registered trademark of Emulex Corporation. ENERGY STAR is a registered trademark of the U.S. Environmental Protection Agency. Matrox is a registered trademark of Matrox Electronic Systems Ltd. Microsoft, Windows, Windows Server, SQL Server, and BitLocker, and Hyper-V are either registered trademarks or trademarks of Microsoft Corporation in the United States and/or other countries. Novell and SUSE are registered trademarks of Novell, Inc., in the United States and other countries. Linux is a registered trademark of Linus Torvalds. VMware and ESX are registered trademarks and vSphere and ESXi are trademarks of VMware, Inc. in the United States and/or other jurisdictions. Other trademarks and trade names may be used in this document to refer to either the entities claiming the marks and names or their products. Dell disclaims proprietary interest in the marks and names of others.

©Copyright 2011 Dell Inc. All rights reserved. Reproduction or translation of any part of this work beyond that permitted by U.S. copyright laws without the written permission of Dell Inc. is unlawful and strictly forbidden.

# Table of Contents

1	Product Comparison .....	7
1.1	Overview .....	7
1.2	Customer-Inspired Design .....	7
1.3	Energy Efficient .....	7
1.4	Easy to Manage .....	7
1.5	Comparison .....	8
2	Key Technologies.....	10
2.1	Overview .....	10
2.2	Detailed Information .....	10
2.2.1	Intel 7500 Chipset.....	10
2.2.2	Intel Processors.....	10
2.2.3	Dell FlexMem Bridge .....	11
2.2.4	Internal Dual SD Module .....	11
3	System Information .....	12
4	Mechanical .....	14
4.1	Chassis Description.....	14
4.2	Dimensions and Weight.....	15
4.3	Front-Panel View and Features .....	15
4.4	Back-Panel View and Features .....	16
4.5	Power Supply Indicators.....	16
4.6	NIC Indicators.....	16
4.7	Rails and Cable Management .....	16
4.8	Rack View .....	17
4.9	Fans .....	18
4.10	LCD Control Panel.....	18
4.11	Security .....	19
4.11.1	Cover Latch .....	19
4.11.2	Bezel .....	19
4.11.3	Hard Drive .....	19
4.11.4	Trusted Platform Module (TPM) .....	19
4.11.5	Power Off Security .....	19
4.11.6	Intrusion Alert .....	19
4.11.7	Secure Mode .....	19
4.12	USB Key .....	19
4.13	Battery.....	20
4.14	Field Replaceable Units (FRU).....	20
4.15	User Accessible Jumpers, Sockets, and Connectors.....	20
5	Power, Thermal, Acoustic .....	21
5.1	Power Subsystem.....	21
5.1.1	Power Distribution Board .....	21
5.2	Power Efficiency .....	21
5.3	Power Supplies .....	21
5.4	Heat Dissipation .....	22
5.5	Environmental Specifications.....	22
5.6	ENERGY STAR Compliance .....	23
5.7	Thermal.....	23
5.8	Acoustics .....	24
5.9	PCI Express Riser Connectors .....	26
5.10	Super I/O Controller .....	26

6	Processors .....	27
6.1	Overview .....	27
6.2	Features .....	27
6.3	Supported Processors .....	28
6.4	Processor Configurations .....	29
6.5	FlexMem Bridge .....	29
7	Memory .....	31
7.1	Overview .....	31
7.2	DIMMs Supported .....	31
7.3	Memory System Key Features .....	31
7.4	Memory Speed Limitations .....	32
7.5	DIMM Slots .....	32
7.6	Memory Access .....	33
7.7	Memory RAS Support .....	33
7.7.1	Sparing .....	34
7.7.2	Mirroring .....	34
7.8	Memory RAID .....	35
7.9	Supported Configurations .....	35
8	Chipset .....	36
8.1	Overview .....	36
8.2	Intel 7500 Chipset I/O Hub (IOH) .....	36
8.3	IOH PCI Express (PCIe) .....	36
8.4	Enterprise Southbridge Interface (ESI) .....	36
8.5	Intel I/O Controller Hub 10 (ICH10) .....	36
9	BIOS .....	37
9.1	Overview .....	37
9.2	Supported ACPI States .....	37
10	Embedded NICs/LAN on Motherboard (LOM) .....	38
11	PCI Slots .....	39
11.1	Overview .....	39
11.2	Quantities and Priorities .....	39
11.2.1	I/O Planar PCI Express Slots .....	39
11.2.2	PCI Express Risers .....	39
11.2.3	Additional Riser Restrictions .....	39
11.3	Boot Order .....	40
11.4	NICs and External Controller Cards .....	40
12	Storage .....	41
12.1	Overview .....	41
12.2	Persistent Storage .....	41
12.2.1	iDRAC6 Express .....	41
12.2.2	Unmanaged Persistent Storage .....	42
12.2.3	Flash BIOS memory .....	43
12.3	Backplane .....	43
12.4	Supported Drives .....	43
12.5	RAID Configurations .....	44
12.6	Storage Controllers .....	45
12.6.1	PERC H200 .....	45
12.6.2	PERC H700 .....	45
12.6.3	PERC H800 .....	45
12.7	LED Indicators .....	46
12.8	Optical Drives .....	46
12.9	External Storage Support and Tape Drives .....	46

## Dell

13	Video.....	47
14	Rack Information.....	48
14.1	Overview .....	48
14.2	Rails .....	48
14.3	Cable Management Arm .....	49
14.4	Rack View .....	49
15	Operating Systems .....	51
16	Systems Management.....	52
16.1	Overview .....	52
16.2	Server Management.....	52
16.3	Embedded Server Management .....	52
16.4	Dell Lifecycle Controller and Unified Server Configurator .....	53
16.5	Integrated Dell Remote Access Controller.....	53
16.6	iDRAC6 Express .....	54
16.7	iDRAC6 Enterprise.....	54
16.8	iDRAC6 Enterprise with Virtual Flash (vFlash) Media .....	54
17	Peripherals.....	57
17.1	USB Peripherals.....	57
17.2	External Storage.....	57
Appendix A.	Statement of Volatility .....	58
Appendix B.	Certifications .....	62
B 1.	Regulatory Certifications .....	62
B 2.	Product Safety Certifications.....	62
B 3.	Electromagnetic Compatibility.....	63
B 4.	Ergonomics, Acoustics and Hygienics .....	63
Appendix C.	Industry Standards .....	64

## Tables

Table 1.	Product Comparison .....	8
Table 2.	Product Features Summary .....	12
Table 3.	Power Supply Status Indicator.....	22
Table 4.	Environmental Specifications.....	23
Table 5.	Acoustical Performance .....	25
Table 6.	Supported Intel Xeon E7-8800 Product Family .....	28
Table 7.	Supported Intel Xeon E7-4800 Product Family .....	28
Table 8.	Supported Intel Xeon E7-2800 Product Family .....	28
Table 9.	Supported Intel Xeon Processor 6500 and 7500 Series.....	28
Table 10.	PowerEdge R810 Sparing and Mirroring .....	33
Table 11.	Mixing of Drive Types .....	41
Table 12.	Supported Drives for R810 .....	43
Table 13.	Single Drive Type RAID Configurations .....	44
Table 14.	Mixed SSD and SAS RAID Configurations.....	45
Table 15.	Storage Card Support Matrix.....	46
Table 16.	Supported Video Modes .....	47
Table 17.	Supported Racks.....	49
Table 18.	Rail Adjustability Ranges and Depth .....	49
Table 19.	Unified Server Configurator Features and Description.....	53
Table 20.	Features List for Base Management Functionality, iDRAC, and vFlash .....	55
Table 21.	System Volatility .....	58
Table 22.	Product Safety Certifications.....	62
Table 23.	Electromagnetic Compatibility Certifications.....	63

Dell

Table 24.	Ergonomics, Acoustics and Hygienics.....	63
Table 25.	Industry Standards .....	64

### Figures

Figure 1.	Front View (with Bezel) .....	14
Figure 2.	Chassis Dimensions .....	15
Figure 3.	Front-Panel View (without Bezel).....	15
Figure 4.	Back-Panel View .....	16
Figure 5.	Server Extended for Servicing .....	17
Figure 6.	Front and Back Rack-mount and Rail Views Showing CMA and Support Tray .....	18
Figure 7.	Power Supply.....	22
Figure 8.	Diagram of FlexMem Bridge Routing.....	30
Figure 9.	DIMM Naming and Numbering.....	33
Figure 10.	2P Mirroring .....	34
Figure 11.	4P Mirroring .....	35
Figure 12.	Internal Dual SD Module Shown with a Single Card.....	43
Figure 13.	ReadyRails Sliding Rails with Optional CMA.....	48
Figure 14.	R810 Mounted in the B2 Sliding Rails .....	50
Figure 15.	CMA Mounted on the Side Opposite the Power Supplies (Recommended) .....	50

# 1 Product Comparison

## 1.1 Overview

The Dell™ PowerEdge™ R810 provides performance and rack density in a scalable 2U, two- or four-socket server, allowing workload consolidation or high virtualization machine density.

FlexMem Bridge Technology delivers compute resources; more memory per processor solves growing memory demand needs for database and virtualization applications.

Built with highly reliable Intel® Xeon® E7-4800 and E7-8800 product family or Intel Xeon processor 6500 and 7500 series, high-capacity DDR3 memory, and enterprise-class manageability, the PowerEdge R810 provides outstanding price for performance with excellent memory capacity per processor.

## 1.2 Customer-Inspired Design

Inspired by our customers, the PowerEdge R810 is built from Intel Advanced RAS (Reliability, Availability, Serviceability) features and dual internal SD modules to embedded diagnostics and industrial-quality materials. Dual internal SD modules provide failover capability for the embedded hypervisor; this feature was designed based on customer reliability feedback. Dell listened and delivered.

FlexMem Bridge technology scales memory capacity allowing two processors from the Intel Xeon E7-4800 and E7-8800 product family or the Intel Xeon processor 6500 and 7500 series access to all 32 DIMM slots, delivering more memory resources for outstanding application performance. This Dell innovation allows customers to scale memory and take full advantage of the resources that matter most.

Every fully configured Dell server is tested (and re-tested) before it leaves the factory. Our one-touch process is designed to ensure one person is responsible for the entire server build, resulting in greater quality control.

## 1.3 Energy Efficient

The PowerEdge R810 follows the eleventh-generation PowerEdge behavioral specifications with the same system design commonality and usability true to the entire portfolio. All eleventh-generation PowerEdge servers are designed to make the user experience easier while saving time and money.

Energy-efficient system design built with Energy Smart technologies includes power management features enabling power capping, power inventory, and power budgeting within your specific environment. Logical component layout of the internal components aids with airflow direction, helping to keep the server cool.

## 1.4 Easy to Manage

Dell system management solutions focus on simplicity, efficiency, cost containment and reduction, and an adherence to open standards. Our solutions are complemented by, connected to, and integrated with 3rd-party offerings, thereby delivering comprehensive solutions across the complete solutions stack.

The Lifecycle Controller is a chip that is integrated on the server. It helps to simplify administrator tasks by performing a complete set of provisioning functions such as system deployment, system updates, hardware configuration, and diagnostics in a pre-OS environment—all from a single, intuitive interface called the Unified Server Configurator (USC).

## 1.5 Comparison

The R810 does not have a direct predecessor. It is a new class of server for Dell—a highly scalable 2U 2S rack server intended to fill the gap between the general purpose 2U 2S and the 4U 4S server space. The R810 is scalable to 4S if required, with 32 DIMM slots available in both 2S and 4S configurations.

Comparison to the R710 and R910 servers is shown in Table 1.

**Table 1. Product Comparison**

Feature	PowerEdge R710	PowerEdge R810	PowerEdge R910
Chipset	Intel® 5520	Intel® 7500	Intel® 7500
Processor	Intel® Xeon® 5500 or 5600 Quad-core or six-core	Intel® Xeon® E7-2800, E7-4800, and E7-8800 product family Intel Xeon processor 6500 and 7500 series	Intel® Xeon® E7-4800 and E7-8800 product family Intel Xeon processor 7500 series Two or four 4-core, 6-core, 8-core, or 10-core 95W, 105W, and 130W TDP options
Socket	2S	2S or 4S	4S
Memory	Up to 18 x DDR3	Up to 32 x DDR3	Up to 64 x DDR3
DIMM Capacity	1, 2, 4, 8, and 16GB	1, 2, 4, 8, and 16GB	1, 2, 4, 8, 16, and 32GB
Slots	Four PCIe Gen2 slots + 1 storage slot: Two x8 slots Two x4 slots One x4 storage slot	Six PCIe Gen2 slots + 1 storage slot: Five x8 slots One x4 slot One storage x4 slot	Standard: Seven PCIe Gen2 slots (2 x4, 4 x8, 1 x16) Optional: Ten PCIe Gen2 (6 x4, 4 x8) (slot 5 is Gen1)
Hard Drive Bays	8 x 2.5" or 6 x 3.5" Hot-plug	6 x 2.5" Hot-plug	16 x 2.5" Hot-plug
Power Supply	Hot-plug, redundant	Hot-plug, redundant	Hot-plug, redundant
NIC/LOM	Broadcom® BCM5709C 4 x iSCSI TOE Optional: various NICs available	Broadcom® BCM5709C 4 x iSCSI TOE Optional: various NICs available	4-port (4 x 1GbE) Embedded NIC Broadcom 5709c, or 4-port (2 x 10Gb SFP+ and 2 x 1GbE) Embedded NIC Broadcom 57711 + Broadcom 5709c Optional: various NICs available



## Dell

Feature	PowerEdge R710	PowerEdge R810	PowerEdge R910
<b>Server Management</b>	iDRAC6 Express, BMC, IPMI 2.0, Dell OpenManage™ Optional: iDRAC6 Enterprise, vFlash media	iDRAC6 Express, BMC, IPMI 2.0, Dell OpenManage™ Optional: iDRAC6 Enterprise, vFlash media	iDRAC6 Express, BMC, IPMI 2.0, Dell OpenManage™ Optional: iDRAC6 Enterprise, vFlash media

## 2 Key Technologies

### 2.1 Overview

The Dell™ PowerEdge™ R810 implements a number of new technologies:

- Intel® Xeon® E7-2800, E7-4800, and E7-8800 product family
- Fusion-io® cards

The R810 also implements a number of key technologies:

- Intel 7500 chipset
- Dell patent-pending FlexMem Bridge
- Internal Dual SD module

### 2.2 Detailed Information

#### 2.2.1 Intel 7500 Chipset

The 7500 chipset is designed to support Intel Xeon processor E7 product family, Intel Xeon processor 6500 and 7500 series, Intel QuickPath Interconnect (QPI), DDR3 memory technology, and PCI Express Generation 2 (PCIe Gen2). The 7500 chipset consists of the IOH QuickPath Interconnect (QPI), Intel E7510 Scalable Memory Buffer, and the ICH10 South Bridge.

#### 2.2.2 Intel Processors

Key features of the Intel Xeon processor E7 product family include:

- Up to ten cores per processor
- Up to 30 MB shared L3 cache
- 32 nm process technology
- Intel Trusted Execution Technology (TXT) and AESNI (AES New Instructions)
- RAS DDDC (Double Device Data Correct)
- Intel HyperThreading (two threads/core)

Key features of the Intel Xeon processor 6500 and 7500 series include:

- Up to eight cores per processor
- Four full-width, bidirectional point-to-point Intel QuickPath Interconnect (QPI) links at 6.4 GT/s
- Four Intel® Scalable Memory Interconnects (SMI) at 6.4 GT/s
- Socket: LS, LGA 1567 package
- No termination required for non-populated processors (must populate processor socket 1 first)
- 64-byte cache line size
- RISC/CISC hybrid architecture
- Compatible with existing x86 code base
- Optimized for 32-bit code
- MMX support
- Execute Disable Bit
- Intel Wide Dynamic Execution (Executes up to four instructions per clock cycle)
- Simultaneous Multi-Threading (SMT) capability (2 threads/core)
- Support for CPU Turbo Mode on certain models (Increases processor frequency if operating below thermal, power, and current limits)
- Streaming SIMD (Single Instruction, Multiple Data) Extension 4
- Intel 64 Technology

## Dell

- Intel VT-x and VT-d Technology for virtualization support
- Enhanced Intel SpeedStep® Technology
- Demand-based switching for active processor power management as well as support for ACPI P-States, C-States, and T-States

### 2.2.3 Dell FlexMem Bridge

The PowerEdge R810 also features a Dell technology that allows flexibility in processor and memory scalability—the FlexMem Bridge. The FlexMem Bridge allows the full amount of addressable DIMMs on four-socket systems with the Intel Xeon processor E7 product family and Intel Xeon processor 7500 and 6500 series to be accessed, even when only two of the processors are in place, in a completely passive solution (no active components).

### 2.2.4 Internal Dual SD Module

The PowerEdge R810 also offers a second internal USB port dedicated for embedded Hypervisor for virtualization operating systems like Citrix® and VMware® through a dual SD-to-USB daughter card called an Internal Dual SD Module (ISDM). The ISDM port is located behind the control panel. The SD flash cards contain a bootable operating system image for virtualized platforms. ISDM consists of up to two SD cards that are mirrored when set in the redundant mode for the higher availability.

### 3 System Information

Table 2 lists a summary of features for the Dell™ PowerEdge™ R810. For the latest information on supported features, visit [Dell.com](http://Dell.com).

**Table 2. Product Features Summary**

Feature	Details
Form Factor	2U rack
Processors	Up to ten-core Intel® Xeon® E7-2800, E7-4800, and E7-8800 product family or Up to eight-core Intel Xeon processor 7500 and 6500 series
Processor Sockets	Two or four
Front Side Bus or HyperTransport	Intel QuickPath Interconnect (QPI)
Cache	Up to 30MB
Chipset	Intel 7500 Chipset
Memory <sup>1</sup>	Up to 512GB (32 DIMM slots) 1GB/2GB/4GB/8GB/16GB DDR3 1066MHz
I/O Slots	<b>Six PCIe Gen2 slots:</b> <ul style="list-style-type: none"> <li>• Five x8 slot</li> <li>• One x4 slot</li> <li>• One storage x4 slot</li> </ul>
RAID Controller	<b>Internal Controllers:</b> <ul style="list-style-type: none"> <li>• PERC H200 (6Gb/s)</li> <li>• PERC H700 (6Gb/s) with 512MB or 1GB non-volatile battery-backed cache</li> </ul> <b>External Controllers:</b> <ul style="list-style-type: none"> <li>• PERC H800 (6Gb/s) with 512MB or 1GB non-volatile battery-backed cache</li> <li>• PERC 6/E with 256MB or 512MB of battery-backed cache</li> </ul> <b>External HBAs (non-RAID):</b> <ul style="list-style-type: none"> <li>• 6Gbps SAS HBA</li> <li>• SAS 5/E HBA</li> <li>• LSI2032 PCIe SCSI HBA</li> </ul>
Drive Bays	Up to six hot-plug 2.5" drives
Maximum Internal Storage <sup>1</sup>	Up to 6TB
Hard Drives	2.5" SATA SSD, SAS (10K, 15K), nearline SAS (7.2K), SATA (7.2K)
Network Interface Cards	Broadcom® 57710 Single Port 10GbE NIC, Copper CAT6 PCIe-8 Intel DA 10GbE NIC, Dual Port, Optical, PCIe-8 Intel 10GbE Single Port 10GbE NIC, Copper, PCIe-8 Broadcom NetXtreme® II 5709 Gigabit NIC with TOE and iSOE, Quad Port, Copper, PCIe-8

	<p>Broadcom 5709 Dual Port 1GbE NIC with TOE PCIe-4, Low Profile</p> <p>Broadcom 5709 Dual Port 1GbE NIC with TOE iSCSI, PCIe-4, Low Profile</p> <p>Broadcom 5709 Dual Port 1GbE NIC with TOE iSCSI, PCIe-4</p> <p>Broadcom NetXtreme II 5709 Gigabit NIC with TOE and iSOE, Quad Port, Copper, PCIe-4, Low Profile</p> <p>Broadcom 5709 Dual Port 1GbE NIC with TOE PCIe-4</p> <p>Broadcom NetXtreme II 57711 10GbE NIC with TOE and iSOE, Dual Port, SFP+, PCIe-8</p> <p>Intel Gigabit ET NIC, Dual Port, Copper, PCIe-4, Low Profile</p> <p>Intel Gigabit ET Dual Port NIC, PCIe-4</p> <p>Intel Gigabit ET NIC, Quad Port, Copper, PCIe-4, Low Profile</p> <p>Broadcom 5709 Dual Port 1GbE NIC w/TOE PCIe-4, Low Profile</p> <p>Intel Gigabit ET Quad Port NIC, PCIe-4</p> <p><b>Embedded Network Controllers:</b></p> <p>Emulex<sup>®</sup> CNA iSCSI HBA stand up adapter OCE10102-IX-D</p> <p>Emulex CNA iSCSI HBA stand up adapter OCE10102-FX-D</p>
<b>Power Supply</b>	Optional two redundant 1100W hot-plug power supplies
<b>Availability</b>	Hot-plug hard drives and redundant power, ECC memory, dual internal SD module
<b>Video</b>	Matrox <sup>®</sup> G200eW with 8MB memory
<b>Remote Management</b>	<p>iDRAC6 Express</p> <p>iDRAC6 Enterprise (optional)</p> <p>vFlash media (optional)</p>
<b>Systems Management</b>	<p>BMC, IPMI 2.0 compliant</p> <p>Dell<sup>™</sup> OpenManage<sup>™</sup></p> <p>Unified Server Configurator</p> <p>Lifecycle Controller enabled with iDRAC6 Express, iDRAC6 Enterprise, and vFlash media</p>
<b>Rack Support</b>	ReadyRails <sup>™</sup> sliding rails with optional cable management arm for 4-post racks (optional adapter brackets required for threaded hole racks)
<b>Operating Systems</b>	<p>Microsoft Windows<sup>®</sup> Server 2008 SP2, x86/x64 (x64 includes Hyper-V<sup>™</sup>)</p> <p>Microsoft Windows Server 2008 R2 SP1, x64 (includes Hyper-V v2)</p> <p>Microsoft<sup>®</sup> Windows HPC Server 2008</p> <p>Novell<sup>®</sup> SUSE<sup>®</sup> Linux<sup>®</sup> Enterprise Server</p> <p>Red Hat<sup>®</sup> Enterprise Linux</p> <p><b>Virtualization Options:</b></p> <p>Citrix<sup>®</sup> XenServer<sup>™</sup></p> <p>VMware<sup>®</sup> vSphere<sup>™</sup> 4.1 (including VMware ESX<sup>®</sup> 4.1 or VMware ESXi<sup>™</sup> 4.1)</p> <p>For more information on the specific versions and additions, visit <a href="http://Dell.com/OSsupport">Dell.com/OSsupport</a>.</p>
<p><sup>1</sup> GB means 1 billion bytes and TB equals 1 trillion bytes; actual capacity varies with preloaded material and operating environment and will be less.</p>	

## 4 Mechanical

### 4.1 Chassis Description

The Dell™ PowerEdge™ R810 chassis is a 2U rack-mount design constructed primarily of steel. It includes a handle at the rear of the chassis. The optional front bezel is also safety rated as a handle (when properly installed) so that the server can be easily lifted using the bezel and back handle.

The R810 chassis includes the following features:

- Slide-out drive bay section to allow servicing of DIMMs below drives
- Updated industrial design including an LCD screen, bezel, and hard drive carriers
- Toolless rack latches
- Pull-out tray for Express Service Tag and customer labels
- Support for persistent storage (internal USB and SD card slots and external SD card slot)
- Updated power supply removal process (see the Power Supplies chapter of the *PowerEdge R810 Hardware Owner's Manual* on [Support.Dell.com/Manuals](http://Support.Dell.com/Manuals)).



Figure 1. Front View (with Bezel)

## 4.2 Dimensions and Weight

Figure 2 details the dimensions of the R810 chassis.

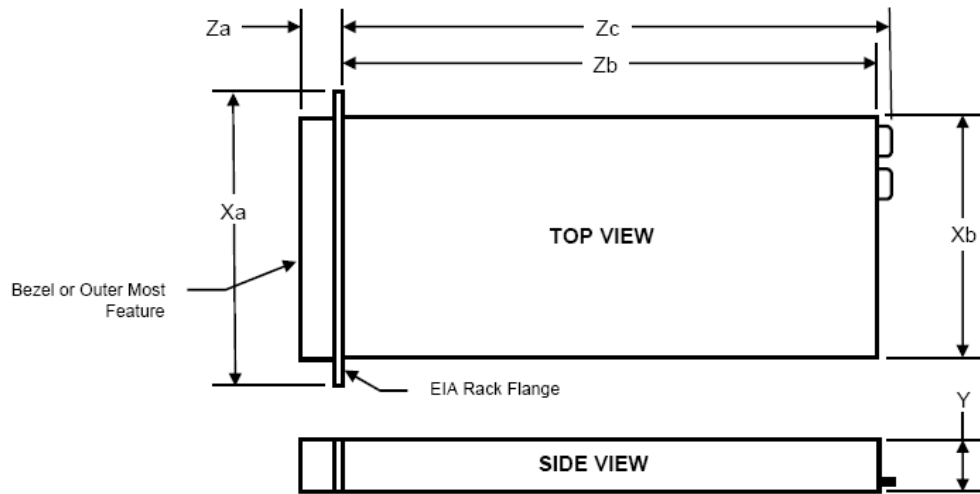

Xa	Xb	Y	Za (with bezel)	Za (without bezel)	Zb	Zc
482.4mm	443.1mm	86.4mm	35.0mm	23.5mm	717.5mm	720.6mm

Figure 2. Chassis Dimensions

The R810 maximum configuration weight is 26.1 kg (57.54 lb).

## 4.3 Front-Panel View and Features



Figure 3. Front-Panel View (without Bezel)

For detailed information, see the Front-Panel Features and Indicators section in the About Your System chapter of the *PowerEdge R810 Hardware Owner's Manual* on [Support.Dell.com/Manuals](http://Support.Dell.com/Manuals).

Dell

The PowerEdge R810 supports the following USB devices:

- DVD (bootable; requires two USB ports)
- USB Key (bootable)
- Keyboard (only one USB keyboard is supported)
- Mouse (only one USB mouse is supported)

## 4.4 Back-Panel View and Features



Figure 4. Back-Panel View

For detailed information, see the Back-Panel Features and Indicators section in the About Your System chapter of the *PowerEdge R810 Hardware Owner's Manual* on [Support.Dell.com/Manuals](http://Support.Dell.com/Manuals).

The following components are located on the back panel of the R810 enclosure:

- 15-pin VGA connector
- DB-9 Serial Port connector
- (4) RJ-45 10/100/1000 Ethernet connectors
- Rear System ID button
- Rear System Status/ID blue/amber LED
- Active ID Cable Management Arm (CMA) external led jack
- Four USB ports
- (Optional) RJ-45 iDRAC6 Enterprise connector
- (Optional) vFlash media slot on iDRAC6 Enterprise

## 4.5 Power Supply Indicators

The power supplies have indicators that show whether power is present or whether a power fault has occurred. See the Power Indicator Codes section in the About Your System chapter of the *PowerEdge R810 Hardware Owner's Manual* on [Support.Dell.com/Manuals](http://Support.Dell.com/Manuals) for more information.

## 4.6 NIC Indicators

See the NIC Indicator Codes section in the About Your System chapter of the *PowerEdge R810 Hardware Owner's Manual* on [Support.Dell.com/Manuals](http://Support.Dell.com/Manuals) for more information.

## 4.7 Rails and Cable Management

The PowerEdge R810 uses the same rails and cable management arm (CMA) as the PowerEdge R910. It does not share rails with other Dell 2U servers. Only sliding ReadyRails™ are offered for the R810. Static ReadyRails are not supported.

Sliding ReadyRails™ for 4-post Racks support the following:

- Toolless installation in 19" EIA-310-E compliant square or unthreaded round hole 4-post racks including all Dell 42xx and 24xx racks (threaded 4-post racks and 2-post racks require Dell's fixed shelf or third-party conversion kits available through Dell Software and Peripherals)



## Dell

- Full extension of the system to allow serviceability of key internal components
- Optional cable management arm (CMA)

Measurements and adjustment ranges for the rack:

- Rail depth without the CMA: 755 mm
- Rail depth with the CMA: 883 mm
- Square-hole rack adjustment range: 686-883 mm
- Round-hole rack adjustment range: 672-876 mm

CMA features include:

- Large U-shaped baskets to support dense cable loads
- Fully reversible (can be mounted on either side) with no conversion required
- Uses hook-and-loop straps rather than plastic tie wraps to eliminate risk of cable damage during cycling
- Includes low profile support tray to eliminate CMA sag
- Both CMA and tray mount toollessly with simple and intuitive snap-in designs

See Section 14 for more information.

## 4.8 Rack View

Rails allow the server to be extended out from the rack for servicing as shown in Figure 5.



Figure 5. Server Extended for Servicing

The CMA (shown in Figure 6) organizes the cords and cables at the back of the server and unfolds to allow the server to extend out from the rack without removing cables.

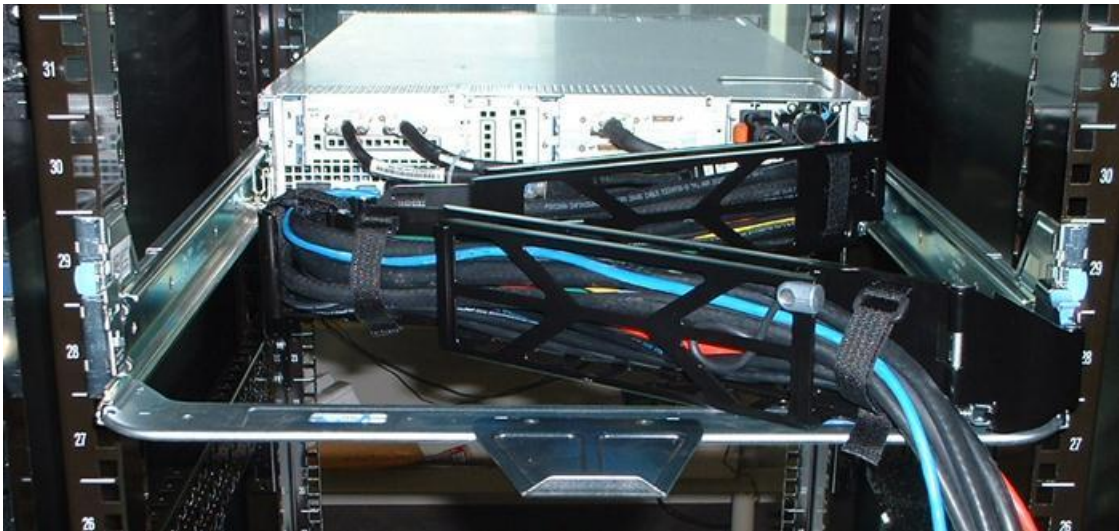

Figure 6. Front and Back Rack-mount and Rail Views Showing CMA and Support Tray

## 4.9 Fans

Six hot-pluggable fans are mounted in a fan gantry that is located in the chassis behind the processors. Each fan has a blind mate 2x2 connector that plugs directly into the planar. There is an additional fan integrated in each power supply to cool the power supply subsystem and also provide additional cooling for the whole system.

The Embedded Server Management logic in the system monitors the speed of the fans. A fan failure or over-temperature in the system results in a notification by iDRAC6. All system fans are pulse width modulated fans. Redundant cooling is supported with one fan failing at a time.

## 4.10 LCD Control Panel

The system control panel is located on the front of the system chassis to provide user access to buttons, display, and I/O interfaces. Features of the system control panel include:

- ACPI-compliant power button with an integrated green power LED (controlled by iDRAC6)
- 128x20 pixel LCD panel with controls:
  - Two navigation buttons
  - One select button
  - One system ID button
- Non-Maskable Interrupt (NMI) button (recessed)
- Ambient temperature sensor
- Two external USB 2.0 connectors (with an internal USB connector and Optional Internal SD Module)
- 15-pin VGA connector

The LCD panel is a graphics display controlled by iDRAC6. Error codes can be sent to the display by either iDRAC6 or BIOS.

BIOS will have the ability to enter a “Secure Mode” through Setup, which will lock the power and NMI buttons. When in this mode, pressing either button has no effect but does not mask other sources of NMI and power control.

The control panel board is connected to the planar via a 60-wire ribbon cable and a separate 5-wire cable for USB signals only. The LCD plugs into the control panel through a 20-pin ZIF connector and flex cable.

## 4.11 Security

### 4.11.1 Cover Latch

A tooled entry latch is provided on the top of the unit to secure the top cover to the chassis. For more information, see the Opening and Closing the System chapter of the *PowerEdge R810 Hardware Owner's Manual* on [Support.Dell.com/Manuals](http://Support.Dell.com/Manuals).

### 4.11.2 Bezel

A metal bezel is mounted to the chassis front to provide the Dell ID. A lock on the bezel is used to protect un-authorized access to system peripherals and the control panel as shown in the Removing the Bezel chapter of the *PowerEdge R810 Hardware Owner's Manual* on [Support.Dell.com/Manuals](http://Support.Dell.com/Manuals). System status on the LCD is viewable even when the bezel is installed. The bezel is optional for R810 systems.

### 4.11.3 Hard Drive

The optional front bezel of the system contains a lock. A locked bezel secures the system hard drives.

### 4.11.4 Trusted Platform Module (TPM)

The TPM is used to generate/store keys, protect/authenticate passwords, and create/store digital certificates. TPM can also be used to enable the BitLocker™ hard drive encryption feature in Windows Server 2008.

TPM is enabled through a BIOS option and uses HMAC-SHA1-160 for binding. A Trusted Computing Module (TCM) version of the planar is available for use where TCM is the standard, for example, in China.

### 4.11.5 Power Off Security

The control panel is designed such that the power switch cannot be accidentally activated. The lock on the bezel secures the switch behind the bezel. In addition, there is a setting in the CMOS setup that disables the power button function.

### 4.11.6 Intrusion Alert

A switch mounted on the left riser board is used to detect chassis intrusion. When the cover is opened, the switch circuit closes to indicate intrusion to Embedded System Management (ESM). When enabled, the software can provide notification to the customer that the cover has been opened. The PowerEdge R810 only supports up to 5 minutes of operation with the cover off.

### 4.11.7 Secure Mode

BIOS has the ability to enter a secure boot mode via Setup. This mode includes the option to lock out the power and NMI switches on the Control Panel or set up a system password.

## 4.12 USB Key

An optional USB memory key installed inside your system can be used as a boot device, security key, or mass storage device. The USB connector must be enabled by the Internal USB Port option in the Integrated Devices screen of the System Setup program.

## 4.13 Battery

A replaceable coin cell CR2032 3V battery is mounted on the planar to provide backup power for the Real-Time Clock and CMOS RAM on the ICH10 chip.

## 4.14 Field Replaceable Units (FRU)

Both planars contain a serial EEPROM to contain FRU information including Dell part number, part revision level, and serial number. The iDRAC6 Enterprise contains a FRU EEPROM. The backplane SEP and the power supply microcontroller are also used to store FRU data.

## 4.15 User Accessible Jumpers, Sockets, and Connectors

For information on user accessible jumpers, sockets, and connectors, see the Jumpers and Connectors chapter of the *PowerEdge R810 Hardware Owner's Manual* on [Support.Dell.com/Manuals](http://Support.Dell.com/Manuals).

## 5 Power, Thermal, Acoustic

### 5.1 Power Subsystem

The Dell™ PowerEdge™ R810 power supply subsystem supports up to two AC-DC power supplies (1+1 redundant configuration) connected directly to the planar. The power supply only provides +12V and +12Vaux. There are several voltage regulators in the system to supply different voltage levels needed by different logic devices.

#### 5.1.1 Power Distribution Board

The Power Distribution Board (PDB) distributes power from the Power Supply Unit (PSU) to the processor and I/O planars. The Power Management bus enables power supply monitoring and load balancing. The processor planar connects directly to the PDB through a 32-pin + 6-blade connector. The I/O planar connects to the PDB through a 12-conductor (2x6) cable. The standby power is routed through the processor planar and I/O planar via Air-max connector.

### 5.2 Power Efficiency





One of the main features of Dell's eleventh-generation family of servers is enhanced power efficiency. The R810 achieves higher power efficiency by implementing the following features:

- User-selectable power cap (subsystems throttle to maintain the specified power cap)
- Improved power budgeting
- Accurate inlet temperature
- Power supply and voltage regulator (VR) efficiency improvements
- Switching regulators instead of linear regulators
- Closed loop thermal throttling
- Increased rear venting and 3D venting
- Pulse width modulated (PWM) fans with an increased number of fan zones and configuration-dependent fan speeds
- Use of DDR3 memory (lower voltage compared to DDR2, UDIMM support)
- Processor VR dynamic phase shedding
- Memory VR static phase shedding
- Random time interval for system start (Allows an entire rack to power on without exceeding the available power)
- BIOS Power/Performance options page
- Active Power Controller (BIOS-based CPU P-state manager)
- Ability to power down or throttle memory
- Ability to disable a processor core
- Ability to turn off embedded NICs or PCIe lanes when not being used
- Option to run PCIe at Gen1 speeds instead of Gen2

### 5.3 Power Supplies

The base redundant system consists of two hot-plug 1100 W power supplies in a 1+1 configuration. R810 power supplies have embedded cooling fans. The power supplies have one status bi-color LED: green for AC power present and amber for a fault.

**Table 3. Power Supply Status Indicator**

LED	Power Supply Status
	AC Power is not present
	AC Power is present
	Fault of any kind is detected
	DC Power is applied to the system
	PSU mismatch (when hot-plugged/swapped)

Factory replaceable unit (FRU) data is stored in the memory of the power supply microcontroller. Additionally, the power supply firmware can be updated by the baseboard management controller (BMC) over the PMBus.

Power is soft-switched, allowing power cycling using a switch on the front of the system enclosure, or through software control (through server management functions).

In a single power supply configuration, the power supply is installed in PS1 location and a blank module (metal cover) is installed in PS2 location for factory consistency. Electrically, the system can operate with a single power supply in either bay.



**Figure 7. Power Supply**

## 5.4 Heat Dissipation

Maximum system heat dissipation is 4012 BTU/Hr.

## 5.5 Environmental Specifications

Table 4 details operating and storage environmental requirements.

**Table 4. Environmental Specifications**

Temperature	
Operating	10°C to 35°C (50°F to 95°F) with a maximum temperature gradation of 10°C per hour Note: For altitudes above 2950 feet, the maximum operating temperature is derated 1°F/550 ft.
Storage	-40°C to 65°C (-40°F to 149°F) with a maximum temperature gradation of 20°C per hour
Relative humidity	
Operating	20% to 80% (noncondensing) with a maximum humidity gradation of 10% per hour
Storage	5% to 95% (noncondensing) with a maximum humidity gradation of 10% per hour
Maximum vibration	
Operating	0.26 Grms at 5-350 Hz in operational orientations
Storage	1.54 Grms at 10-250 Hz in all orientations
Maximum shock	
Operating	Half sine shock in all operational orientations of 31 G +/- 5% with a pulse duration of 2.6 ms +/-10%
Storage	Half sine shock on all six sides of 71 G +/- 5% with a pulse duration of 2 ms +/-10% Square wave shock on all six sides of 27 G with velocity change @ 235 in/sec or greater
Altitude	
Operating	-16 m to 3048 m (-50 ft to 10,000 ft) Note: For altitudes above 2950 feet, the maximum operating temperature is derated 1°F/550 ft.
Storage	-16 m to 10,600 m (-50 ft to 35,000 ft)

## 5.6 ENERGY STAR Compliance

ENERGY STAR® qualified configurations can be accessed from the [ENERGY STAR Compliance results landing page](#) on Dell.com.

## 5.7 Thermal

Key new thermal features for the R810 include the following:

- A high-efficiency fan for better power-to-cooling performance
- Improved closed-loop fan speed control to manage memory subsystem temperatures
- High vent area ratios to enable cooling for the four-socket feature set

These features provide for acoustical output towards the quiet end of data center rack products, as well as producing good sound quality.

The thermal design of the PowerEdge R810 reflects the following:

- Energy Efficient Fans with lower power consumption than previous 2U products.
- Custom Air Baffling directs airflow through the components to maintain proper cooling while improved chassis ventilation ensures sufficient airflow to allow the processor feature set to be deployed in a 2U chassis.
- Custom Design Heat Sinks maintain processor, IOH, and chipset temperatures within thermal-design targets.
- Highly Optimized Fan Control Algorithm:
  - Base fan speeds are a function of hardware configuration and ambient temperature to minimize airflow for a given environment.
  - Closed-loop PID control algorithms are used for both processor and DIMMs to maintain appropriate thermal margin.
  - Double refresh switching allows for DIMM temperature excursions up to 95°C while maintaining performance and thermal-design targets:
    - The R810 thermal algorithm monitors the thermal sensor on each DIMM to maintain DIMM temperatures below the typical 85°C specification in normal operating conditions.
    - Under extreme operating conditions, the thermal algorithm can switch the DIMMs into Double Refresh mode allowing an additional 10°C of thermal headroom. In Double Refresh mode, DIMMs are allowed to operate as high as 95°C.

## 5.8 Acoustics

The acoustical design of the PowerEdge R810 reflects the following:

- **Adherence to Dell's high sound quality standards:** Sound quality is different from sound power level and sound pressure level in that it describes how humans respond to annoyances in sound, like whistles and hums. One of the sound quality metrics in the Dell specification is prominence ratio of a tone, and this is listed in Table 5.
- **Noise levels of configurations:** Hardware configurations have a limited effect on system noise levels. The R810 is noticeably quieter when populating only two processor sockets. Acoustically sensitive users may opt for populating two of the four processor sockets.

The acoustical performance for two-socket and four-socket configurations of the PowerEdge R810 are shown in Table 5.



Table 5. Acoustical Performance

Two-socket Configuration @ 23±2 °C Ambient					Operating Mode	LwA-UL (bels)	LpA (dBA)	Prominent Tones
Processors	Hard Drives	Power Supplies	DIMMs	RAID				
2 x Intel® Xeon® E7540 (105W)	4 x 15K 2.5" SAS	2 x 1100W	32 x 4GB DDR3	PERC H800	Standby	2.8	14	None
					Idle	6.2	43	None
					Stressed processor	6.3	44	None
Four-socket Configuration @ 23±2 °C Ambient					Operating Mode	LwA-UL (bels)	LpA (dBA)	Prominent Tones
Processor	Hard Drives	Power Supply	DIMM	RAID				
4 x Intel Xeon E7540 (105W)	4 x 15K 2.5" SAS	2 x 1100W	32 x 4GB DDR3	PERC H800	Standby	2.8	15	None
					Idle	6.5	47	None
					Stressed processor	6.5	47	None

### Definitions

**Standby:** AC Power is connected to power supplies but the system is not turned on.

**Idle:** Reference ISO7779 (2010) definition 3.1.7; system is running in its OS but no other specific activity.

**Stressed Processor:** An operating mode per ISO7779 (2010) definition 3.1.6. The software SPECPower\_ssj2008 is utilized to stress the processors. SPECPower is set to 50% loading.

**LwA-UL:** The upper limit sound power level (LwA) calculated per section 4.4.2 of ISO 9296 (1988) and measured in accordance to ISO 7779 (2010).

**LpA:** Average bystander A-Weighted sound pressure level. The system is placed in a rack with its bottom at 25 cm from the floor. The acoustic transducers are at the four bystander positions, ref ISO7779 (2010) Section 8.6.2.

**Prominent tones:** Criteria of D.6 and D.11 of ECMA-74 11th ed. (2010) are followed to determine if discrete tones are prominent. The system is placed in a rack with its bottom at 75-cm from the floor. The acoustic transducer is at front bystander position, ref ISO7779 3rd (2010), Section 8.6.2.

**Idle:** Reference ISO7779 (1999) definition 3.1.7; system is running in its OS but no other specific activity.

**Stressed Processor:** An operating mode per ISO7779 (1999) definition 3.1.6. The software SPECPower\_ssj2008 is utilized to stress the processors. SPECPower is set to 50% loading.

**LwA - UL:** The upper limit sound power level (LwA) calculated per section 4.4.2 of ISO 9296 (1988) and measured in accordance to ISO 7779 (1999).

**LpA:** Average bystander A-Weighted sound pressure level. The system is placed in a rack with its bottom at 25 cm from the floor. The acoustic transducers are at the four bystander positions, ref ISO7779 (1999) Section 8.6.2.

Dell

**Prominent tone:** Criteria of D.5 and D.8 of ECMA-74 9th ed. (2005) are followed to determine if discrete tones are prominent. The system is placed in a rack with its bottom at 75 cm from the floor. The acoustic transducer is at front bystander position, ref ISO7779 (1999) Section 8.6.2.

## 5.9 PCI Express Riser Connectors

The R810 requires two PCI Express risers: Riser1 and Riser2. Each riser connects to the planar through a physical x16 PCI Express connector with Dell custom pin-out. For more information, see the Expansion Cards and Expansion-Card Risers chapter of the *PowerEdge R810 Hardware Owner's Manual* on [Support.Dell.com/Manuals](http://Support.Dell.com/Manuals).

## 5.10 Super I/O Controller

The R810 system planar uses an SMSC LPC47M534 Super I/O controller to provide support for the serial port and the keyboard controller. The LPC47M534 is a Plug-and-Play compatible device that interfaces directly to the ICH10 through the LPC bus.

## 6 Processors

### 6.1 Overview

The Intel® Xeon® processor 6500 and 7500 series and the Intel Xeon processor E7 product family are designed specifically for servers and workstation applications. The processor features quad-core processing to maximize performance and performance/watt for data center infrastructures and highly dense deployments. These processors also feature Intel® Core™ micro-architecture and Intel® 64 architecture for flexibility in 64-bit and 32-bit applications and operating systems. The Intel Xeon processor 6500 and 7500 series and the Intel Xeon E7-2800, E7-4800, and E7-8800 product family support all Streaming SIMD Extensions (including SSE2, SSE3, and SSE4) and Intel 64 instruction.

The Intel Xeon processor 6500 and 7500 series 4S (expandable processor) use a 1567-pins Land Grid Array (LGA1567) package that plugs into a surface-mount socket. The R810 provides support for two or four processors.

### 6.2 Features

Key features of the Intel Xeon E7-2800, E7-4800, and E7-8800 product family include:

- Up to ten cores per processor
- Four point-to-point QuickPath Interconnect links at 6.4 GT/s
- 32 nm process technology
- Intel HyperThreading (2 threads/core)
- Up to 30 MB shared L3 cache
- Intel Trusted Execution Technology (TXT) and AESNI (AES New Instructions)
- RAS DDDC (Double Device Data Correct)

Key features of the Intel Xeon processor 6500 and 7500 series include:

- Up to eight cores per socket
- Up to 24 MB shared L3 cache
- 45 nm process technology
- Four full-width, bidirectional point-to-point Intel QuickPath Interconnect (Intel® QPI) links at 6.4 GT/s
- Support for 95W, 105W, and 130W processors
- Four Intel Scalable Memory Interconnects (Intel SMI) at 6.4 GT/s
- Socket: LS, LGA 1567 package
- No termination required for non-populated processors (must populate processor socket 1 first)
- Integrated Intel QuickPath DDR3 memory controller
- 64-byte cache line size
- RISC/CISC hybrid architecture
- Compatible with existing x86 code base
- Optimized for 32-bit code
- MMX support
- Execute Disable Bit
- Intel Wide Dynamic Execution
- Executes up to four instructions per clock cycle
- Simultaneous Multi-Threading (SMT) capability (2 threads/core)
- Support for CPU Turbo Mode (on certain models)
- Increases processor frequency if operating below thermal, power, and current limits
- Streaming SIMD (Single Instruction, Multiple Data) Extension 4
- Intel 64 Technology

Dell

- Intel VT-x and VT-d Technology for virtualization support
- Enhanced Intel® SpeedStep Technology
- Demand-based switching for active processor power management as well as support for ACPI P-States, C-States, and T-States

## 6.3 Supported Processors

**Table 6. Supported Intel Xeon E7-8800 Product Family**

Model	Speed	TDP Power	Cache	Cores	QPI Speed
E7-8870	2.40GHz	130W	30M	10	6.4GT/s
E7-8867L	2.13GHz	105W	30M	10	6.4GT/s
E7-8860	2.26GHz	130W	24M	10	6.4GT/s
E7-8850	2.00GHz	130W	24M	10	6.4GT/s
E7-8837	2.66GHz	130W	24M	8	6.4GT/s
E7-8830	2.13GHz	105W	24M	8	6.4GT/s

**Table 7. Supported Intel Xeon E7-4800 Product Family**

Model	Speed	TDP Power	Cache	Cores	QPI Speed
E7-4870	2.40GHz	130W	30M	10	6.4GT/s
E7-4860	2.26GHz	130W	24M	10	6.4GT/s
E7-4850	2.00GHz	130W	24M	10	6.4GT/s
E7-4830	2.13GHz	105W	24M	8	6.4GT/s
E7-4820	2.00GHz	105W	18M	8	5.86GT/s
E7-4807	1.86GHz	95W	18M	8	4.80GT/s

**Table 8. Supported Intel Xeon E7-2800 Product Family**

Model	Speed	TDP Power	Cache	Cores	QPI Speed
E7-2870	2.40GHz	130W	30M	10	6.4GT/s
E7-2860	2.26GHz	130W	24M	10	6.4GT/s
E7-2850	2.00GHz	130W	24M	10	6.4GT/s
E7-2830	2.13GHz	105W	24M	8	6.4GT/s
E7-2820	2.00GHz	105W	18M	8	5.86GT/s
E7-2803	1.73GHz	105W	18M	6	4.80GT/s

**Table 9. Supported Intel Xeon Processor 6500 and 7500 Series**

Model	Speed	TDP Power	Cache	Cores	QPI Speed
X7560	2.26GHz	130W	24M	8	6.4GT/s
X6550	2.00GHz	130W	18M	8	6.4GT/s

Model	Speed	TDP Power	Cache	Cores	QPI Speed
L7555	1.86GHz	95W	24M	8	5.86GT/s
X7542	2.66GHz	130W	18M	6	5.86GT/s
E7540	2.00GHz	105W	18M	6	6.4GT/s
E6540	2.00GHz	105W	18M	6	6.4GT/s
L7545	1.86GHz	95W	18M	6	5.86GT/s
E7520	1.86GHz	95W	18M	4	4.8GT/s
E6510	1.73GHz	105W	12M	4	4.8GT/s

## 6.4 Processor Configurations

The Dell™ PowerEdge™ R810 is designed to support either a dual-processor configuration with FlexMem Bridge or a four-processor configuration. In either configuration, all IO and memory is available in the system. While not formally supported, single processor configurations with a processor installed in CPU1 will allow the system to boot for diagnostic purposes.

Due to power limitations, the PowerEdge R810 will support only two X7560 (130W) processors, however, up to four 130W Intel Xeon E7-2800, E7-4800, or E7-8800 product family processors are supported if LVDIMMs are installed. In an upgrade for a server with two 130W processors, the processors and the heat sinks must be changed to the 95W or 105W processors. If the server has only the 95W or 105W processors, they can simply be swapped out.

The Intel Xeon processor 6500 series is for two-socket configurations only and cannot be upgraded to a four-socket configuration.

## 6.5 FlexMem Bridge

In a four-processor configuration, the PowerEdge R810 uses only one memory controller per processor. This single controller connects to two memory buffers via Intel SMI links. Each memory buffer in turn connects to four DDR3 DIMMs. In a typical configuration, only the memory buffers associated with the two populated sockets would be connected, and therefore only 16 DIMMs would be accessible.

To overcome this limitation with two processors, the R810 uses the FlexMem Bridge that allows CPU1 and CPU2 to connect to the memory of their respective adjacent sockets (CPU3 and CPU4). The FlexMem Bridge provides the following:

- Two pass-through links for SMI
- One pass-through link for QPI

The pass-through SMI links connect the two installed processors to additional SMIs, therefore the processors will have the following memory attached:

- CPU1 will have access to DIMMs [A1:A8], plus DIMMs [C1:C8] (those normally associated with CPU3)
- CPU2 will have access to DIMMs [B1:B8], plus DIMMs [D1:D8] (those normally associated with CPU4)

The pass-through QPI link on the FlexMem Bridge provides increased performance for a 2P configuration because it allows two full-bandwidth QPI links between CPU1 and CPU2 as opposed to a single link. Figure 8 depicts the interconnection between the processor sockets as well as connections internal to the FlexMem Bridges. The FlexMem Bridges are only supported in sockets 3 and 4.

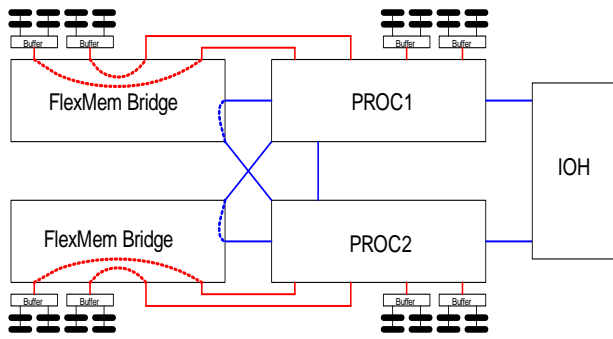

Figure 8. Diagram of FlexMem Bridge Routing

Modern processors are capable of tremendous workloads, and many types of utilization patterns such as virtualization often run into memory capacity issues well before the processors reach a saturation point. FlexMem Bridge technology was designed to assist those customers that have workloads that are memory intensive.

## 7 Memory

### 7.1 Overview

The Dell™ PowerEdge™ R810 uses DDR3 memory providing a high-performance, high-speed memory interface capable of low latency response and high throughput. The R810 supports Registered ECC DDR3 DIMMs (RDIMM).

The DDR3 memory interface consists of eight Intel® E7510 Scalable Memory Buffers (SMBs), each of which has two DDR3 memory channels. Each channel supports up to two RDIMMs for single/dual/quad rank. By limiting each channel to two DIMMs per DDR channel, the system can support quad-rank DIMMs at 1066 MHz.

The R810 memory interface supports memory demand and patrol scrubbing as well as single-bit correction and multi-bit error detection. Correction of a x4 or x8 device failure (“chip kill”) is supported with Single Device Data Correction (SDDC). The following properties/rules apply to R810:

- DIMMs must be populated in matched pairs for each processor (such as A1/A2, A3/A4). Single DIMM operation is not supported.
- If DIMMs of different speeds are mixed, all channels will operate at the fastest common frequency. (The R810 supports up to 1066 MHz memory speed.)

Memory Mirroring and Sparing configurations is supported as follows:

- Memory sparing will be allowed on configurations with  $\geq$  64GB populated
- Memory mirroring will be enabled on configurations with 32 DIMMs populated

The first DIMM slot in each channel is color-coded with white ejection tabs for ease of installation.

In the case of mixed-rank population, populate the DIMM with the highest number of ranks first (in sockets with white ejection tabs).

The DIMM sockets are placed 440 mils (11.12 mm) apart, center-to-center in order to provide enough space for sufficient airflow to cool stacked DIMMs.

DIMMs must be installed in each channel starting with the DIMM farthest from the SMB. Population order will be identified by the designator on the system board and the System Information Label (SIL) located on the chassis cover.

### 7.2 DIMMs Supported

R810 supports RDIMMs only, running at 1066 MHz. DIMMs rated at 1333 MHz are supported running at 1066 MHz. DIMM capacities of 1GB, 2GB, 4GB, 8GB and 16GB are supported.

Single-, dual-, and quad-rank DIMMS are supported. LV DIMMs are not supported.

### 7.3 Memory System Key Features

Registered (RDIMM) ECC DDR3 technology features support:

- Carrying of 64 data and 8 ECC bits for each channel
- Up to 512 GB of memory (with 32 16GB RDIMMs)
- 1066 MHz single-, dual-, and quad-rank DIMMs
- ODT (On Die Termination)
- Clock gating (CKE) to conserve power when DIMMs are not accessed
- Low power self-refresh mode for DIMMs
- I<sup>2</sup>C access to SPD EEPROM for access to RDIMM thermal sensors
- Single-Bit Error Correction

Dell

- SDDC (Single Device Data Correction—x4 or x8 devices)
- Support for Closed Loop Thermal Management on RDIMMs
- Multi-Bit Error Detection
- Support for Memory Mirroring in limited configurations
- Support for Memory (Rank) Sparring in limited configurations

## 7.4 Memory Speed Limitations

The memory frequency is determined by a variety of inputs:

- Speed of the DIMMs
- Speed supported by the processor (note the DDR3 speed is 1/6 the frequency of the SMI link)
- BIOS can limit frequency to DDR3 800 based on user power savings configuration in the SETUP menu

The R810 supports DDR3 speeds up to 1066 MHz. DIMMs rated at 1333 MHz are supported running at 1066 MHz. Some processors will have lower SMI link speeds resulting in slower DDR3 busses.

Supported frequencies are as follows:

- SMI link speed at 4.8GT/sec => DDR3 800 MHz
- SMI link speed of 5.86 GT/sec => DDR3 978 MHz
- SMI link speed of 6.4 GT/sec => DDR3 1066 MHz

For quad-rank DIMMs mixed with single- or dual-rank DIMMs, the quad-rank DIMM needs to be in the slot with the white ejection tabs (the first DIMM slot in each channel). There is no requirement for the order of SR and DR DIMMs.

## 7.5 DIMM Slots

The R810 has all DIMM slots directly on the motherboard. There are no memory risers.

Refer to Figure 9 for the memory layout. DIMMs A1-A8 correspond to CPU1, DIMMs B1-B8 correspond to CPU2, and so on. In the case where two processors and 2 FlexMem Bridges are installed, DIMMs C1-C8 will associate with CPU1, and DIMMs D1-D8 will associate with CPU2.



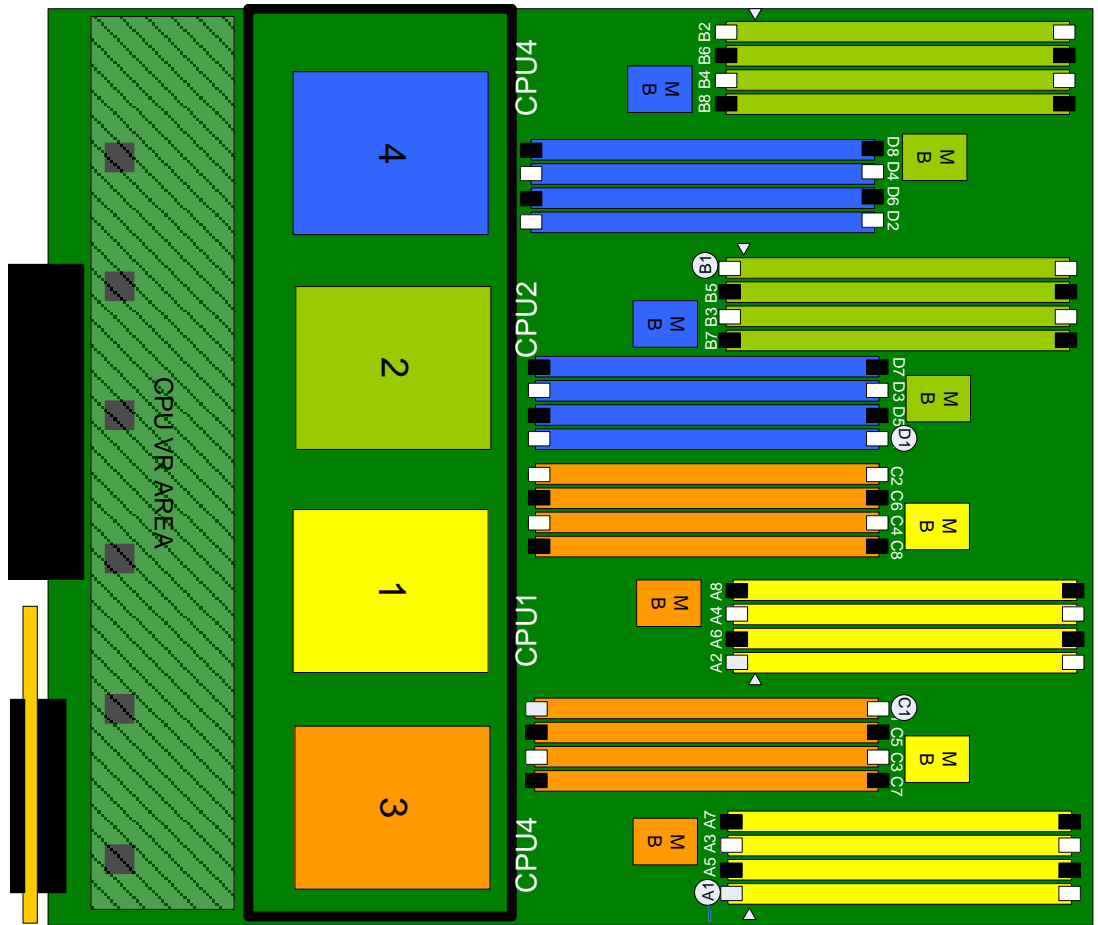

Figure 9. DIMM Naming and Numbering

## 7.6 Memory Access

See the System Memory chapter of the *PowerEdge R810 System Hardware Owner's Manual* located on [Support.Dell.com/Manuals](http://Support.Dell.com/Manuals) for information.

## 7.7 Memory RAS Support

The Intel® Xeon® processor 6500 and 7500 series and the Intel Xeon E7-2800, E7-4800, and E7-8800 product family support high-availability memory modes including rank and DIMM sparing as well as memory mirroring. The R810 supports rank sparing only and mirroring as shown in Table 10.

Table 10. PowerEdge R810 Sparing and Mirroring

Sparing		Mirroring			
Type	Rules enforced	1P	2P	4P	Rules Enforced
Rank	The capacity of the spare rank must be greater than that of any other rank on the channel	No support	Inter-socket (hemisphere mode enabled)	Inter-socket	32 DIMM only, Mirrored must match

### 7.7.1 Sparing

For Rank sparing, one rank on each lockstep Intel 7500 SMB pair will be reserved as a spare, and in the event that another rank exceeds a threshold of correctable ECC errors, the “failing” rank will be copied to the spare. Once that operation is complete, the failed rank will be disabled.

### 7.7.2 Mirroring

For mirroring, the R810 will support 2P/4P configurations with 32 DIMMs only. When mirroring is enabled, only half of the physical memory will be visible to the system software. A full copy of the memory is maintained, and in the event of an uncorrectable error, the system will switch over to the mirrored copy. In 2P mode, the mirroring will be inter-node with hemisphere mode enabled. In this case, the memory controller (MBox) of CPU1 is mapped to the corresponding MBox of CPU2. The figure below depicts the mirroring logic for 2P configurations. A, B, C and D represent the DIMM socket groups.

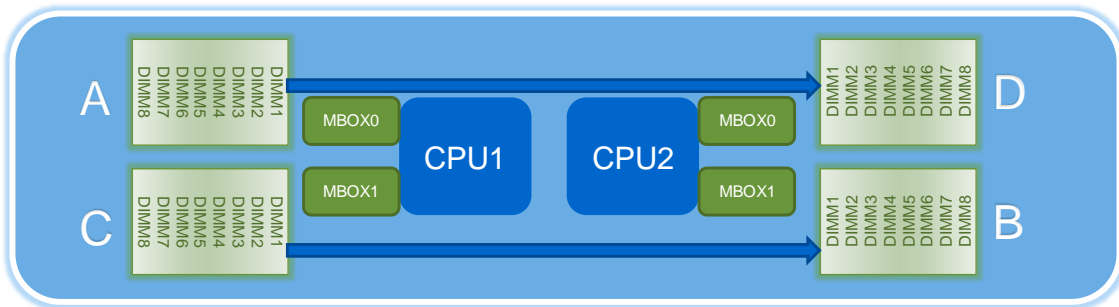

Figure 10. 2P Mirroring

For four-processor configurations, the PowerEdge R810 will also support mirroring in the inter-socket mode (note that intra-socket is not possible in 4P because each processor has only one MBox connected to memory buffers). In this 4P case, the memory on CPU1 will be mirrored with memory on CPU3, while memory on CPU2 is mirrored with memory on CPU4. Table 10 depicts the mirroring logic for 2P configurations. A,B,C and D represent the DIMM socket groups.

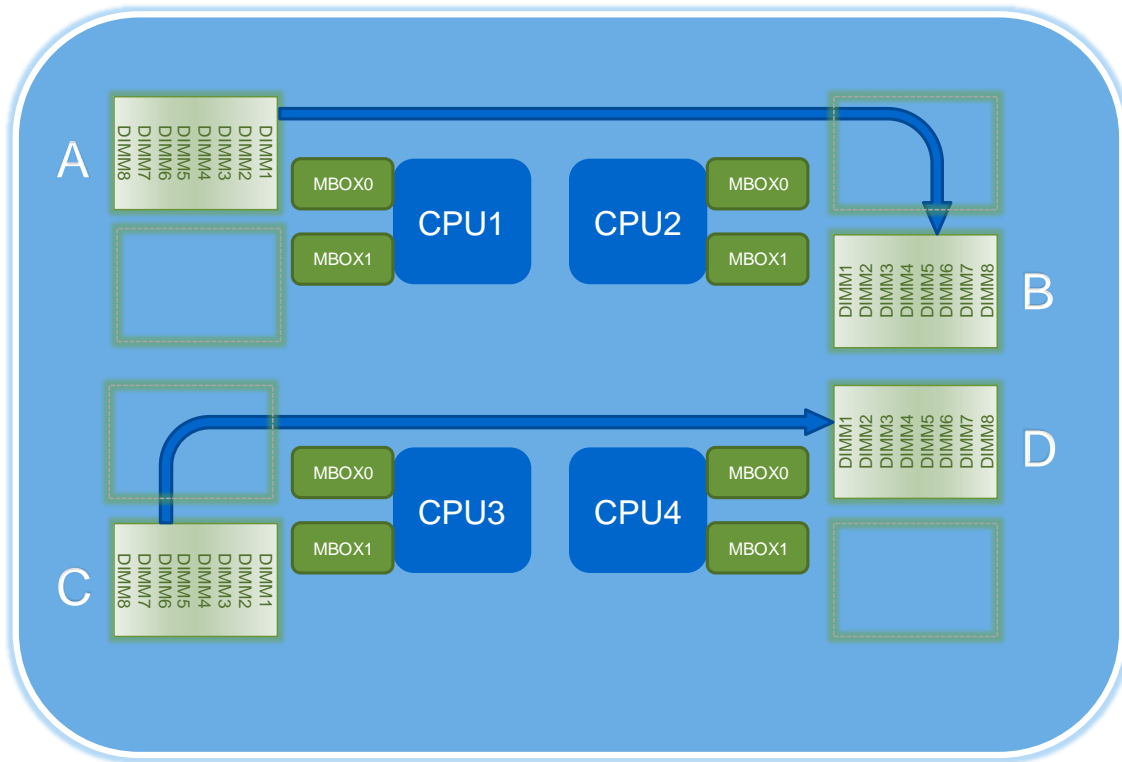

Figure 11. 4P Mirroring

## 7.8 Memory RAID

Memory RAID is not supported on the PowerEdge R810.

## 7.9 Supported Configurations

See the System Memory section in the Installing System Components chapter in the *Dell PowerEdge R810 Systems Hardware Owner's Manual* on [Support.Dell.com/Manuals](http://Support.Dell.com/Manuals).

## 8 Chipset

### 8.1 Overview

The Dell™ PowerEdge™ R810 system board incorporates the Intel® 7500 chipset for I/O and processor interfacing. The 7500 chipset is designed to support the Intel® Xeon® processor 6500 and 7500 series and the Intel Xeon processor E7 product family, Intel® QPI Interconnect, DDR3 memory technology, and PCI Express Generation 2 (PCIe 2). The 7500 chipset consists of the IOH QuickPath Interconnect (QPI), Intel® E7510 Scalable Memory Buffer, and the ICH10 South Bridge.

### 8.2 Intel 7500 Chipset I/O Hub (IOH)

The R810 system board uses the Intel 7500 series IOH to provide a link between the processor(s) and I/O components. The main components of the IOH consist of two full-width QuickPath Interconnect (QPI) links (to processor 1 and 2), 36 lanes of PCI Express Gen2, and a x4 Enterprise Southbridge Interface (ESI) and an integrated IOxAPIC.

### 8.3 IOH PCI Express (PCIe)

PCI Express is a serial point-to-point interconnect for I/O devices. PCIe Generation 2 doubles the signaling bit rate of Generation 1 from 2.5 Gb/s to 5 Gb/s. Each of the PCIe Gen2 ports are backwards-compatible with Gen1 transfer rates.

The IOH has 36 PCI Express lanes. The lanes are partitioned as follows:

- 2 PCI Express Gen2 x2 ports—on-board network controllers
- 4 PCI Express Gen2 x8 ports—I/O expansion slots

### 8.4 Enterprise Southbridge Interface (ESI)

The ESI connects the IOH with the Intel I/O Controller Hub ICH10. The ESI is equivalent to a x4 PCIe Gen1 link with a transfer rate of 1 GB/s in each direction.

### 8.5 Intel I/O Controller Hub 10 (ICH10)

ICH10 is a highly integrated I/O controller, supporting the following functions:

- PCI Bus 32-bit Interface Rev 2.3 running at 33 MHz
- Serial ATA (SATA) ports with transfer rates up to 300 MB/s
- On the R810, one SATA port for optical devices or tape backup
- Six UHCI and two EHCI (high-speed 2.0) USB host controllers, with up to 12 USB ports (R810 uses six of these ports for internal and external use.)
- Power management interface (ACPI 3.0b compliant)
- Platform Environmental Control Interface (PECI) (The iDRAC controls the PEFI interface on R810, not the ICH10.)
- I/O interrupt controller
- SMBus 2.0 controller
- Low Pin Count (LPC) interface to Super I/O, Trusted Platform Module (TPM), and SuperVU
- Serial Peripheral Interface (SPI) support for up to two devices (The R810 BIOS is connected to the ICH10 using SPI interface.)

## 9 BIOS

### 9.1 Overview

The Dell™ PowerEdge™ R810 BIOS is based on the Dell BIOS core, and supports the following features:

- IA-32 Intel® Xeon® 7500 chipset 4S
- Simultaneous Multi-Threading (SMT) support
- Processor Turbo Mode support
- PCI 2.3 compliant
- Plug-and-Play 1.0a compliant
- MP (Multiprocessor) 1.4 compliant
- Boot from hard drive, optical drive, iSCSI drive, USB key, and SD card
- ACPI
- Direct Media Interface (DMI)
- PXE and WOL support for on-board NICs
- Memory mirroring and sparing
- SETUP access through <F2> key at end of POST
- USB 2.0 (USB boot code is 1.1 compliant)
- F1/F2 error logging in CMOS
- Virtual KVM, CD, and floppy support
- Unified Server Configurator (UEFI 2.1) support
- Power management including DBS, Power Inventory and multiple Power Profiles

The R810 BIOS does not support the following:

- Embedded Diagnostics
- BIOS language localization
- BIOS recovery after bad flash (but can be recovered from iDRAC6 Express)

### 9.2 Supported ACPI States

The PowerEdge R810 supports all of the available C-States. See [ACPI.info](http://ACPI.info) for more information.

## 10 Embedded NICs/LAN on Motherboard (LOM)

The Dell™ PowerEdge™ R810 LOM solution consists of Embedded Gigabit Ethernet Controllers with TCP Offload Engine (TOE) and iSCSI support. Four Gigabit Ethernet ports are provided as standard.

Two embedded Broadcom 5709C dual-port LAN controllers are on the R810 planar as independent Gigabit Ethernet interface devices. The following information details the features of the LAN devices:

- x4 PCI Express Gen2 capable interface (R810 operates this controller at Gen2 speed.)
- Integrated MAC and PHY
- 3072x18 Byte context memory
- 64 KB receive buffer
- TOE (TCP Offload Engine enabled as standard)
- iSCSI controller (enabled as standard)
- RDMA controller (RNIC)
- NC-SI (Network Controller-Sideband Interface) connection for manageability
- Wake-On-LAN (WOL)
- PXE 2.0 remote boot
- iSCSI boot
- IPv4 and IPv6 support
- Bare metal deployment support

## 11 PCI Slots

### 11.1 Overview

The Dell™ PowerEdge™ R810 comes standard with a total of six PCIe Gen2 expansion card slots, plus one dedicated slot for the internal RAID controller.

### 11.2 Quantities and Priorities

See the Expansion Cards and Expansion-Card Risers chapter of the *PowerEdge R810 Hardware Owner's Manual* on [Support.Dell.com/Manuals](http://Support.Dell.com/Manuals) for detailed information on expansion card slot priorities and maximum number allowed.

#### 11.2.1 I/O Planar PCI Express Slots

Two low-profile PCI Express slots are provided on the I/O planar. These slots are connected to a PEX8624 Gen2 switch on the I/O Planar, with a x8 upstream link to the IOH.

- Slot3: Physical x8 (x8 electrical) PCI Express Gen2 slot
- Slot4: Physical x8 (x8 electrical) PCI Express Gen2 slot
- NC-SI cable header for NC-SI supported NICs

#### 11.2.2 PCI Express Risers

The two R810 PCI Express risers provide up to four expansion slots and one internal slot as follows:

- Riser1 (Center):
  - (1) Physical x16 (x8 electrical) PCI Express Gen2 slot
    - Slot1 (top)
  - (1) Physical x8 (x4 electrical) PCI Express Gen2 slot
    - Slot2 (bottom)
  - (1) Storage adapter (physical x8, x4 electrical) PCI Express Gen2 slot
    - SASX4 Slot (internal, accommodates internal controllers with no sled)
  - All slots are controlled from the PEX8642 PCIE Gen2 arbiter
- Riser2 (Left):
  - (2) Physical x16 (x8 electrical) PCI Express Gen2 slots
    - Slot5 (top)
    - Slot6 (bottom)
  - Both slots are controlled from the IOH PCIE Gen2 arbiter

Each slot can support full-height, 9.5" long PCI Express except slot 2 (low profile, full-height bracket cards only). The system supports 25W maximum power for the 1<sup>st</sup> and 2<sup>nd</sup> cards and 15W for the 3<sup>rd</sup> through 6<sup>th</sup> cards. The lower power support on the third through sixth cards is due to system thermal limitations

#### 11.2.3 Additional Riser Restrictions

The riser connectors on the IO Board do not support plugging in a standard PCI Express card. Do not attempt this for troubleshooting.

Two R810 risers must be installed or the system will not power up.

- Standard height (4.376")
- Maximum length of 9.5" (Half-length cards are 6.6", full-length cards are 12.283")
- No support for hot-plug or hot-removal
- Compliant with the PCI Express Card Electromechanical Specification Rev 2.0

Dell

- R810 provides a minimum transverse air velocity of 100 LFM (linear feet per minute) to the x16 card

For more information, please refer to the following specifications:

- PCI Express Base Specification, Rev 2.0, 12/20/06
- PCI Express Card Electromechanical Specification, Rev 2.0, 4/11/07
- PCI Express x16 Graphics 150W-ATX Specification, Rev 1.0, 10/25/04
- PCI Environmental Specification (Dell Part Number CC172), Rev A00, 2/14/05

## 11.3 Boot Order

System boot order is settable in the BIOS.

## 11.4 NICs and External Controller Cards

For information on supported NICs and external controller cards, see the Expansion Cards and Expansion-Card Risers chapter of the *PowerEdge R810 Hardware Owner's Manual* on [Support.Dell.com/Manuals](http://Support.Dell.com/Manuals).



## 12 Storage

### 12.1 Overview

The Dell™ PowerEdge™ R810 supports up to six of the following 2.5” hard disk drives:

- 2.5” SATA SSD
- 2.5” SAS (15K, 10K)
- 2.5” nearline SAS (7.2K)
- 2.5” SATA (7.2K)

Internal Storage adapters do not allow mixing of drive types within the same container. Table 11 shows the possible mixing configurations for hard drive types.

**Table 11. Mixing of Drive Types**

Drive Type	SAS HDD	SATA HDD	SATA SSD
SAS HDD	Yes	No	Yes
SATA HDD	No	Yes	No
SATA SSD	Yes	No	Yes

The system backplane does allow mixed drive types as follows:

- Mixed hard-drive configurations of SAS and SATA drives are allowed. In this configuration, two SAS drives must be installed in hard-drive slots 0 and 1 only. The remaining slots can have SATA drives installed.
- Mixed hard-drive configurations of SSD and SAS drives are allowed. In this configuration, two SSD drives must be installed in hard-drive slots 0 and 1 only. The remaining slots can have SAS drives installed.

For the slots that are not occupied by drives, a carrier blank is provided to maintain proper cooling, maintain a uniform appearance to the unit, and provide EMI shielding.

The system supports diskless configuration with no integrated SAS storage controller installed in the system. The 2.5” HDD backplane is still installed in this configuration.

### 12.2 Persistent Storage

R810 offers two types of persistent storage: managed and unmanaged.

#### 12.2.1 iDRAC6 Express

The iDRAC6 Express is a managed persistent storage space for server provisioning data. iDRAC6 Express consists of 1 GB flash and vFlash media (an optional external SD card on the optional iDRAC6 Enterprise). vFlash media offers the hot-plug portability and increased storage capacity benefits of SD while still being managed by the system.

iDRAC6 Express is partitioned to support the following applications:

- **Unified Server Configurator Browser and System Services Module (SSM) (25 MB):** the Unified Server Configurator browser provides a consistent graphical user interface for bare metal deployment and is ideal for 1-to-1 deployment. The SSM supports automatic 1-to-Many deployment.
- **Service Diagnostics (15 MB):** formerly on the hard drive as the Utility Partition, this is a bootable FAT16 partition for Service Diagnostics
- **Deployment OS Embedded Linux® (100 MB):** Storage space to hold Embedded Linux
- **Deployment OS Windows® Preinstallations Environment (PE) (200 MB):** Storage space to hold Windows PE
- **Driver Store (150 MB):** holds all files required for OS deployment
- **iDRAC6 firmware (120 MB):** holds the two most recent versions of iDRAC6 firmware
- **Firmware Images (160 MB):** holds the two most recent versions of BIOS, RAID, embedded NIC, power supplies and hard drive firmware (This partition also holds the BIOS and option ROM configuration data.)
- **Life Cycle Log (2 MB):** stores initial factory configuration as well as all detectable hardware and firmware changes to the server since its deployment. The Life Cycle Log is stored on the BMC SPI flash.

Approximately 20% of the flash space is reserved for wear leveling on the NAND flash. Wear leveling is a method designed to extend the life of the NAND flash by balancing the use cycles on the flash's blocks.

## 12.2.2 Unmanaged Persistent Storage

### 12.2.2.1 General

The unmanaged persistent storage consists of two options: one located on the control panel board and one located on the Internal Dual SD Module. The port on the control panel is for an optional USB key and is located inside the chassis. Some of the possible applications of the USB key are:

- User custom boot and pre-boot OS for ease of deployment or diskless environments
- USB license keys for software applications
- Storage of custom logs or scratch pad for portable user-defined information (not hot-pluggable)

### 12.2.2.2 Internal Dual SD Module

The Internal Dual SD Module (shown in Figure 12) was developed in response to customer concerns about single-SD-card based embedded hypervisor potentially being a single point of failure. Dell designed a fully redundant module which uses two SD cards in a fully mirrored mode. If one card fails, the module issues an alert (no longer redundant) and continues to function with the surviving SD card. This allows the customer to gracefully bring down the hardware node to restore redundancy without any interruption to the supported virtual machines (VMs).

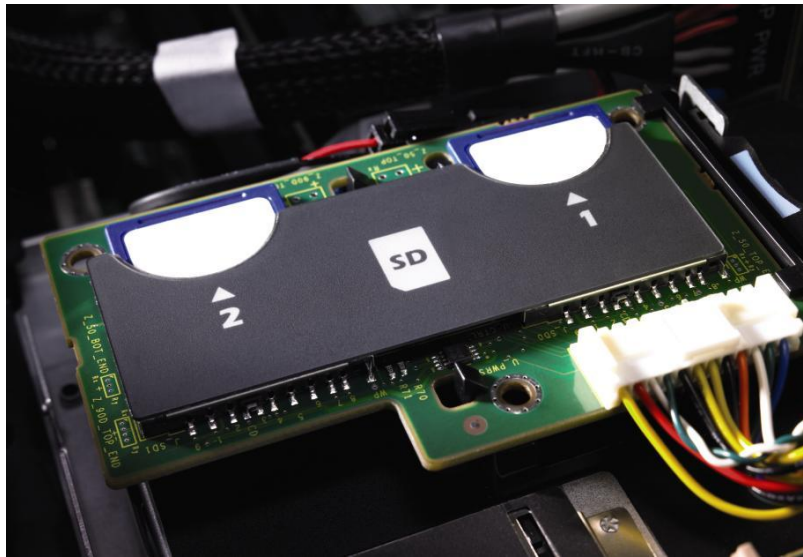

Figure 12. Internal Dual SD Module Shown with a Single Card

The internal SD module is dedicated for an SD flash card with embedded hypervisor for virtualization. The SD flash card contains a bootable OS image for virtualized platforms. The microcontroller has a USB 2.0 interface to the control panel (via 1x12 cable) and SD card controller that interfaces the SD Flash Cards. When two SD Flash Cards are used, the controller can use the two flash cards as redundant configuration. If the system detects that one SD card has failed, the system will flag that failure and continue operating using the second SD card.

### 12.2.3 Flash BIOS memory

A flash EEPROM resides on the Serial Peripheral Interface (SPI) Bus for BIOS and configuration storage. A 4 MB device is utilized for this function. The flash memory permits the BIOS to be upgraded in the field. The flash BIOS may be write-protected by software.

## 12.3 Backplane

The PowerEdge R810 supports six 2.5” hard drives with the 6Gb/s SAS backplane.

On the backplane are two LED indicators per drive slot with two mini-SAS x4 cable connectors for connecting the backplane to the integrated PERC/SAS card and a power connector that connects from backplane to the processor planar.

Serial Attached SCSI (SAS) & SATA hard drives and SATA SSD drives are supported.

## 12.4 Supported Drives

R810 and available controllers will support both 3 GB and 6 GB drives. Only 6 GB drives will be available from the factory where both throughputs are supported.

Table 12. Supported Drives for R810

Form Factor	Capacity	Speed	Type	Throughput
2.5”	50GB	—	SATA SSD	3GB
2.5”	10GB	—	SATA SSD	3GB
2.5”	73GB	15K	SAS	3GB/6GB

Form Factor	Capacity	Speed	Type	Throughput
2.5"	146GB	15K	SAS	3GB/6GB
2.5"	146GB	10K	SAS	3GB/6GB
2.5"	300GB	10K	SAS	3GB/6GB
2.5"	600GB	10K	SAS	6GB
2.5"	160GB	7.2K	SATA	3GB
2.5"	500GB	7.2K	Nearline SAS	6GB

## 12.5 RAID Configurations

The PowerEdge R810 supports the RAID configurations shown in the following tables.

**Table 13. Single Drive Type RAID Configurations**

Config Type	Configs		Description	Min HDD	Max HDD
No HDD	0	NZC	No controller/No hard drive	2.5" = 0	2.5" = 0
SAS/SATA/SSD— No RAID	1	MSS	Integrated SAS/SATA: PERC H200, No RAID	2.5" = 1	2.5" = 6
SAS/SATA/SSD RAID	2	MSSR0	Integrated SAS/SATA RAID 0 ( PERC H700, PERC H200)	2.5" = 2	2.5" = 6
	3	MSSR1	Integrated SAS/SATA RAID 1 (PERC H700, PERC H200)	2.5" = 2	2.5" = 2
	4	MSSR5	Integrated SAS/SATA RAID 5 ( PERC H700)	2.5" = 3	2.5" = 6
	5	MSSR1/R5	Integrated SAS/SATA RAID 1/RAID 5 (PERC H700)	2.5" = 2 + 3	2.5" = 2 + 4
	6	MSSR10	Integrated SAS/SATA RAID 10 (PERC H700, PERC H200)	2.5" = 4	2.5" = 6

Table 14. Mixed SSD and SAS RAID Configurations

Config Type	Configs		Description	Mixed SSD/SAS Min 2xSSD+2xSAS 2.5": Max 2xSSD + 4xSAS	
				Min	Max
SSD/SAS RAID	7	MSSR1/R1-X	Integrated SSD/SAS RAID 1/RAID 1 (PERC H700)	2.5" = 2 + 2	2.5" = 2 + 2
	8	MSSR1/R5-X	Integrated SSD/SAS RAID 1/RAID 5 (PERC H700)	2.5" = 2 + 3	2.5" = 2 + 4
	9	MSSR1/R10-X	Integrated SSD/SAS RAID 1/RAID 10 (PERC H700)	2.5" = 2 + 4	2.5" = 2 + 4

## 12.6 Storage Controllers

### 12.6.1 PERC H200

The H200 SAS HBA is an expansion card that plugs into the dedicated internal SAS slot on Riser1. It incorporates two four-channel 6Gb/s SAS IOCs for connection to SAS hard disk drives. It is designed in a form factor that allows the same card to be used in other 11G 2U rack-form factor platforms.

### 12.6.2 PERC H700

This H700 card has its own processor with a Gen2 PCI Express host interface and DDR2 memory and plugs into the dedicated internal SAS slot on Riser1. A battery is also available for back-up. It supports the internal 6Gb/s SAS backplane interface for internal storage options (SAS, SATA, or SSD HDD). The PowerEdge R810 supports both 256MB and 512MB cache options on the internal H700.

### 12.6.3 PERC H800

R810 can support up to two PERC 800 adapter cards for access to external SAS direct-attach storage. Features of the PERC H800 include:

- LSI 2108 (Liberator) ROC
- 6Gb/s SAS
- x8 PCIe Gen2
- 800Mz Core PPC
- DDRII 800MHz mini-DIMM
- 512 MB battery-backed write cache or 512 MB or 1 GB NV RAM-backed cache
- Dual mini-SAS Connectors

**Table 15. Storage Card Support Matrix**

	Product	Usage	R810 Support	Slot	PCI Con	PCI Bracket	IO Con	RAID	Battery Backup
PERC SAS/SATA	PERC H700 Integrated	Internal Backplane Storage RAID (HDD, SSD)	Yes—Max 1	Storage Slot	x8	No	x4 int x2 int	0, 1, 5, 6, 10, 50, 60	Yes
	PERC H800	External SAS/SATA Storage	Yes—Max 2	PCIe slot	x8	Yes	x4 ext x4 ext	0, 1, 5, 6, 10, 50, 60	Yes
SAS HBA SAS/SATA	H200	Internal Backplane Storage (No tape nor SSD support)	Yes—Max 1	Storage Slot	x8	No	x4 int x2 int	0, 1	No
6Gbps SAS HBA	6Gbps SAS HBA	LTO5, legacy SAS Tape	Yes—Max 2	PCIe slot	x8	Yes	x4 ext x4 ext	—	No
ICH10 SATA	On Planar via chipset	Internal slim-line SATA Optical (No HDD)	Yes—1 port for Optical	—	—	—	x1 int	—	—
LSI 2032 SCSI	LSI 2032 Adapter	External SCSI Tape/Legacy External Storage	Yes—Max 2	PCIe slot	x8	Yes	SCSI ext	—	—

A maximum of two external storage controllers (Dell PERC and SAS cards) are allowed in the system in addition to the integrated storage controller.

## 12.7 LED Indicators

Each disk drive carrier has two LED indicators visible from the front of the system. One is a green LED for disk activity and the other is a bicolor (Green/Amber) LED for status information. The activity LED is driven by the disk drive during normal operation. The bicolor LED is controlled by the SEP device on the backplane. Both LEDs are used to indicate certain conditions under direction of a storage controller.

## 12.8 Optical Drives

Optical drives are optional in all R810 systems and connect to the planar via the SATA interface. DVD-ROM and DVD+RW internal slim-line drives are available on R810. PATA (IDE) optical drives are not supported.

If an optical drive is not ordered with the system, a blank is installed in its place.

## 12.9 External Storage Support and Tape Drives

See the Data Storage and Backup chapter of the *PowerEdge R810 Hardware Owner's Manual* on [Support.Dell.com/Manuals](http://Support.Dell.com/Manuals) for information about external storage and tape drives available.

## 13 Video

The Dell™ PowerEdge™ R810 Integrated Dell Remote Access Controller 6 (iDRAC6) incorporates an integrated video subsystem, connected to the 32-bit PCI interface of the ICH10. This logic is based on the Matrox® G200. The device only supports 2D graphics.

The video device outputs are multiplexed between the front and rear video ports. If a monitor is connected to the front video connector, it will take precedence over the rear connection, thereby removing the display from the rear connection.

The integrated video core shares its video memory with the iDRAC6 128 MB DDR2 application space memory. This memory is also used for the KVM buffer.

The R810 system supports the 2D graphics video modes shown in Table 16.

**Table 16. Supported Video Modes**

Resolution	Refresh Rate (Hz)	Color Depth (bit)
640 x 480	60, 72, 75, 85	8, 16, 32
800 x 600	56, 60, 72, 75, 85	8, 16, 32
1024 x 768	60, 72, 75, 85	8, 16, 32
1152 x 864	75	8, 16, 32
1280 x 1024	60, 75, 85	8, 16
1280 x 1024	60	32

## 14 Rack Information

### 14.1 Overview

The ReadyRails™ sliding rail system for the Dell™ PowerEdge™ R810 provides toolless support for racks with square or unthreaded round mounting holes including all generations of Dell racks. The optional cable management arm (CMA) can be mounted on either the left or right side of the sliding rails without the use of tools for fast and easy deployment.

- The R810 is not compatible with any other Dell rails including previous generation rails, but it does use the same rails as the R815 and R910.
- The R810 supports sliding rails only. Static rails are not supported.
- Threaded-hole racks require Dell's fixed shelf or adapter brackets available from RackSolutions.
- The CMA is not supported on racks that are less than 1 m in depth including Dell's 4200 and 2400 racks.

### 14.2 Rails

The ReadyRails sliding rails for the R810 support toolless mounting in 19 inch-wide, EIA-310-E compliant square-hole and unthreaded round-hole racks and are available with or without the optional cable management arm (CMA).

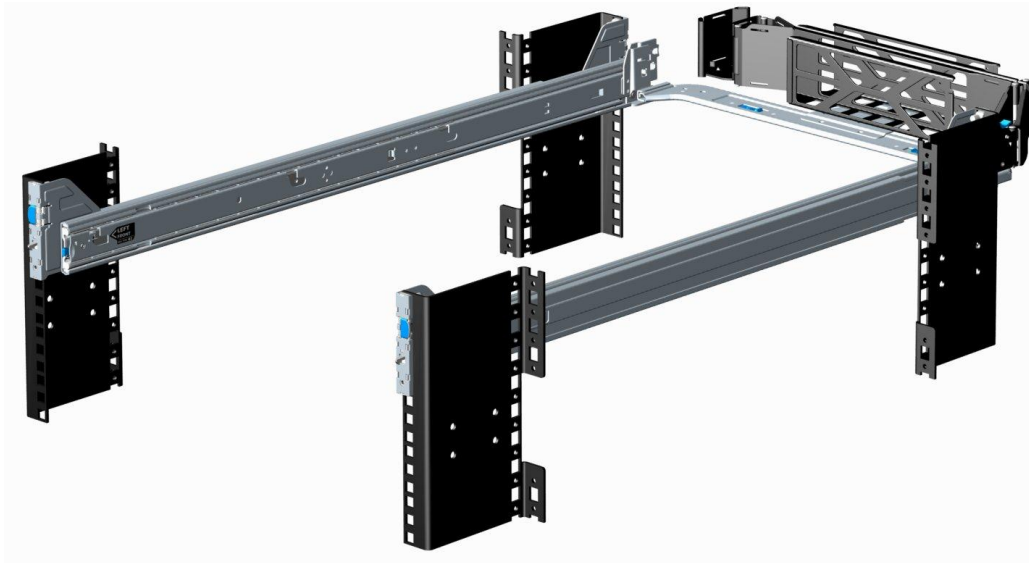

Figure 13. ReadyRails Sliding Rails with Optional CMA

The R810 rails do not support mounting in threaded hole or two-post racks.



**Table 17. Supported Racks**

Rail Identifier	Mounting Interface	Rail Type	Rack Types Supported				
			4-Post			2-Post	
			Square	Round	Thread	Flush	Center
B2	ReadyRails™	Sliding	✓	✓	X	X	X

\*Adapter brackets are available from RackSolutions that allow the R810 sliding rails to mount in threaded racks. The only option available for two-post racks is to mount the system on a fixed shelf.

Other factors to consider when deploying the R810 include the spacing between the front and rear mounting flanges of the rack, the type and location of any equipment mounted in the back of the rack such as power distribution units (PDUs), and the overall depth of the rack. For example, use of the CMA requires racks that are a minimum of 1m in depth with the PDUs or other rack accessories positioned on the sides or rear of the rack away from the CMA.

**Table 18. Rail Adjustability Ranges and Depth**

Rail Adjustability Range (mm)						Rail Depth (mm)	
Square		Round		Threaded		without CMA	with CMA
Min	Max	Min	Max	Min	Max		
686	883	672	876	—	—	755	883

The min-max values listed above represent the allowable distance between the front and rear mounting flanges in the rack. Rail depth without the CMA represents the minimum depth of the rail with the outer CMA brackets removed (as measured from the front mounting flanges of the rack).

### 14.3 Cable Management Arm

The optional cable management arm (CMA) for the R810 organizes and secures the cords and cables exiting the back of the server and unfolds to allow the server to extend out of the rack without having to detach the cables. Some key features of the R810 CMA include:

- Large U-shaped baskets to support dense cable loads
- Open vent pattern for optimal airflow
- Fully reversible (can be mounted on either side) with no conversion required
- Utilizes hook-and-loop straps rather than plastic tie wraps to eliminate the risk of cable damage during cycling
- Includes a low-profile fixed tray to both support and retain the CMA in its fully closed position
- Both the CMA and the tray mount without the use of tools via simple and intuitive snap-in designs

### 14.4 Rack View

The R810 ReadyRails sliding rails are a “drop-in” design, meaning that the system is installed vertically into the rails by inserting the shoulder nuts on the sides of the system into the J-slots in the inner rail members with the rails in the fully extended position.



Figure 14. R810 Mounted in the B2 Sliding Rails

The R810 CMA can be mounted to either side of the rails without the use of tools or the need for conversion, but it is recommended that it be mounted on the side opposite the power supplies to allow easier access to the power supplies for service or replacement.



Figure 15. CMA Mounted on the Side Opposite the Power Supplies (Recommended)

## 15 Operating Systems

For detailed information, see the following:

- [Operating System Support Matrix for Dell PowerEdge Systems](#) on Dell.com
- *Dell PowerEdge R810 Systems Getting Started Guide* on [Support.Dell.com/Manuals](http://Support.Dell.com/Manuals)

## 16 Systems Management

### 16.1 Overview

Dell delivers open, comprehensive, and integrated solutions that help you reduce the complexity of managing disparate IT assets. Combining Dell PowerEdge Servers with a wide selection of Dell developed systems management solutions gives you choice and flexibility, so you can simplify and save in IT environments of any size. To help you meet your server management demands, Dell offers Dell OpenManage™ systems management solutions for:

- Deployment of one or many servers from a single console
- Monitoring of server and storage health and maintenance
- Update of system, operating system, and application software

Dell offers IT management solutions for organizations of all sizes—priced and sized appropriately and supported comprehensively.

### 16.2 Server Management

A Dell Systems Management and Documentation DVD and a Dell Management Console DVD are included with the product. ISO images are also available. A brief description of available content:

- Dell Systems Build and Update Utility (SBUU): Dell Systems Build and Update Utility assists in OS install and pre-OS hardware configuration and updates.
- Server Update Utility (SUU): This DVD has an inventory tool for managing updates to firmware, BIOS, and drivers for either Linux® or Microsoft® Windows® varieties.
- OpenManage Server Administrator (OMSA): The OpenManage Server Administrator tool provides a comprehensive, one-to-one (one console to one server) systems management solution, designed for system administrators to manage systems locally and remotely over a network. OMSA allows system administrators to focus on managing their entire network.
- Management Console: Dell IT Assistant (ITA) is also included, as well as tools to allow access to our remote management products. These tools are Remote Access Service for iDRAC, and the Baseboard Management Controller (BMC) Utility.
- Active Directory Snap-in Utility: The Active Directory Snap-in Utility provides an extension snap-in to the Microsoft® Active Directory. This allows you to manage Dell specific Active Directory objects. The Dell-specific schema class definitions and their installation are also included on the DVD.
- Dell Systems Service Diagnostics Tools: Dell Systems Service and Diagnostics tools deliver the latest Dell optimized drivers, utilities, and operating system-based diagnostics that you can use to update your system.
- eDocs: The section includes PDF files for PowerEdge systems, storage peripherals, and OpenManage software.
- Dell Management Console (DMC): The Dell Management Console is a systems management console that enables systems administrators to discover and inventory devices on your network. It provides functions such as health and performance monitoring of networked devices, and patch management capabilities for Dell systems. DMC differs from the IT Assistant management console (described above) in that with DMC, value-add plug-ins that enable advanced functionality can be purchased and added to the base DMC product.

### 16.3 Embedded Server Management

The Dell™ PowerEdge™ R810 implements circuitry for the next generation of Embedded Server Management. It is Intelligent Platform Management Interface (IPMI) v2.0 compliant. The iDRAC

Dell

(Integrated Dell Remote Access Controller) is responsible for acting as an interface between the host system and its management software and the peripheral devices.

iDRAC6 provides features for managing the server remotely or in data center lights-out environments. Advanced iDRAC features require the installation of the optional iDRAC6 Enterprise card.

## 16.4 Dell Lifecycle Controller and Unified Server Configurator

Embedded management is comprised of interdependent pieces:

- Dell Lifecycle Controller
- Unified Server Configurator
- iDRAC6

Dell Lifecycle Controller powers the embedded management features. It is integrated and tamper-proof storage for system-management tools and enablement utilities (firmware, drivers, etc.). Lifecycle Controller enables pre-OS server deployment, OS installation, platform updates, platform configuration, and diagnostics capabilities.

Dell Unified Server Configurator (USC) is a graphical user interface (GUI) that aids in local server provisioning in a pre-OS environment. To access the Unified Server Configurator, press the <F10> key within 10 seconds of the Dell logo's appearance during the system boot process. Current functionality enabled by the Unified Server Configurator includes those shown in Table 19.

**Table 19. Unified Server Configurator Features and Description**

Feature	Description
Faster O/S Installation	Drivers and the installation utility are embedded on system, so no need to scour Dell.com
Faster System Updates	Integration with Dell support automatically directed to latest versions of the Unified Server Configurator, iDRAC, RAID, BIOS, NIC, and Power Supply
Update Rollback	Ability to recover to previous "known good state" for all updatable components
More Comprehensive Diagnostics	Diagnostic utilities are embedded on system
Simplified Hardware Configuration	Detects RAID controller and allows user to configure virtual disk and choose virtual disk as boot device, eliminating the need to launch a separate utility. Also provides configuration for iDRAC, BIOS, and NIC/LOM.

## 16.5 Integrated Dell Remote Access Controller

The integrated Dell Remote Access Controller (iDRAC6) provides IT Administrators comprehensive yet straightforward management of remote servers, by delivering "as if you are there" presence and control. iDRAC6 helps users to save time and money by eliminating travel to the remote server(s), whether that server is located in a different room, a different building, a different city, or in a different country.

iDRAC6 is a purchasable option and is available as three offerings: iDRAC6 Express, iDRAC6 Enterprise, and Virtual Flash (vFlash) media:

- iDRAC6 Express is most appropriate for SMB customers with limited remote management needs.
- iDRAC6 Enterprise is appropriate for large data center customers with distributed servers.

Dell

- iDRAC6 with vFlash media is provided for large enterprise customers with requirements for system management automation.

## 16.6 iDRAC6 Express

The iDRAC6 Express is standard on the PowerEdge R810. In addition to providing a Lifecycle Controller, the iDRAC6 Express offers the following key features:

- Graphical web interface
- Standard-based interfaces
- Server Sensor monitoring and fault alerting
- Secure operation of remote access functions including authentication, authorization, and encryption
- Power control and management with the ability to limit server power consumption and remotely control server power states
- Advanced troubleshooting capabilities

For more information on iDRAC6 Express features see Table 20.

## 16.7 iDRAC6 Enterprise

The optional iDRAC6 Enterprise card provides access to advanced iDRAC6 features. The iDRAC6 Enterprise connects directly to the R810 planar and is mounted parallel to the planar with stand-offs.

Key features for the iDRAC6 Enterprise include:

- Scripting capability with Dell's racadm command line
- Remote video, keyboard, and mouse control with Virtual Console
- Remote media access with Virtual Media
- Dedicated network interface

## 16.8 iDRAC6 Enterprise with Virtual Flash (vFlash) Media

The iDRAC6 Enterprise can be upgraded by adding the vFlash Media card. This is an 8GB Dell branded SD card that enables a persistent 256 MB virtual flash partition. The vFlash Media delivers the following key features:

- Support for 8 GB SD storage media
- Can be used as a repository for a pre-OS image, eliminating the need to maintain a network infrastructure for OS deployment
- Can also be used for permanent diagnostics image for use after system failures, or permanent failsafe image for periodic configuration changes

A more detailed feature list for iDRAC6 Express, iDRAC6 Enterprise, and vFlash media is shown in Table 20.

Table 20. Features List for Base Management Functionality, iDRAC6, and vFlash Media

Feature	Base Management Functionality	iDRAC6 Express	iDRAC6 Enterprise	vFlash Media
<b>Interface and Standards Support</b>				
IPMI 2.0	✓	✓	✓	✓
Web-based GUI		✓	✓	✓
SNMP		✓	✓	✓
WSMAN		✓	✓	✓
SMASH-CLP		✓	✓	✓
Racadm command-line			✓	✓
<b>Conductivity</b>				
Shared/Failover Network Modes	✓	✓	✓	✓
IPv4	✓	✓	✓	✓
VLAN Tagging	✓	✓	✓	✓
IPv6		✓	✓	✓
Dynamic DNS		✓	✓	✓
Dedicated NIC			✓	✓
<b>Security and Authentication</b>				
Role-based Authority	✓	✓	✓	✓
Local Users	✓	✓	✓	✓
Active Directory		✓	✓	✓
SSL Encryption		✓	✓	✓
<b>Remote Management and Remediation</b>				
Remote Firmware Update	✓	✓	✓	✓
Server power control	✓	✓	✓	✓
Serial-over-LAN (with proxy)	✓	✓	✓	✓
Serial-over-LAN (no proxy)		✓	✓	✓
Power capping		✓	✓	✓
Last crash screen capture		✓	✓	✓
Boot capture		✓	✓	✓
Serial-over-LAN		✓	✓	✓

Feature	Base Management Functionality	iDRAC6 Express	iDRAC6 Enterprise	vFlash Media
Virtual media			✓	✓
Virtual console			✓	✓
Virtual console sharing			✓	✓
Virtual flash				✓
<b>Monitoring</b>				
Sensor Monitoring and Alerting	✓	✓	✓	✓
Real-time Power Monitoring		✓	✓	✓
Real-time Power Graphing		✓	✓	✓
Historical Power Counters		✓	✓	✓
<b>Logging Features</b>				
System Event Log	✓	✓	✓	✓
RAC Log		✓	✓	✓
Trace Log			✓	✓



## 17 Peripherals

### 17.1 USB Peripherals

The Dell™ PowerEdge™ R810 supports the following USB devices:

- DVD (bootable; requires two USB ports)
- USB Key (bootable)
- Keyboard (only one USB keyboard is supported)
- Mouse (only one USB mouse is supported)

### 17.2 External Storage

See [Dell.com/Storage](http://Dell.com/Storage) for information on external storage.

## Appendix A. Statement of Volatility

The Dell™ PowerEdge™ R810 contains both volatile and non-volatile (NV) components. Volatile components lose their data immediately upon removal of power from the component. Non-volatile components continue to retain their data even after the power has been removed from the component. Components chosen as user-definable configuration options (those not soldered to the motherboard) are not included in the Statement of Volatility. Configuration option information (pertinent to options such as microprocessors, system memory, remote access controllers, and storage controllers) is available by component separately. The following NV components are present in the PowerEdge R810 server.

**Table 21. System Volatility**

Server BIOS Memory	
Size	32 Mbit
Type [Flash PROM, EEPROM]	Flash EEPROM
Can user programs or operating system write data to it during normal operation?	No
Purpose	Boot Code and Configuration Information
How is data input to this memory?	Loading flash memory requires a vendor-provided firmware file and loader program which is executed by booting up the system from a USB key (or floppy). In addition, an OS-based update package executable containing the firmware file can be run. A system loaded with arbitrary data in BIOS FLASH memory will not operate.
How is this memory write protected?	Software write protected
Server CMOS (Complementary Metal-Oxide Semiconductor) Memory	
Size:	512 Bytes
Type: [Flash PROM, EEPROM]:	Battery-backed NVRAM
Can user programs or operating system write data to it during normal operation?	No
Purpose? [boot code]	RTC and Configuration settings
How is data input to this memory?	BIOS default settings, which can be altered by F2 Setup Menu during POST
How is this memory write protected?	N/A
Remarks	Jumper on motherboard can be used to clear to factory default settings
Ethernet Controller Configuration Data	
Size:	8 Mb
Type: [Flash PROM, EEPROM]:	Flash
Can user programs or operating system write data to it during normal operation?	No
Purpose? [boot code]	Controller Firmware & configuration data

How is data input to this memory?	Loading flash memory requires a vendor-provided firmware file and loader program which is executed by booting up the system from a floppy or OS-based executable containing the firmware file and the loader. System loaded with arbitrary data in firmware memory would not operate.
How is this memory write protected?	Software write protected
<b>Server System Event Log Memory/FRU</b>	
Size:	4 Kb
Type: [Flash PROM, EEPROM]:	SERIAL EEPROM
Can user programs or operating system write data to it during normal operation?	No
Purpose? [boot code]	Store System Events
How is data input to this memory?	BMC controller write
How is this memory write protected?	Not write protected
<b>Power Supply Firmware/FRU</b>	
Size:	LiteOn: IC050: MC9S08QG4—4 K FLASH, 256 bytes RAM IC900: 32GA002—32KFlash 8K RAM Emerson: U4: ST7LITE49K2—8K Flash 384 bytes RAM U9: ST72F345C4T6—16K Flash 1024 bytes RAM
Type: [Flash PROM, EEPROM]:	FLASH
Can user programs or operating system write data to it during normal operation?	No
Purpose? [boot code]	Control firmware for the power supply microcontroller
How is data input to this memory?	Programmed by the power supply manufacturer. If necessary, Dell Update Package can be run to update firmware
How is this memory write protected?	Not write protected
<b>PCI-e Switch EEPROM</b>	
Size:	128 KB Bytes
Type: [Flash PROM, EEPROM]:	SERIAL EEPROM
Can user programs or operating system write data to it during normal operation?	No
Purpose? [boot code]	Store PCI-e Switch configuration information
How is data input to this memory?	Pre-programmed at manufacturing before assembled to board.
How is this memory write protected?	Not write protected
<b>Trusted Platform Module (TPM)</b>	
Size:	128 Bytes

Type: [Flash PROM, EEPROM]:	EEPROM
Can user programs or operating system write data to it during normal operation?	No
Purpose? [boot code]	Store firmware for TPM functionality
How is data input to this memory?	Loading flash memory requires a vendor provided firmware file and loader program. System loaded with arbitrary data in firmware memory would not operate.
How is this memory write protected?	Software write protected
<b>Backplane Firmware and FRU</b>	
Size:	32 KB
Type: [Flash PROM, EEPROM]:	Flash
Can user programs or operating system write data to it during normal operation?	No
Purpose? [boot code]	Backplane Firmware and FRU data storage
How is data input to this memory?	Loading flash memory requires a vendor-provided firmware file and loader program which is executed by booting up the system from a floppy or OS-based executable containing the firmware file and the loader. System loaded with arbitrary data in firmware memory would not operate.
How is this memory write protected?	Software write protected
<b>Embedded Bootable Memory Device</b>	
Size:	1 GB
Type: [Flash PROM, EEPROM]:	SD card
Can user programs or operating system write data to it during normal operation?	Yes
Purpose? [boot code]	Optional embedded boot device
How is data input to this memory?	Factory installed or via USB bus
How is this memory write protected?	Not write protected

<b>Server BMC (Baseboard Management Controller) Firmware Flash Memory</b>	
Size:	16 Mb Flash
Type: [Flash PROM, EEPROM]:	Flash PROM
Can user programs or operating system write data to it during normal operation?	No
Purpose? [boot code]	Stores the BMC Firmware
How is data input to this memory?	Loading flash memory requires a vendor provided firmware file and loader program which is executed by booting up the system from a floppy or OS-based executable containing the firmware file and the loader. System loaded with arbitrary data in firmware memory will not operate.
How is this memory write protected?	Software write protected
<b>IDSDM MCU</b>	
Size:	256 KBytes
Type: [Flash PROM, EEPROM]:	EEPROM
Can user programs or operating system write data to it during normal operation?	No
Purpose? [boot code]	Store firmware for IDS DM functionality
How is data input to this memory?	Loading flash memory requires a vendor-provided firmware file and loader program. IDS DM module loaded with arbitrary data in firmware memory will not operate.
How is this memory write protected?	Software write protected
<b>IDSDM Write Journal Flash</b>	
Size:	8 MBytes
Type: [Flash PROM, EEPROM]:	EEPROM
Can user programs or operating system write data to it during normal operation?	No
Purpose? [boot code]	Store write journal for shutdown recovery
How is data input to this memory?	IDSDM Microcontroller writes to and reads from this memory through SPI interface during operation
How is this memory write protected?	N/A

To obtain optional component information, please refer to the Dell Statement of Volatility for the individual components. Please direct any questions to your Dell Marketing contact.

## Appendix B. Certifications

### B 1. Regulatory Certifications

Regulatory compliance certificates can be located at the following sites:

- <http://ausreactorprd01/reactor/xCertSearch.asp>
- [http://www.dell.com/content/topics/global.aspx/about\\_dell/values/regulatory\\_compliance/dec\\_conform?c=us&l=en&s=corp](http://www.dell.com/content/topics/global.aspx/about_dell/values/regulatory_compliance/dec_conform?c=us&l=en&s=corp)

### B 2. Product Safety Certifications

The product has been certified and bears the Mark, as applicable, of the Product Safety authorities as indicated in Table 22.

**Table 22. Product Safety Certifications**

Country/Region	Authority or Mark
Argentina	IRAM
Belarus	BELLIS
Canada	SCC
China	CNCA or CCC
Croatia	KONCAR
European Union	CE
Germany	TUV
IECEE	IECEE CB
Israel	SII
Kazakhstan	OTAN - CKT
Kenya	KEBS
Kuwait	KUCAS
Mexico	NYCE or NOM
Moldova	INSM
Nigeria	SONCAP
Norway	NEMKO
Russia	GOST
Saudi Arabia	KSA ICCP
South Africa	NRCS
Taiwan	BSMI
Ukraine	UKRTEST or UKRSERTCOMPUTER
United States	NRTL
Uzbekistan	STZ

### B 3. Electromagnetic Compatibility

The product has been certified and bears the Mark, as applicable, of the EMC authorities as indicated in Table 23.

**Table 23. Electromagnetic Compatibility Certifications**

Country/Region	Authority or Mark	Class
Australia/New Zealand	ACMA or C-Tick	Class A
Belarus	BELLIS	Class A
Bosnia, Herzegovina, Montenegro, Serbia	KVALITET	Class A
Canada	ICES	Class A
China	CNCA or CCC	Class A
Croatia	KONCAR	Class A
European Union	CE	Class A
Israel	SII	Class A
Japan	VCCI	Class A
Kazakhstan	OTAN - CKT	Class A
Moldova	INSM	Class A
Norway	NEMKO	Class A
Russia	GOST	Class A
South Africa	SABS	Class A
South Korea	KCC	Class A
Taiwan	BSMI	Class A
Ukraine	UKRTEST or UKRSERTCOMPUTER	Class A
United States	FCC	Class A
Uzbekistan	STZ	Class A
Vietnam	ICT	Class A

### B 4. Ergonomics, Acoustics and Hygienics

The product has been certified and bears the Mark, as applicable, of the Ergonomics, Acoustics and Hygienics authorities as indicated in Table 24.

**Table 24. Ergonomics, Acoustics and Hygienics**

Country/Region	Authority or Mark
Belarus	BELLIS
Germany	GS
Russia	GOST

## Appendix C. Industry Standards

The Dell™ PowerEdge™ R810 system conforms to the industry standards detailed in Table 25.

**Table 25. Industry Standards**

Standard	URL for Information and Specifications
ACPI Advance Configuration and Power Interface Specification, v2.0c	<a href="http://www.acpi.info/">http://www.acpi.info/</a>
Energy Star EPA Version 1.0 of the Computer Server specification	<a href="http://www.energystar.gov/index.cfm?c=archives.enterprise_servers">http://www.energystar.gov/index.cfm?c=archives.enterprise_servers</a>
Ethernet IEEE 802.3-2005	<a href="http://standards.ieee.org/getieee802/802.3.html">http://standards.ieee.org/getieee802/802.3.html</a>
IPMI Intelligent Platform Management Interface, v2.0	<a href="http://www.intel.com/design/servers/ipmi/">http://www.intel.com/design/servers/ipmi/</a>
DDR3 Memory DDR3 SDRAM Specification, Rev. 3A	<a href="http://www.jedec.org/download/search/JESD79-3A.pdf">http://www.jedec.org/download/search/JESD79-3A.pdf</a>
LPC Low Pin Count Interface Specification, Rev. 1.1	<a href="http://developer.AMD.com/design/chipsets/industry/lpc.htm">http://developer.AMD.com/design/chipsets/industry/lpc.htm</a>
PCI Express PCI Express Base Specification Rev. 2.0	<a href="http://www.pcisig.com/specifications/pciexpress/">http://www.pcisig.com/specifications/pciexpress/</a>
PMBus Power System Management Protocol Specification, v1.1	<a href="http://pmbus.info/specs.html">http://pmbus.info/specs.html</a>
SAS Serial Attached SCSI, v1.1	<a href="http://www.t10.org/cgi-bin/ac.pl?t=f&amp;f=sas1r10.pdf">http://www.t10.org/cgi-bin/ac.pl?t=f&amp;f=sas1r10.pdf</a>
SATA Serial ATA Rev. 2.6; SATA II, Extensions to SATA 1.0a, Rev. 1.2	<a href="http://sata-io.org/">http://sata-io.org/</a>
SMBIOS System Management BIOS Reference Specification, v2.6	<a href="http://www.dmtf.org/standards/smbios/">http://www.dmtf.org/standards/smbios/</a>
TPM Trusted Platform Module Specification, v1.2	<a href="http://www.trustedcomputinggroup.org/resources/tpm_main_specification">http://www.trustedcomputinggroup.org/resources/tpm_main_specification</a>
UEFI Unified Extensible Firmware Interface Specification, v2.1	<a href="http://www.uefi.org/specs/">http://www.uefi.org/specs/</a>



Dell

Standard	URL for Information and Specifications
USB Universal Serial Bus Specification, Rev. 2.0	<a href="http://www.usb.org/developers/docs/">http://www.usb.org/developers/docs/</a>
<b>Windows Logo</b> Windows Logo Program System and Device Requirements, v3.10	<a href="http://www.microsoft.com/whdc/winlogo/hwrequirements.msp">http://www.microsoft.com/whdc/winlogo/hwrequirements.msp</a>