

## IBM System x3630 M4

### IBM Redbooks Product Guide

The IBM® System x3630 M4 server offers a cost-effective high-capacity storage solution with exceptional energy-smart design, leadership virtualization, and powerful systems management. It supports up to two eight-core Intel Xeon processors and high-density memory designs with twelve DDR3 DIMM slots. This 2U server consolidates storage and server into one system, offers easy management, and saves floor space and power consumption, costing less money than traditional enterprise offerings. Designed with redundancy, flexible subsystems, and a wider range of configuration options, the x3630 M4 also offers an innovative Feature on Demand (FoD) design for an easier upgrade path.

*Suggested use:* Collaboration/email applications, light databases, virtualization/cloud, virtual desktops, web serving, and virtual storage.

The following figure shows the IBM System x3630 M4.



Figure 1. The IBM System x3630 M4

### Did you know

The IBM System x3630 M4 server is designed to provide exceptional value and flexibility to meet general business or storage-intensive requirements with up to 42 TB of storage space in a dense 2U form factor and 80 PLUS Platinum certified power supplies. The flexible onboard Ethernet solution provides two standard integrated Gigabit Ethernet ports and two additional integrated Gigabit Ethernet ports with an optional software FoD upgrade without needing to buy additional hardware. Comprehensive systems management tools with the next-generation Integrated Management Module II (IMM2) make it easy to deploy, integrate, service, and manage.

## Key features

Backed by the IBM legendary worldwide service and support, the x3630 M4 is developed, quality-tested, and certified by IBM, the leading vendor in technology patents for 17 years running. IBM System x® advancements in scalability, reliability, and performance can help your business innovate and thrive. With more flexible configuration options, energy-efficient components, and robust systems management tools, the x3630 M4 is an innovative design by IBM that can deliver business value over the long term.

### Scalability and performance

The x3630 M4 offers numerous features to boost performance, improve scalability, and reduce costs:

- The Intel Xeon processor E5-2400 product family improves productivity by offering affordable dual-socket system performance with eight-core processors with up to 2.3 GHz core speeds, up to 20 MB of L3 cache, and one QPI interconnect link of up to 8 GTps.
- Up to two processors, 16 cores, and 32 threads maximize the concurrent execution of multithreaded applications.
- Intelligent and adaptive system performance with Intel Turbo Boost Technology 2.0 allows processor cores to run at maximum speeds during peak workloads by temporarily going beyond processor thermal design power (TDP).
- Intel Hyper-Threading Technology boosts performance for multithreaded applications by enabling simultaneous multithreading within each processor core, up to two threads per core.
- Intel Virtualization Technology integrates hardware-level virtualization hooks that allow operating system vendors to better use the hardware for virtualization workloads.
- Intel Advanced Vector Extensions (AVX) improve floating point performance for compute-intensive technical and scientific applications.
- The 12 RDIMMs of 1600 MHz DDR3 ECC memory provide speed, high availability, and a memory capacity of up to 384 GB (running at 1066 MHz).
- The theoretical maximum memory bandwidth of the Intel Xeon processor E5-2400 product family is 38.4 GBps, which is 20% more than in the previous generation of Intel Xeon 5600 processors.
- The server offers up to four integrated Gigabit Ethernet ports with convenient Feature on Demand upgrade process that does not require the purchasing of an additional hardware.
- The server offers PCI Express 3.0 I/O expansion capabilities that improve the theoretical maximum bandwidth by almost 100% (8 GTps per link using 128b/130b encoding) compared to the previous generation of PCI Express 2.0 (5 GTps per link using 8b/10b encoding).
- With Intel Integrated I/O Technology, the PCI Express 3.0 controller is integrated into the Intel Xeon processor E5 family. This controller helps to reduce I/O latency and increase overall system performance.
- Up to fourteen 3.5-inch hot-swap drive bays provide maximum internal storage density of up to 42 TB in a 2U form factor.

### Availability and serviceability

The x3630 M4 provides many features to simplify serviceability and increase system uptime:

- The server offers Chipkill, memory mirroring, and memory rank sparing for redundancy in the event of a non-correctable memory failure to prevent an unplanned outage.
- Tool-less cover removal provides easy access to upgrades and serviceable parts, such as processor, memory, and adapter cards.

- The server offers simple-swap or hot-swap drives supporting affordable software RAID and advanced hardware RAID redundancy for data protection and greater system uptime.
- The server offers up to two redundant hot-swap power supplies and three dual-motor non-hot-swap redundant fans to provide cost-efficient availability for applications.
- The power source-independent light path diagnostics panel and optional individual light path LEDs quickly lead the technician to failed (or failing) components. This panel simplifies servicing, speeds up problem resolution, and helps improve system availability.
- Predictive Failure Analysis (PFA) detects when system components (processors, memory, hard disk drives, fans, and power supplies) operate outside of standard thresholds and generates proactive alerts in advance of a possible failure, therefore increasing uptime.
- The built-in Integrated Management Module II (IMM2) continuously monitors system parameters, triggers alerts, and performs recovery actions in case of failure, to minimize downtime.
- Built-in diagnostics using Dynamic Systems Analysis (DSA) Preboot speeds up troubleshooting tasks to reduce service time.
- Three-year customer replaceable unit and on-site limited warranty, next business day 9x5. Optional service upgrades available.

### **Manageability and security**

Powerful systems management features simplify local and remote management of the x3630 M4:

- The server includes an Integrated Management Module II (IMM2) to monitor server availability and perform remote management.
- An integrated industry-standard Unified Extensible Firmware Interface (UEFI) enables improved setup, configuration, and updates, and simplifies error handling.
- Integrated Trusted Platform Module (TPM) V1.2 support enables advanced cryptographic functionality, such as digital signatures and remote attestation.
- IBM Systems Director is included for proactive systems management. It offers comprehensive systems management tools that help increase uptime, reduce costs, and improve productivity through advanced server management capabilities.
- Industry-standard AES NI support provides faster and stronger encryption.
- Intel Execute Disable Bit functionality can help prevent certain classes of malicious buffer overflow attacks when combined with a supporting operating system.
- Intel Trusted Execution Technology provides enhanced security through hardware-based resistance to malicious software attacks, allowing an application to run in its own isolated space protected from all other software running on a system.

### **Energy efficiency**

The x3630 M4 offers the following energy-efficiency features to save energy, reduce operational costs, increase energy availability, and contribute to a green environment:

- Energy-efficient planar components help lower operational costs.
- 80 PLUS Platinum certified power supplies enable greater energy savings while providing flexibility to meet your business needs.
- The Intel Xeon processor E5-2400 product family offers better performance over the previous generation, while fitting into the same TDP limits.

- Intel Intelligent Power Capability powers individual processor elements on and off as needed, to reduce power draw.
- Low-voltage Intel Xeon processors draw less energy to satisfy the demands of power and thermally constrained data centers and telecommunication environments.
- Low-voltage 1.35 V DDR3 memory RDIMMs consume 19% less energy compared to 1.5 V DDR3 RDIMMs.
- The server uses hexagonal ventilation holes, a part of IBM Calibrated Vected Cooling™ technology. Hexagonal holes can be grouped more densely than round holes, providing more efficient airflow through the system.
- IBM Systems Director Active Energy Manager™ provides advanced data center power notification and management to help achieve lower heat output and reduced cooling needs.

## Locations of key components and connectors

The following figure shows the front of the server with eight 3.5-inch drive bays.

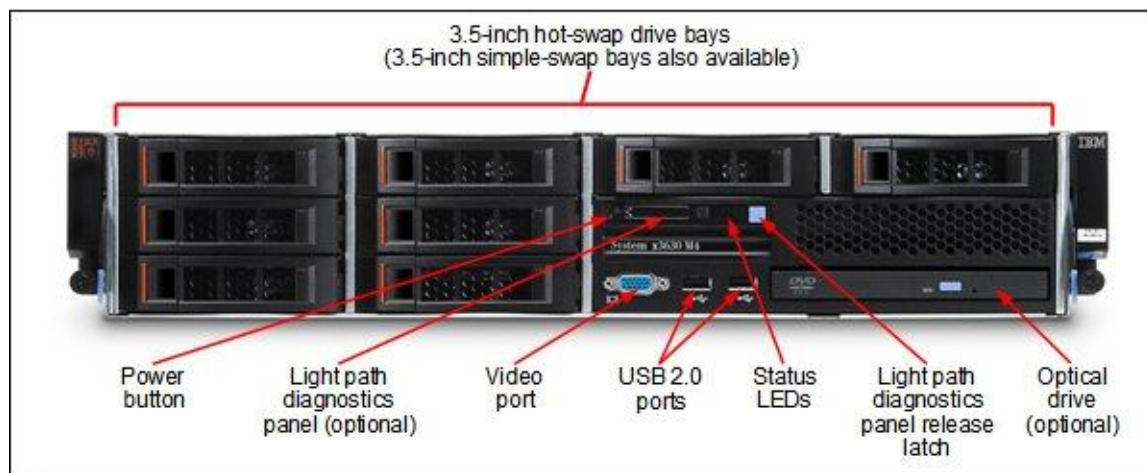

Figure 2. Front view of the IBM System x3630 M4 with eight drive bays

The following figure shows the front of the server with twelve 3.5-inch drive bays.

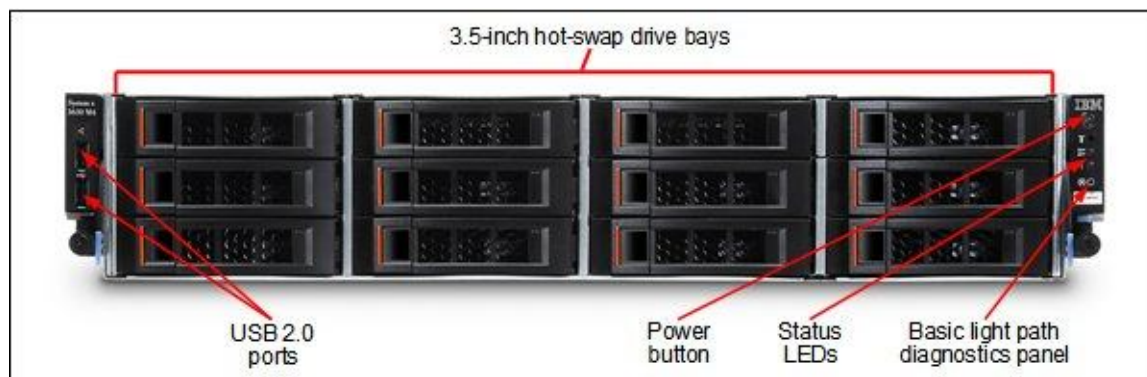

Figure 3. Front view of the IBM System x3630 M4 with twelve drive bays

The following figure shows the rear of the server without the optional rear HDD cage upgrade.

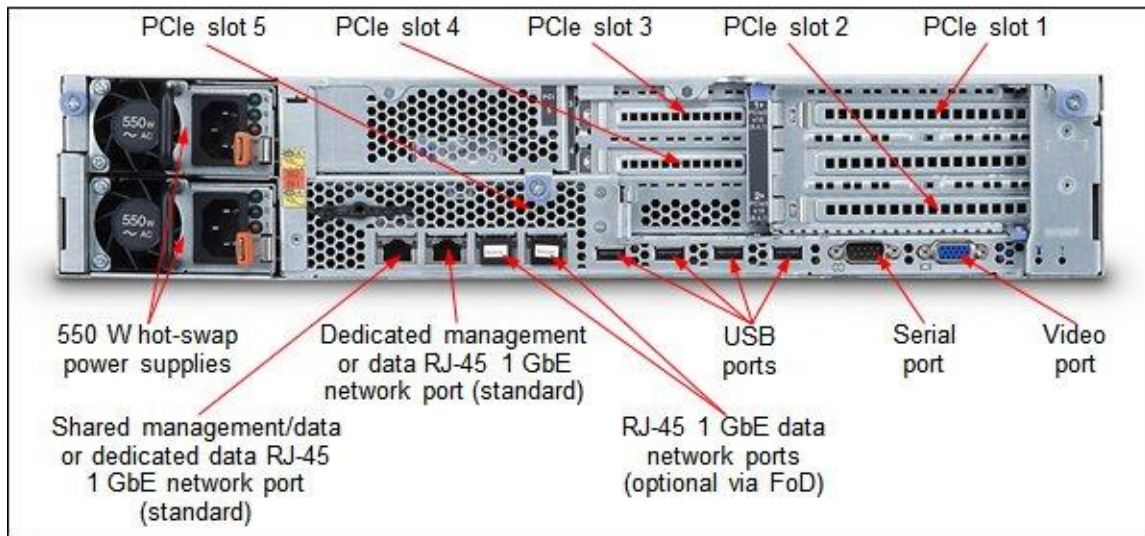

Figure 4. Rear view of the IBM System x3630 M4 without the rear HDD cage

The following shows the rear of the server with the optional rear HDD cage upgrade.

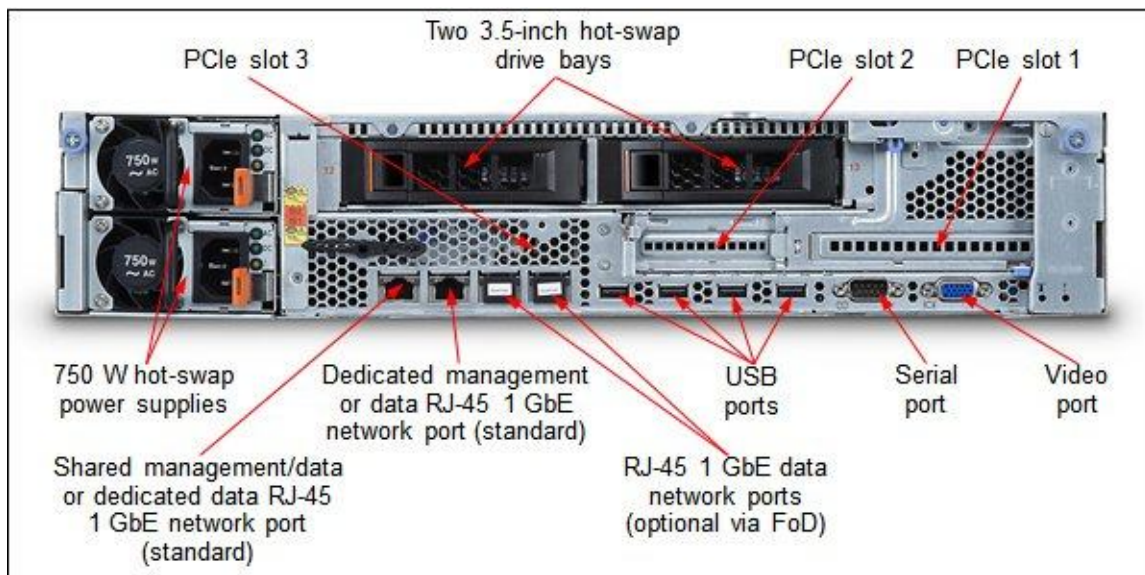

Figure 5. Rear view of the IBM System x3630 M4 with the rear HDD cage



The following figure shows the locations of key components inside the server.

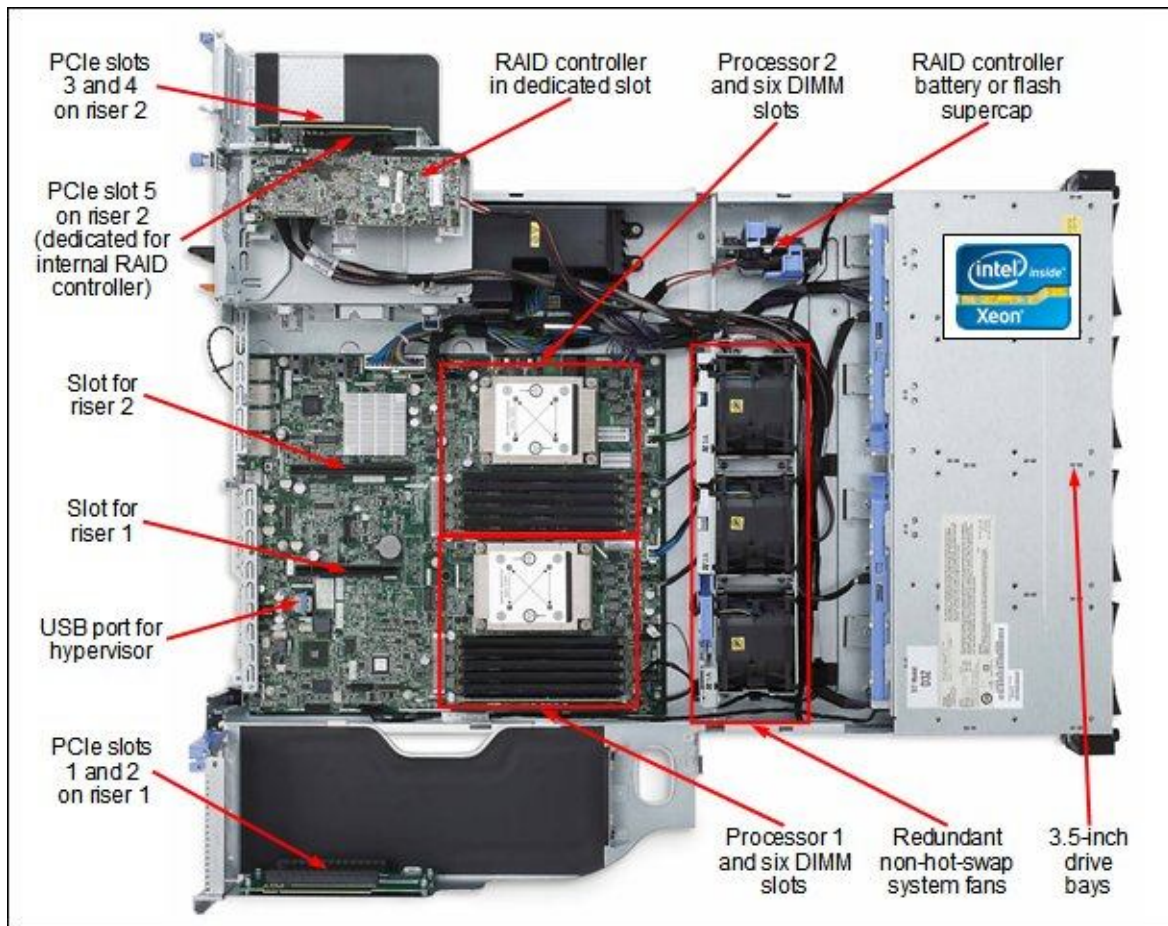

Figure 6. Inside view of the IBM System x3630 M4

## Standard specifications

The following table lists the standard specifications.

Table 1. Standard specifications (part 1)

Components	Specification
Form factor	2U rack.
Processor	Up to two Intel Xeon processor E5-2400 product family processors with eight cores (up to 2.3 GHz), six cores (up to 2.4 GHz) or four cores (up to 2.2 GHz), one QPI link up to 8.0 GTps, up to 1600 MHz memory speed, up to 20 MB L3 cache; or one Intel Xeon processor E5-1400 product family processor with four cores up to 2.8 GHz, 10 MB L3 cache, and 1333 MHz memory speed (CTO only); or one Intel Pentium processor 1400 product family processor with two cores up to 2.8 GHz, 5 MB L3 cache, and 1066 MHz memory speed (CTO only).
Chipset	Intel C600 series.
Memory	Up to 12 DIMM sockets (six DIMMs per processor). LRDIMMs, RDIMMs, and UDIMMs are supported, but memory types cannot be intermixed. DIMM speeds are up to 1600 MHz.
Memory maximums	With LRDIMMs: Up to 384 GB with 12x 32 GB RDIMMs and two processors With RDIMMs: Up to 192 GB with 12x 16 GB RDIMMs and two processors With UDIMMs: Up to 48 GB with 12x 4 GB UDIMMs and two processors
Memory protection	ECC, Chipkill, memory mirroring, and memory rank sparing.
Disk drive bays	Up to eight 3.5-inch SATA simple-swap drive bays, up to eight 3.5-inch SAS/SATA hot-swap drive bays, or up to fourteen 3.5-inch SAS/SATA hot-swap drive bays.
Maximum internal storage	Up to 56 TB with 4 TB 3.5-inch NL SAS/SATA HS HDDs, up to 32 TB with 4 TB 3.5-inch SATA SS HDDs, or up to 7.2 TB with 512 GB 3.5-inch SATA HS SSDs. An intermix of SAS/SATA is supported.
RAID support	RAID 0 and 1 with C105. RAID 0, 1, and 10 with M1115 or M5110. Upgrades to RAID 5 and 50 are available for M1115. Upgrades to RAID 5 and 50 are available for M5110 (zero-cache; 512 MB battery-backed cache; 512 MB or 1 GB flash-backed cache). Upgrade to RAID 6 or 60 is available for M5110 with caches.
Optical drive bays	One, for models with up to eight 3.5-inch drive bays. Support for optional DVD-ROM or multiburner.
Tape drive bays	Optional, for models with up to eight 3.5-inch drive bays. Tape Enablement Kit is required to support the internal tape drive. Support for optional DDS5 or DDS6 USB tape drives is available.
Network interfaces	Up to four integrated Gigabit Ethernet 1000BASE-T RJ-45 ports (two ports enabled, and an additional two ports require the optional software FoD upgrade to enable them).
Ports	Two USB 2.0 and one DB-15 video (not available on storage-rich models) port on the front. Four USB 2.0, one DB-15 video, one DB-9 serial, and four RJ-45 GbE network ports on the rear. Two internal USB ports (one for embedded hypervisor, one for internal USB tape drive).
Cooling	IBM Calibrated Vectored Cooling with three redundant non-hot-swap fans; each fan has two motors.
Power supply	Up to two redundant hot-swap 550 W HE AC, 750 W HE AC, or 900 W HE AC power supplies (all AC power supplies are 80 PLUS Platinum certified), or up to two redundant hot-swap 750 W HE DC power supplies.
Hot-swap parts	Hard drives (hot-swap models), power supplies.

Table 1. Standard specifications (part 2)

Components	Specification
I/O expansion slots	<p>Up to five slots in models with up to 12 drive bays, depending on the riser cards installed. The slots are as follows:</p> <ul style="list-style-type: none"> <li>Slot 1: PCIe 3.0 x16 (x8-wired), optional PCIe 3.0 x16 (x16-wired); full-height, full-length</li> <li>Slot 2: PCIe 3.0 x16 (x8-wired); full-height, half-length (not present if optional x16-wired slot 1 riser is used)</li> <li>Slot 3: PCIe 3.0 x16 (x8-wired), optional PCIe 3.0 x16 (x16-wired); low-profile, half-length (the second processor is required to use this slot)</li> <li>Slot 4: PCIe 3.0 x16 (x8-wired); low-profile, half-length (not present if optional x16-wired slot 3 riser is used, the second processor is required to use this slot)</li> <li>Slot 5: PCIe 3.0 x8 (x4-wired); dedicated slot for ServeRAID adapter; standard on hardware RAID models, optional on software RAID models</li> </ul> <p>Up to three slots in models with 14 drive bays, depending on the riser cards installed. The slots are as follows:</p> <ul style="list-style-type: none"> <li>Slot 1: PCIe 3.0 x8 (x8-wired), optional PCIe 3.0 x16 (x16-wired); full-height, half-length</li> <li>Slot 2: PCIe 3.0 x8 (x8-wired); low-profile, half-length (not present if an optional x16-wired slot 1 riser is used)</li> <li>Slot 3: PCIe 3.0 x8 (x4-wired), optional PCIe 3.0 x8 (x8-wired); dedicated slot for ServeRAID adapter (x8-wired slot requires the second processor, x4-wired slot does not require the second processor)</li> </ul>
Systems management	UEFI, IBM Integrated Management Module II (IMM2), Predictive Failure Analysis, light path diagnostics (basic standard, advanced optional), Automatic Server Restart, IBM Systems Director and IBM Systems Director Active Energy Manager, and IBM ServerGuide. Optional IMM Advanced FoD Upgrade for remote presence (graphics, keyboard and mouse, and virtual media).
Security features	Power-on password, administrator's password, and Trusted Platform Module (TPM).
Video	Matrox G200eR2 with 16 MB memory integrated into the IMM2. Maximum resolution is 1600x1200 at 75 Hz with 16 M colors.
Operating systems supported	Microsoft Windows Server 2012, 2008 R2 and 2008 (x64), Red Hat Enterprise Linux 5 and 6, SUSE Linux Enterprise Server 10 and 11, VMware ESX 4.1 and VMware ESXi 4.1 embedded hypervisor, and VMware vSphere 5.
Limited warranty	Three-year customer-replaceable unit and on-site limited warranty with 9x5/NBD.
Service and support	Optional service upgrades (country-specific) are available through IBM ServicePac® offerings: 4-hour or 2-hour response time, 8 hours fix time, one-year or two-year warranty extension, remote technical support for IBM hardware and selected IBM and third-party (Microsoft, Linux, VMware) software.
Dimensions	Height: 86 mm (3.4 in.), width: 447 mm (17.6 in.), depth: 749 mm (29.5 in.)
Weight	Minimum configuration: 16.4 kg (36.2 lb), maximum: 28.2 kg (62.2 lb)

The x3630 M4 servers are shipped with the following items:

- Registration flyer
- Statement of Limited Warranty
- Important Notices
- Rack Installation Instructions
- Documentation CD containing *Installation and User's Guide*
- IBM Systems Director 6.3 Base for x86 DVD-ROM
- Rail kit (static rails, non-sliding; no cable management arm included)
- One 2.8m, 10A/100-250V, C13 to IEC 320-C14 rack power cable



## Standard models

The following table lists the standard models.

Table 2. Standard models

MTM*	Intel Xeon processor† (2 maximum)	Memory	RAID	Drive bays	Drives	Onboard NIC (std/max)	I/O slots (std/max)	Optical drive	Power (std/max)
Models announced May 2012									
7158-A2x	1x E5-2403 4C 1.8GHz 10MB 1066MHz 80W	1x 4 GB 1333 MHz§	C105	4x 3.5" SS / 4	Open bay	2x GbE / 4	2 / 5	Optional	1x 550 W HS / 2
7158-A4x	1x E5-2403 4C 1.8GHz 10MB 1066MHz 80W	1x 4 GB 1333 MHz§	C105	8x 3.5" SS / 8	Open bay	2x GbE / 4	2 / 5	Optional	1x 550 W HS / 2
7158-B2x	1x E5-2407 4C 2.2GHz 10MB 1066MHz 80W	1x 4 GB 1333 MHz§	C105	8x 3.5" HS / 8	Open bay	2x GbE / 4	2 / 5	Optional	1x 550 W HS / 2
7158-B4x	1x E5-2407 4C 2.2GHz 10MB 1066MHz 80W	1x 4 GB 1333 MHz§	M1115	12x 3.5" HS / 14	Open bay	2x GbE / 4	5 / 5	None	1x 750 W HS / 2
7158-C2x	1x E5-2420 6C 1.9GHz 15MB 1333MHz 95W	1x 4 GB 1333 MHz	M1115	8x 3.5" HS / 8	Open bay	2x GbE / 4	5 / 5	Optional	1x 550 W HS / 2
7158-C4x‡	1x E5-2420 6C 1.9GHz 15MB 1333MHz 95W	1x 8 GB 1333 MHz	M5110 512 MB	8x 3.5" HS / 8	1x 500 GB 7.2K SATA	2x GbE / 4	5 / 5	Multi- burner	1x 550 W HS / 2
7158-C6x‡	1x E5-2420 6C 1.9GHz 15MB 1333MHz 95W	1x 8 GB 1333 MHz	M5110 512 MB	12x 3.5" HS / 14	1x 500 GB 7.2K SATA	2x GbE / 4	5 / 5	None	1x 750 W HS / 2
7158-D2x	1x E5-2430 6C 2.2GHz 15MB 1333MHz 95W	1x 4 GB 1333 MHz	M5110 512 MB	12x 3.5" HS / 14	Open bay	2x GbE / 4	5 / 5	None	1x 750 W HS / 2
7158-F2x	1x E5-2440 6C 2.4GHz 15MB 1333MHz 95W	1x 4 GB 1333 MHz	M5110 512 MB (f)	12x 3.5" HS / 14	Open bay	2x GbE / 4	5 / 5	None	1x 750 W HS / 2
7158-F4x	1x E5-2440 6C 2.4GHz 15MB 1333MHz 95W	1x 4 GB 1333 MHz	M5110 512 MB (f)	8x 3.5" HS / 8	Open bay	2x GbE / 4	5 / 5	Optional	1x 550 W HS / 2
7158-G2x	1x E5-2450 8C 2.1GHz 20MB 1600MHz 95W	1x 4 GB 1333 MHz§	M5110 1 GB (f)	8x 3.5" HS / 8	Open bay	2x GbE / 4	5 / 5	Optional	1x 550 W HS / 2
7158-H2x	1x E5-2470 8C 2.3GHz 20MB 1600MHz 95W	1x 8 GB 1333 MHz§	M5110 1 GB (f)	12x 3.5" HS / 14	Open bay	2x GbE / 4	5 / 5	None	1x 750 W HS / 2
7158-J2x	1x E5-2450L 8C 1.8GHz 20MB 1600MHz 70W	1x 4 GB 1333 MHz§	M5110 1 GB (f)	12x 3.5" HS / 14	Open bay	2x GbE / 4	5 / 5	None	1x 750 W HS / 2

\* x in the Machine Type Model (MTM) represents a country-specific letter (for example, the EMEA MTM is 7158-A1G, and the US MTM is 7158-A1U). Ask your local IBM representative for specifics.

† Processor detail: Processor quantity and model, number of cores, core speed, L3 cache, memory speed, TDP.

§ For models A2x, A4x, B2x, and B4x, the standard DIMM is rated at 1333 MHz, but operates at up to 1066 MHz to match the processor memory speed. Conversely, for models G2x, H2x, and J2x, the processor memory speed is rated at 1600 MHz, but operates at up to 1333 MHz to match the rated speed of the installed DIMM. Actual memory speed maximums depend on several factors, as described in "Memory options".

‡ Models C4x and C6x include Windows Storage Server 2008 R2 Standard preload.

(f) The ServeRAID M5110 RAID controller in this model includes flash-backed cache.

Refer to the "Specifications" section for information about the standard features of the server.

## Express models

The following table lists the express models.

Table 3. Express models

MTM*	Intel Xeon processor† (2 maximum)	Memory	RAID	Drive bays	Drives	Onboard NIC (std/max)	I/O slots (std/ max)	Optical drive	Power (std/ max)
Central and Eastern Europe (CEE)									
7158-E1G	1x E5-2407 4C 2.2GHz 10MB 1066MHz 80W	1x 4 GB 1333 MHz§	M1115	8x 3.5" HS / 8	Open bay	2x GbE / 4	5 / 5	Multi- burner	1x 550 W HS / 2
7158-E2G#	1x E5-2420 6C 1.9GHz 15MB 1333MHz 95W	1x 8 GB 1333 MHz	M5110	8x 3.5" HS / 8	Open bay	2x GbE / 4	5 / 5	Multi- burner	1x 550 W HS / 2
7158-E3G‡	1x E5-2430 6C 2.2GHz 15MB 1333MHz 95W	1x 8 GB 1333 MHz	M5110 512 MB (f)	12x 3.5" HS / 14	2x 500 GB 7.2K SATA	2x GbE / 4	5 / 5	None	1x 750 W HS / 2
7158-E4G	1x E5-2420 6C 1.9GHz 15MB 1333MHz 95W	1x 8 GB 1333 MHz	M5110	8x 3.5" HS / 8	1x 500 GB 7.2K SATA	2x GbE / 4	5 / 5	Multi- burner	1x 550 W HS / 2
Europe (excluding CEE)									
7158-E1G	1x E5-2407 4C 2.2GHz 10MB 1066MHz 80W	1x 4 GB 1333 MHz§	M1115	8x 3.5" HS / 8	Open bay	2x GbE / 4	5 / 5	Multi- burner	1x 550 W HS / 2
7158-E2G	1x E5-2420 6C 1.9GHz 15MB 1333MHz 95W	1x 8 GB 1333 MHz	M5110	8x 3.5" HS / 8	Open bay	2x GbE / 4	5 / 5	Multi- burner	1x 550 W HS / 2
7158-E3G	1x E5-2430 6C 2.2GHz 15MB 1333MHz 95W	1x 8 GB 1333 MHz	M5110 512 MB (f)	12x 3.5" HS / 14	2x 500 GB 7.2K SATA	2x GbE / 4	5 / 5	None	1x 750 W HS / 2
Middle East, Africa									
7158-E1G	1x E5-2407 4C 2.2GHz 10MB 1066MHz 80W	1x 4 GB 1333 MHz§	M1115	8x 3.5" HS / 8	Open bay	2x GbE / 4	5 / 5	Multi- burner	1x 550 W HS / 2
7158-E3G	1x E5-2430 6C 2.2GHz 15MB 1333MHz 95W	1x 8 GB 1333 MHz	M5110 512 MB (f)	12x 3.5" HS / 14	2x 500 GB 7.2K SATA	2x GbE / 4	5 / 5	None	1x 750 W HS / 2
7158-E4G	1x E5-2420 6C 1.9GHz 15MB 1333MHz 95W	1x 8 GB 1333 MHz	M5110	8x 3.5" HS / 8	1x 500 GB 7.2K SATA	2x GbE / 4	5 / 5	Multi- burner	1x 550 W HS / 2
United States, Latin America, Canada									
7158-EAU	1x E5-2407 4C 2.2GHz 10MB 1066MHz 80W	1x 8 GB 1333 MHz§	M5110	8x 3.5" HS / 8	Open bay	2x GbE / 4	5 / 5	Multi- burner	1x 550 W HS / 2
7158-EBU	1x E5-2420 6C 1.9GHz 15MB 1333MHz 95W	1x 8 GB 1333 MHz	M5110 512 MB (f)	8x 3.5" HS / 8	Open bay	2x GbE / 4	5 / 5	Multi- burner	1x 550 W HS / 2
7158-ECU	1x E5-2440 6C 2.4GHz 15MB 1333MHz 95W	1x 8 GB 1333 MHz	M5110 1 GB (f)	8x 3.5" HS / 8	Open bay	2x GbE / 4	5 / 5	Multi- burner	1x 550 W HS / 2

\* MTM = Machine Type Model

† Processor detail: Processor quantity and model, number of cores, core speed, L3 cache, memory speed, TDP.

§ For models E1G and EAU, the standard DIMM is rated at 1333 MHz, but operates at up to 1066 MHz to match the processor memory speed. Actual memory speed maximums depend on several factors, as described in "Memory options".

# This model is available only in Russia/Commonwealth of Independent States (R/CIS).

‡ This model is not available in Russia/Commonwealth of Independent States (R/CIS).

(f) The ServeRAID M5110 RAID controller in this model includes flash-backed cache.

## Processor options

The x3630 M4 supports the processor options listed in the following table. The server supports up to two Intel Xeon processor E5-2400 product family processors, one Intel Xeon processor E5-1410, one Intel Pentium processor 1403, or one Intel Pentium processor 1407. This table shows which server models have each processor standard. If there is no corresponding *where used* model for a particular processor, then this processor is only available through CTO.

Table 3. Processor options

Part number	Description	Standard models where used
Single or dual processor support: Intel Xeon processor E5-2400 product family		
90Y6367	Intel Xeon Processor E5-2403 4C 1.8GHz 10MB Cache 1066MHz 80W	A2x, A4x
90Y6365	Intel Xeon Processor E5-2407 4C 2.2GHz 10MB Cache 1066MHz 80W	B2x, B4x
90Y6364	Intel Xeon Processor E5-2420 6C 1.9GHz 15MB Cache 1333MHz 95W	C2x, C4x, C6x
90Y6363	Intel Xeon Processor E5-2430 6C 2.2GHz 15MB Cache 1333MHz 95W	D2x
90Y6384	Intel Xeon Processor E5-2430L 6C 2.0GHz 15MB Cache 1333MHz 60W	-
90Y6362	Intel Xeon Processor E5-2440 6C 2.4GHz 15MB Cache 1333MHz 95W	F2x, F4x
90Y6361	Intel Xeon Processor E5-2450 8C 2.1GHz 20MB Cache 1600MHz 95W	G2x
90Y6368	Intel Xeon Processor E5-2450L 8C 1.8GHz 20MB Cache 1600MHz 70W	J2x
90Y6356	Intel Xeon Processor E5-2470 8C 2.3GHz 20MB Cache 1600MHz 95W	H2x
Single processor support only: Intel Xeon processor E5-1410 and Intel Pentium processor 1400 product family		
None*	Intel Pentium Processor 1403 2C 2.6GHz 5MB cache 1066MHz 80W	-
None*	Intel Pentium Processor 1407 2C 2.8GHz 5MB cache 1066MHz 80W	-
None*	Intel Xeon Processor E5-1410 4C 2.8GHz 10MB Cache 1333MHz 80W	-

\* These processors only support single processor configurations and are available only through CTO or special bid.

## Memory options

IBM DDR3 memory is compatibility tested and tuned for optimal System x performance and throughput. IBM memory specifications are integrated into the light path diagnostics for immediate system performance feedback and optimum system uptime. From a service and support standpoint, IBM memory automatically assumes the IBM system warranty, and IBM provides service and support worldwide.

The x3630 M4 supports DDR3 memory. The server supports up to six DIMMs when one processor is installed, and up to 12 DIMMs when two processors are installed. Each processor has three memory channels, and there are two DIMMs per channel. The following rules apply when selecting the memory configuration:

- Mixing different types of memory (UDIMMs, RDIMMs, and LRDIMMs) is not supported.
- Mixing 1.5 V and 1.35 V DIMMs in the same server is supported; in such cases, all DIMMs operate at 1.5 V.
- The maximum number of ranks supported per one channel is eight (with the exception of Load Reduced DIMMs, where more than eight ranks are supported because one quad-rank LRDIMM provides the same electrical load on a memory bus as a single-rank RDIMM).
- The maximum quantity of DIMMs that can be installed in a server depends on the number of processors (six DIMMs with one processor installed, 12 DIMMs with two processors installed)
- All DIMMs in all processor memory channels operate at the same speed, which is determined as the lowest value of:
  - The memory speed supported by the specific processor.
  - The lowest of maximum operating speeds for the selected memory configuration that depends on the rated speed, operating voltage, and quantity of DIMMs per channel, as shown under the "Maximum operating speed" section in Table 4.

Table 4. Maximum memory speeds (Part 1: RDIMMs)

Specification	DIMM type	RDIMM					
		Single rank			Dual rank		Quad rank
Rated speed		1333 MHz	1600 MHz	1333 MHz	1600 MHz	1066 MHz	
Rated voltage		1.35 V	1.5 V	1.35 V	1.5 V	1.35 V	
Operating voltage		1.35 V	1.5 V	1.5 V	1.35 V	1.5 V	1.35 V
Max quantity*		12	12	12	12	12	12
Largest DIMM		4 GB	4 GB	4 GB	16 GB	16 GB	8 GB
Max memory capacity		48 GB	48 GB	48 GB	192 GB	192 GB	96 GB
Max memory at rated speed		48 GB	48 GB	48 GB	192 GB	192 GB	96 GB
<b>Maximum operating speed (MHz)</b>							
1 DIMM per channel		1333 MHz	1333 MHz	1600 MHz	1333 MHz	1333 MHz	1600 MHz
2 DIMMs per channel		1333 MHz	1333 MHz	1600 MHz	1333 MHz	1333 MHz	1600 MHz

\* Maximum quantity supported is shown for two processors installed. When one processor is installed, the maximum quantity supported is a half of what is shown.

\*\* Rated speed is not supported. Memory DIMMs always operate at speeds lower than rated.

Table 4. Maximum memory speeds (Part 2: UDIMMs and LRDIMMs)

Specification	DIMM type		LRDIMM	
	UDIMM			
Rank	Dual rank		Quad rank	
Rated speed	1333 MHz		1333 MHz	
Rated voltage	1.35 V		1.35 V	
Operating voltage	1.35 V	1.5 V	1.35 V	1.5 V
Max quantity*	12	12	12	12
Largest DIMM	4 GB	4 GB	32 GB	32 GB
Max memory capacity	48 GB	48 GB	384 GB	384 GB
Max memory at rated speed	24 GB	24 GB	NS**	192 GB
<b>Maximum operating speed (MHz)</b>				
1 DIMM per channel	1333 MHz	1333 MHz	1066 MHz	1333 MHz
2 DIMMs per channel	1066 MHz	1066 MHz	800 MHz	1066 MHz

\* Maximum quantity supported is shown for two processors installed. When one processor is installed, the maximum quantity supported is a half of what is shown.

\*\* Rated speed is not supported. Memory DIMMs always operate at speeds lower than rated.

The following memory protection technologies are supported:

- ECC
- Chipkill (for x4-based memory DIMMs)
- Memory mirroring
- Memory rank sparing

Chipkill works only in independent channel mode (the default is operational mode) and supports only x4-based memory DIMMs.

If memory mirroring is used, then DIMMs must be installed in pairs (a minimum of one pair per each processor, and a maximum of two pairs per processor), and both DIMMs in a pair must be identical in type and size.

If memory rank sparing is used, then two single-rank or dual-rank DIMMs must be installed per populated channel (the DIMMs do not need to be identical). In rank sparing mode, one rank of a DIMM in each populated channel is reserved as spare memory. The size of a rank varies depending on the DIMMs installed.

Chipkill, memory mirroring, and memory rank sparing modes are mutually exclusive. Only one operational memory mode can be enabled on a server, and it is a system-wide setting.

The following table lists the memory options available for the x3630 M4 server.

Table 5. Memory options

Part number	Feature code	Description	Maximum supported	Standard models where used
<b>UDIMMs</b>				
49Y1404	8648	4GB (1x4GB, 2Rx8, 1.35V) PC3L-10600 CL9 ECC 1333MHz LP UDIMM	12 (6 per processor)	-
<b>RDIMMs</b>				
49Y1405	8940	2GB (1x2GB, 1Rx8, 1.35V) PC3L-10600 CL9 ECC DDR3 1333MHz LP RDIMM	12 (6 per processor)	-
49Y1406	8941	4GB (1x4GB, 1Rx4, 1.35V) PC3L-10600 CL9 ECC DDR3 1333MHz LP RDIMM	12 (6 per processor)	A2x, A4x, B2x, B4x, C2x, D2x, F2x, F4x, G2x, J2x
49Y1559	A28Z	4GB (1x4GB, 1Rx4, 1.5V) PC3-12800 CL11 ECC DDR3 1600MHz LP RDIMM	12 (6 per processor)	-
49Y1407	8942	4GB (1x4GB, 2Rx8, 1.35V) PC3L-10600 CL9 ECC DDR3 1333MHz LP RDIMM	12 (6 per processor)	-
90Y3178	A24L	4GB (1x4GB, 2Rx8, 1.5V) PC3-12800 CL11 ECC DDR3 1600MHz LP RDIMM	12 (6 per processor)	-
49Y1397	8923	8GB (1x8GB, 2Rx4, 1.35V) PC3L-10600 CL9 ECC 1333MHz LP RDIMM	12 (6 per processor)	C4x, C6x, H2x
90Y3109	A292	8GB (1x8GB, 2Rx4, 1.5V) PC3-12800 CL11 ECC DDR3 1600MHz LP RDIMM	12 (6 per processor)	-
49Y1399	A14E	8GB (1x8GB, 4Rx8, 1.35V) PC3L-8500 CL7 ECC DDR3 1066MHz LP RDIMM	12 (6 per processor)	-
49Y1563	A1QT	16GB (1x16GB, 2Rx4, 1.35V) PC3L-10600 CL9 ECC DDR3 1333MHz LP RDIMM	12 (6 per processor)	-
<b>LRDIMMs</b>				
90Y3105	A291	32GB (1x32GB, 4Rx4, 1.35V) PC3L-10600 CL9 ECC DDR3 1333MHz LP LRDIMM	12 (6 per processor)	-



## Internal disk storage options

The x3630 M4 server supports the following internal storage configurations:

- Four 3.5-inch SATA simple-swap drive bays
- Eight 3.5-inch SATA simple-swap drive bays
- Eight 3.5-inch SAS/SATA hot-swap drive bays
- Twelve 3.5-inch SAS/SATA hot-swap drive bays
- Fourteen 3.5-inch SAS/SATA hot-swap drive bays

In addition, four and eight bay models support the installation of either an internal optical drive or an internal tape drive.

The following figure shows some of these configurations.



Figure 7. Internal drive configurations

## Backplanes

Standard models ship with four or eight 3.5-inch SATA simple-swap drive bays or eight 3.5-inch SAS/SATA hot-swap drive bays. Storage-rich models ship with twelve 3.5-inch SAS/SATA hot-swap drive bays, and they can also be upgraded to fourteen 3.5-inch hot-swap drive bay models with the optional rear HDD cage assembly. The following table shows the internal storage expansion options that are available.

Table 6. Internal storage expansion options

Part number	Feature code	Description	Maximum supported	Standard models where used
00D9034	A1Z9	3.5" Hot Swap Cage Assembly, Rear, 2 x 3.5"	1	-
00D9051	A1ZL	x3630 M4 ODD Cage assembly	1	A2x, A4x, B2x, C2x, C4x, F4x, G2x
90Y6370	A1ZM	USB Tape Drive Cage assembling kit	1	-

Option 00D9034 is used to upgrade standard (see Table 2) or custom (CTO or special bid) models with twelve 3.5-inch hot-swap drive bays to fourteen 3.5-inch hot-swap drive bays. This option contains the HDD backplane, drive cage, signal and data cables, and two 1U riser cards: PCIe Riser Card 1 (1 x8 FH/HL + 1 x8 LP Slots) and PCIe Riser Card 2 (1 x4 LP for Slotless RAID). These 1U riser cards replace the standard 2U riser cards used in the models with twelve 3.5-inch hot-swap drive bays, limiting the maximum number of I/O slots to three (for more information, see the I/O expansion options section).

Option 00D9051 upgrades any four or eight bay model with an internal optical drive bay (for DVD-ROM or Multiburner). This option includes one USB cable and one power cable. The optical drive is ordered separately. This option is mutually exclusive with 90Y6370, Tape Drive Cage assembly.

**Note:** Option 00D9051, x3630 M4 ODD Cage assembly comes standard with every four or eight bay standard model listed in Table 2.

Option 90Y6370 upgrades any four or eight bay model with an internal tape drive bay (for DDS5 or DDS6 tape drives). This option includes one USB cable and one power cable. The tape drive is ordered separately. This option is mutually exclusive with 90Y6370, ODD Cage assembly.

## RAID controllers

The following table lists the RAID controllers and the additional options used for the internal disk storage of the x3630 M4 server.

Table 7. RAID controllers for internal storage

Part number	Feature code	Description	Maximum supported	Standard models where used
None#	A2VA	ServeRAID C105 for IBM System x	1	A2x, A4x, B2x
90Y4349§	A2V7	8-pack SATA Enabler for IBM System x	1	A4x, B2x
81Y4492	A1XL	ServeRAID H1110 SAS/SATA Controller	1	-
81Y4448	A1MZ	ServeRAID M1115 SAS/SATA Controller	1	B4x, C2x
81Y4542	A1X1	ServeRAID M1100 Series Zero Cache/RAID 5 Upgrade	1	-
81Y4481	A347	ServeRAID M5110 SAS/SATA Controller	1	C4x, C6x, D2x, F2x, F4x, G2x, H2x, J2x
81Y4544	A1X2	ServeRAID M5100 Series Zero Cache/RAID 5 Upgrade	1	-
81Y4484	A1J3	ServeRAID M5100 Series 512MB Cache/RAID 5 Upgrade	1	C4x, C6x, D2x
81Y4487	A1J4	ServeRAID M5100 Series 512MB Flash/RAID 5 Upgrade	1	F2x, F4x
81Y4559	A1WY	ServeRAID M5100 Series 1GB Flash/RAID 5 Upgrade	1	G2x, H2x, J2x
81Y4508	A22E	ServeRAID M5100 Series Battery Kit	1*	-
81Y4546	A1X3	ServeRAID M5100 Series RAID 6 Upgrade	1†	-
90Y4273	A2MC	ServeRAID M5100 Series Performance Accelerator for IBM System x	1	-
90Y4318	A2MD	ServeRAID M5100 Series SSD Caching Enabler for IBM System x	1	-
46M0912	3876	IBM 6Gb Performance Optimized HBA	1	-

# The ServeRAID C105 is an onboard software RAID controller.

§ An FoD upgrade for ServeRAID C105 that supports eight SATA HDDs.

\* The ServeRAID M5100 Series Battery Kit (81Y4508) is only supported with ServeRAID M5100 Series 512MB Cache/RAID 5 Upgrade (81Y4484).

† The ServeRAID M5100 Series RAID 6 Upgrade (81Y4546) requires RAID 5 Upgrade with caches (81Y4484, 81Y4487, or 81Y4559).

The internal hardware RAID controller is installed into a dedicated PCIe slot (slot 3 for models with 14 drive bays or slot 5 for models with up to 12 drive bays). See Table 12 and Table 13 (PCI riser card options) for more details.

The following table lists drive types and internal drive bay configurations supported by the RAID controllers (SAS HDDs include both SAS and NL SAS HDDs, and SATA HDDs include both SATA and NL SATA HDDs).

Table 8. Drive types and internal drive bay configurations supported by the RAID controllers

RAID controller	Drive type	8x 3.5-in. hot-swap	12x 3.5-in. hot-swap	14x 3.5-in. hot-swap	4x 3.5-in. simple-swap	8x 3.5-in. simple-swap
ServeRAID C105	SAS HDD	No support	No support	No support	No support	No support
	SATA HDD	Yes*	No support	No support	Yes	Yes*
	SATA SSD	No support	No support	No support	No support	No support
ServeRAID H1110	SAS HDD	No support	No support	No support	Yes	No support
	SATA HDD	No support	No support	No support	Yes	No support
	SATA SSD	No support	No support	No support	No support	No support
ServeRAID M1115	SAS HDD	Yes	Yes	Yes	Yes	Yes
	SATA HDD	Yes	Yes	Yes	Yes	Yes
	SATA SSD	Yes	Yes	Yes	Yes	Yes
ServeRAID M5110	SAS HDD	Yes	Yes	Yes	Yes	Yes
	SATA HDD	Yes	Yes	Yes	Yes	Yes
	SATA SSD	Yes	Yes	Yes	Yes	Yes
6Gb Performance Optimized HBA	SAS HDD	Yes	Yes	Yes	Yes	Yes
	SATA HDD	Yes	Yes	Yes	Yes	Yes
	SATA SSD	Yes	Yes	Yes	Yes	Yes

\* Requires an FoD upgrade for ServeRAID C105 that supports eight SATA HDDs (8-pack SATA Enabler, part number 90Y4349).

The ServeRAID C105 onboard controller has the following specifications:

- Supports up to eight (up to four standard, with an additional four with optional 8-pack enabler, 90Y4349) SATA HDDs (SAS not supported)
- Supports hot-swap and simple-swap drives
- Support for RAID 0 and RAID 1 (non-RAID is not supported.)
- Up to 3 Gbps throughput per port
- Support for up to two volumes
- Support for virtual drive sizes greater than 2 TB
- Fixed stripe unit size of 64 KB
- Support for MegaRAID Storage Manager management software

The ServeRAID H1110 adapter has the following specifications:

- Four internal 6 Gbps SAS/SATA ports
- One x4 mini-SAS internal connector (SFF-8087)
- Up to 6 Gbps throughput per port
- Based on the LSI SAS2004 6 Gbps RAID on Chip (ROC) controller
- PCIe 2.0 x4 host interface
- Supports RAID 0, 1, 1E, and 10
- Connects to up to four SAS or SATA drives (SAS expanders are not supported.)

The ServeRAID M1115 SAS/SATA Controller has the following specifications:

- Eight internal 6 Gbps SAS/SATA ports
- Two x4 mini-SAS internal connectors (SFF-8087)
- Supports connections to SAS/SATA drives and SAS Expanders
- Supports RAID levels 0, 1, and 10
- Supports RAID levels 5 and 50 with optional M1100 Series RAID 5 upgrades
- Up to 6 Gbps throughput per port
- PCIe 2.0 x8 host interface
- Based on the LSI SAS2008 6 Gbps ROC controller

The ServeRAID M5110 SAS/SATA Controller has the following specifications:

- Eight internal 6 Gbps SAS/SATA ports
- Two x4 mini-SAS internal connectors (SFF-8087)
- Supports connections to SAS/SATA drives and SAS Expanders
- Supports RAID levels 0, 1, and 10
- Supports RAID levels 5 and 50 with optional M5100 Series RAID 5 upgrades
- Supports RAID 6 and 60 with the optional M5100 Series RAID 6 Upgrade
- Supports 512 MB battery-backed cache or 512 MB or 1 GB flash-backed cache
- Support for SSD performance optimization with the optional M5100 Series Performance Accelerator and SSD Caching Enabler
- Up to 6 Gbps throughput per port
- PCIe 3.0 x8 host interface
- Based on the LSI SAS2208 6 Gbps ROC controller

The IBM 6Gb Performance Optimized HBA has the following specifications:

- Eight internal 6 Gbps SAS/SATA ports
- Two x4 mini-SAS internal connectors (SFF-8087)
- Supports connections to SAS/SATA HDDs and SATA SSDs
- Optimized for SSD performance
- No RAID support
- Up to 6 Gbps throughput per port
- PCIe 2.0 x8 host interface
- Based on the LSI SAS2008 6 Gbps ROC controller

For more information, see the list of IBM Redbooks Product Guides in the RAID adapters category:  
<http://www.redbooks.ibm.com/portals/systemx?Open&page=pg&cat=raid>

## Drive options for internal storage

The following table lists hard drive options for internal disk storage of the x3630 M4 server.

Table 9. Disk drive options for internal disk storage

Part number	Feature code	Description	Maximum supported
<b>3.5" SAS Hot-Swap HDDs</b>			
49Y6092	A3DV	IBM 300GB 15K 6Gbps SAS 3.5" G2HS HDD	14
49Y6097	A3DW	IBM 450GB 15K 6Gbps SAS 3.5" G2HS HDD	14
49Y6102	A3DX	IBM 600GB 15K 6Gbps SAS 3.5" G2HS HDD	14
<b>3.5" NL SAS Hot-Swap HDDs</b>			
90Y8567	A26M	IBM 1TB 7.2K 6Gbps NL SAS 3.5" G2HS HDD	14
90Y8572	A2U0	IBM 2TB 7.2K 6Gbps NL SAS 3.5" G2HS HDD	14
00W1533	A4AH	IBM 2TB 7.2K 6Gbps NL SAS 3.5" G2HS SED	14
90Y8577	A2R2	IBM 3TB 7.2K 6Gbps NL SAS 3.5" G2HS HDD	14
49Y6210	A4AF	IBM 4TB 7.2K 6Gbps NL SAS 3.5" G2HS HDD	14
00W1543	A4AJ	IBM 4TB 7.2K 6Gbps NL SAS 3.5" G2HS SED	14
<b>3.5" NL SATA Hot-Swap HDDs</b>			
81Y9786	A22Y	IBM 500GB 7.2K 6Gbps NL SATA 3.5" G2HS HDD	14
81Y9790	A22P	IBM 1TB 7.2K 6Gbps NL SATA 3.5" G2HS HDD	14
81Y9794	A22T	IBM 2TB 7.2K 6Gbps NL SATA 3.5" G2HS HDD	14
81Y9798	A22S	IBM 3TB 7.2K 6Gbps NL SATA 3.5" G2HS HDD	14
49Y6002	A3W9	IBM 4TB 7.2K 6Gbps NL SATA 3.5" G2HS HDD	14
<b>3.5" NL SATA Simple-Swap HDDs</b>			
81Y9802	A22U	IBM 500GB 7.2K 6Gbps NL SATA 3.5" G2SS HDD	8
81Y9806	A22X	IBM 1TB 7.2K 6Gbps NL SATA 3.5" G2SS HDD	8
81Y9810	A22W	IBM 2TB 7.2K 6Gbps NL SATA 3.5" G2SS HDD	8
81Y9814	A22V	IBM 3TB 7.2K 6Gbps NL SATA 3.5" G2SS HDD	8
49Y6012	A3WA	IBM 4TB 7.2K 6Gbps NL SATA 3.5" G2SS HDD	8
<b>3.5" SATA Hot-Swap SSDs</b>			
00W1286	A3G1	IBM 64GB SATA 3.5" MLC HS Enterprise Value SSD	14
00W1291	A3G3	IBM 128GB SATA 3.5" MLC HS Enterprise Value SSD	14
00W1296	A3G4	IBM 256GB SATA 3.5" MLC HS Enterprise Value SSD	14
00W1301	A3G2	IBM 512GB SATA 3.5" MLC HS Enterprise Value SSD	14



## Internal backup units

The server supports the internal backup options listed in the following table. The USB Tape Drive Cage assembling kit, part number 90Y6370, is required to support these tapes internally. The internal tape drive is connected to the dedicated internal USB port on a system board.

Table 10. Internal tape drives

Part number	Feature code	Description	Maximum supported
90Y6370	A1ZM	USB Tape Drive Cage assembling kit	1
46C5399	5711	IBM DDS Generation 5 USB Tape Drive	1
39M5636	5395	IBM DDS Generation 6 USB Tape Drive	1

For more information, see the list of IBM Redbooks Product Guides in the Backup units category:  
<http://www.redbooks.ibm.com/portals/systemx?Open&page=pg&cat=tape>

## Optical drives

The server supports the optical drive options listed in the following table. The installation of optical drive may require x3630 M4 ODD Cage assembly, part number 00D9051. Standard models of x3630 M4 with four or eight HDDs ship with the ODD Cage assembly installed. Server models with twelve 3.5-inch HDDs do not support an internal optical drive.

Table 11. Optical drives

Part number	Feature code	Description	Maximum supported	Standard models where used
46M0901	4161	IBM UltraSlim Enhanced SATA DVD-ROM	1	-
46M0902	4163	UltraSlim Enhanced SATA Multi-Burner	1	C4x

IBM UltraSlim Enhanced SATA DVD-ROM (part number 46M0901) supports the following media and speeds for reading:

- CD-ROM 24X
- CD-R 24X
- CD-RW 24X
- DVD-ROM (4.7 GB) 8X
- DVD-ROM (dual layer, 8.5 GB) 8X
- DVD-R (4.7 GB) 8X
- DVD-R (dual layer, 8.5 GB) 8X
- DVD+R (4.7 GB) 8X
- DVD+R (dual layer, 8.5 GB) 8X
- DVD-RW (4.7 GB) 8X
- DVD+RW (4.7 GB) 8X
- DVD-RAM (4.7 GB) 5X

IBM UltraSlim Enhanced SATA Multi-Burner (46M0902) supports the same media and speeds for reading as DVD-ROM (46M0901). This drive also supports the following media and speeds for writing:

- CD-R 24X
- CD-RW 4X
- High Speed CD-RW 10X
- Ultra Speed CD-RW 24X
- Ultra Speed Plus CD-RW 24X
- DVD-R (4.7 GB) 8X
- DVD-R (dual layer, 8.5 GB) 6X
- DVD+R (4.7 GB) 8X
- DVD+R (dual layer, 8.5 GB) 6X
- DVD-RW (4.7 GB) 6X
- DVD+RW (4.7 GB) 8X
- DVD-RAM (4.7 GB) 5X

## I/O expansion options

The server supports up to five PCIe slots with different riser cards installed into two riser sockets on the system planar (one riser socket supports the installation of one riser card). There are two types of riser cards: 2U risers and 1U risers. 2U risers are used in x3630 M4 models that do not have the rear HDD cage assembly (see Figure 4). 1U risers are used in models with the rear HDD cage assembly installed (see Figure 5). See Figure 4 and Figure 5 for slot locations and numbering.

**Note:** You cannot use 1U risers in models without the rear HDD cage. You cannot use 2U risers in models with the rear HDD cage assembly installed.

The slot form factors with 2U risers (models without the rear HDD cage assembly) are as follows:

- Slot 1: PCIe 3.0 x16 (x8-wired), optional PCIe 3.0 x16 (x16-wired); full-height, full-length
- Slot 2: PCIe 3.0 x16 (x8-wired); full-height, half-length (not present if optional x16-wired slot 1 riser is used)
- Slot 3: PCIe 3.0 x16 (x8-wired), optional PCIe 3.0 x16 (x16-wired); low-profile, half-length (the second processor is required to use this slot)
- Slot 4: PCIe 3.0 x16 (x8-wired); low-profile, half-length (not present if optional x16-wired slot 3 riser is used, the second processor is required to use this slot)
- Slot 5: PCIe 3.0 x8 (x4-wired); dedicated slot for ServeRAID adapter; standard on hardware RAID models, optional on software RAID models

**Note:** Standard models with software RAID (ServeRAID C105) ship with one 2U riser supplying slots 1 and 2 (slots 3, 4, and 5 are not present). Standard models with hardware RAID adapters (ServeRAID M1115 or M5110) ship with two 2U risers supplying all five slots. See Table 10 for details.

The slot form factors with 1U risers (models with the rear HDD cage assembly) are as follows:

- Slot 1: PCIe 3.0 x8 (x8-wired), optional PCIe 3.0 x16 (x16-wired); full-height, half-length
- Slot 2: PCIe 3.0 x8 (x8-wired); low-profile, half-length (not present if an optional x16-wired slot 1 riser is used)
- Slot 3: PCIe 3.0 x8 (x4-wired), optional PCIe 3.0 x8 (x8-wired); dedicated slot for ServeRAID adapter (x8-wired slot requires the second processor, x4-wired slot does not require the second processor)

**Note:** The 3.5" Hot Swap Cage Assembly, Rear, 2 x 3.5" option, part number 00D9034, ships with two 1U risers supplying x8-wired slots 1 and 2 and x4-wired slot 3. See Table 10 for details.

The following two tables lists the I/O riser card options, the 2U riser options and the 1U riser options.

Table 12. 2U I/O riser card options

Part number	Feature code	Description	Maximum supported	Standard models where used
2U Riser 1 option (supplies slots 1 and 2)				
None*	A1ZE	PCIe Riser Card 1 (1 x8 FH/FL + 1 x8 FH/HL Slots)	1	A2x, A4x, B2x, B4x, C2x, C4x, C6x, D2x, F2x, F4x, G2x, H2x, J2x
90Y6381	A1ZG	PCIe Riser Card 1 (1 x16 FH/FL Slot) (Riser Kit for Slot 1)	1	-
2U Riser 2 option (supplies slot 3, 4, and 5)				
00D8604	A1ZF	PCIe Riser Card 2 (2 x8 LP Slots + 1 x4 LP for Slotless RAID)	1	B4x, C2x, C4x, C6x, D2x, F2x, F4x, G2x, H2x, J2x
90Y6383	A1ZH	PCIe Riser Card 2 (1 x16 LP Slot + 1 x4 LP for Slotless RAID) (Riser kit for Slot 2 with Slotless RAID)	1	-

\* This riser card is installed in all standard models. It can also be used in CTO or special bid models.

Table 13. 1U I/O riser card options

Part number	Feature code	Description	Maximum supported	Standard models where used
1U Riser 1 option (supplies slots 1 and 2)				
None†	A1ZA	PCIe Riser Card 1 (1 x8 FH/HL + 1 x8 LP Slots)	1	-
None*	A1ZB	PCIe Riser Card 1 (1 x16 FH/HL Slot) for Graphic card	1	-
1U Riser 2 option (supplies slot 3)				
None†	A1ZC	PCIe Riser Card 2 (1 x4 LP for Slotless RAID)	1	-
00D8603	A1ZD	PCIe Riser Card 2 (1 x8 LP for Slotless RAID)	1	-

† These riser cards come standard with the 3.5" Hot Swap Cage Assembly, Rear, 2 x 3.5" option (00D9034).

\* This riser card is only available through CTO or special bid models.

## Network adapters

The x3630 M4 supports up to four integrated Gigabit Ethernet ports (two enabled standard, and two enabled optionally with the FoD upgrade). Integrated NIC has the following features:

- An Intel I350-CM2 chip
- Up to four Gigabit Ethernet ports (two enabled standard, and two enabled optionally with the 90Y9314 FoD upgrade)
- NIC Teaming (load balancing and failover)

- Ethernet Features:
  - 1 Gb Ethernet IEEE 802.3, 802.3u, and 802.3ab PHY specifications compliant
  - Integrated PHY for 10/100/1000 Mbps for multispeed, full, and half-duplex auto-negotiation
  - IEEE 802.3x and 802.3z compliant flow control support with software-controllable Rx thresholds and Tx pause frames
  - Automatic cross-over detection function (MDI/MDI-X)
  - IEEE 1588 protocol and 802.1AS implementation
  - IEEE802.3az - Energy Efficient Ethernet (EEE)
  - Full wake up support
    - Advanced Power Management (APM) support
    - Advanced Configuration and Power Interface (ACPI) specification v2.0c
    - Magic packet wake-up enable
  
- I/O Virtualization Features:
  - Eight transmit (Tx) and receive (Rx) queue pairs per port
  - Flexible port partitioning: 32 virtual functions (VF) with four ports or 16 VFs with two ports
  - Rx/Tx round-robin scheduling
  - Traffic isolation and traffic steering
  - Virtual machine (VM) to VM packet forwarding (packet loopback)
  - MAC and VLAN anti-spoofing
  - Malicious driver detection
  - Storm control
  - Per-pool statistics, off loads, and jumbo support
  - Independent Function Level Reset (FLR) for physical and virtual functions
  - IEEE 802.1q Virtual Local Area Network (VLAN) support with VLAN tag insertion, stripping, and packet filtering for up to 4096 VLAN tags
  - IEEE 802.1q advanced packet filtering
  - Mirroring rules
  - Support for simple VEPA
  - VF promiscuous modes
  
- Stateless offload and performance features:
  - TCP/UDP, IPv4 checksum offloads (Rx/ Tx/Large-send); extended Tx descriptors
  - IPv6 support for IP/TCP and IP/UDP receive checksum offload
  - Tx TCP segmentation offload (IPv4, IPv6)
  - Transmit Segmentation Offloading (TSO)
  - Interrupt throttling control
  - Legacy and Message Signal Interrupt (MSI)
  - Message Signal Interrupt Extension (MSI-X)
  - Receive Side Scaling (RSS) for Windows
  - Scalable I/O for Linux environments (IPv4, IPv6, TCP/UDP)
  - Support for packets up to 9.5 KB (jumbo frames)

The following table lists additional supported network adapters.

Table 14. Network adapters

Part number	Feature code	Description	Maximum supported
40 Gb Ethernet / FDR InfiniBand			
00D9550	A3PN	Mellanox ConnectX-3 FDR VPI IB/E Adapter for IBM System x	4
10 Gb Ethernet			
49Y7910	A18Y	Broadcom NetXtreme II Dual Port 10GBaseT Adapter for IBM System x	4
42C1820	1637	Brocade 10 Gb Dual-port CNA for IBM System x	4*
95Y3762	A2U1	Emulex Dual Port 10GbE SFP+ VFA III for IBM System x	4*
None**	A2UN	Emulex Dual Port 10GbE SFP+ Integrated VFA III for IBM System x	4*
95Y3760	A2U2	Emulex VFA III FCoE/iSCSI License for IBM System x (FoD)	4†
49Y7960	A2EC	Intel X520-DA2 Dual Port 10GbE SFP+ Adapter for IBM System x	4
49Y7970	A2ED	Intel X540-T2 Dual Port 10GBaseT Adapter for IBM System x	4
00D9690	A3PM	Mellanox ConnectX-3 10GbE Adapter for IBM System x	4
42C1800	5751	QLogic 10Gb CNA for IBM System x	4*
90Y4600	A3MR	Qlogic 8200 Dual Port 10GbE SFP+ VFA for IBM System x	4*
00Y5624	A3MT	Qlogic 8200 VFA FCoE/iSCSI License for IBM System x (FoD)	4‡
Integrated NIC upgrades			
90Y9314	A2GT	Intel I-350 Embedded Dual Port GbE Activation for IBM System x (FoD)	1
Gigabit Ethernet			
39Y6066	1485	NetXtreme II 1000 Express Ethernet Adapter	4
42C1780	2995	NetXtreme II 1000 Express Dual Port Ethernet Adapter	4
49Y4220	5766	NetXtreme II 1000 Express Quad Port Ethernet Adapter	4
42C1750	2975	PRO/1000 PF Server Adapter by Intel	4
49Y4230	5767	Intel Ethernet Dual Port Server Adapter I340-T2 for IBM System x	4
49Y4240	5768	Intel Ethernet Quad Port Server Adapter I340-T4 for IBM System x	4
90Y9352	A2V3	Broadcom NetXtreme I Quad Port GbE Adapter for IBM System x	4
90Y9370	A2V4	Broadcom NetXtreme I Dual Port GbE Adapter for IBM System x	4

† One FCoE/iSCSI license per one Emulex Dual Port VFA III or Integrated VFA III.

‡ One FCoE/iSCSI license per one QLogic 8200 Dual Port VFA.

\* Virtual Fabric Adapters and Converged Network Adapters require SFP+ optical transceivers or DAC cables that must be purchased separately.

\*\* This adapter can only be ordered through CTO or special bid.

For more information, see the list of IBM Redbooks Product Guides in the Ethernet and IB adapters category:

<http://www.redbooks.ibm.com/portals/systemx?Open&page=pg&cat=networkadapters>

## Storage host bus adapters

The following table lists storage HBAs supported by the x3630 M4 server.

Table 15. Storage adapters

Part number	Feature code	Description	Maximum supported
<b>Fibre Channel - 16 Gb</b>			
81Y1668	A2XU	Brocade 16Gb FC Single-port HBA for IBM System x	4
81Y1675	A2XV	Brocade 16Gb FC Dual-port HBA for IBM System x	4
81Y1662	A2W6	Emulex 16Gb FC Dual-port HBA for IBM System x	4
81Y1655	A2W5	Emulex 16Gb FC Single-port HBA for IBM System x	4
00Y3337	A3KW	QLogic 16Gb FC Single-port HBA for IBM System x	4
00Y3341	A3KX	QLogic 16Gb FC Dual-port HBA for IBM System x	4
<b>Fibre Channel - 8 Gb</b>			
46M6050	3591	Brocade 8Gb FC Dual-port HBA for IBM System x	4
46M6049	3589	Brocade 8Gb FC Single-port HBA for IBM System x	4
42D0494	3581	Emulex 8Gb FC Dual-port HBA for IBM System x	4
42D0485	3580	Emulex 8Gb FC Single-port HBA for IBM System x	4
42D0510	3579	QLogic 8Gb FC Dual-port HBA for IBM System x	4
42D0501	3578	QLogic 8Gb FC Single-port HBA for IBM System x	4
<b>Fibre Channel - 4 Gb</b>			
59Y1993	3886	Brocade 4Gb FC Dual-port HBA for IBM System x	4
59Y1987	3885	Brocade 4Gb FC Single-port HBA for IBM System x	4
42C2071	1699	Emulex 4Gb FC Dual-Port PCI-E HBA for IBM System x	4
42C2069	1698	Emulex 4Gb FC Single-Port PCI-E HBA for IBM System x	4
39R6525	3567	Qlogic 4Gb FC Single-Port PCIe HBA for System x	4
39R6527	3568	Qlogic 4Gb FC Dual-Port PCIe HBA for System x	4
<b>SAS</b>			
46M0907	5982	IBM 6Gb SAS HBA Controller	4

For more information, see the list of IBM Redbooks Product Guides in the Host bus adapters category:

<http://www.redbooks.ibm.com/portals/systemx?Open&page=pg&cat=hba>



## PCIe SSD adapters

The server supports the High IOPS SSD adapters listed in the following table.

Table 16. SSD adapters

Part number	Feature code	Description	Maximum supported
46C9078	A3J3	IBM 365GB High IOPS MLC Mono Adapter	3
46C9081	A3J4	IBM 785GB High IOPS MLC Mono Adapter	3
90Y4377	A3DY	IBM 1.2TB High IOPS MLC Mono Adapter	3
90Y4361	A3MZ	IBM 300GB High IOPS MLC Modular Adapter	4
90Y4365	A3N0	IBM 600GB High IOPS MLC Modular Adapter	4
90Y4369	A3N1	IBM 800GB High IOPS MLC Modular Adapter	4
90Y4373	A3N2	IBM 300GB High IOPS SLC Modular Adapter	4

## GPU adapters

The server supports graphics processing units (GPUs) provided riser card 90Y6381 or FC A1ZB is installed. The following table lists the supported GPUs.

Table 17. GPU adapters

Part number	Feature code	Description	Maximum supported
None*	A13K	NVIDIA Quadro 600	1
None*	A1QU	NVIDIA Quadro 2000	1
94Y5957	4798	NVIDIA Quadro 4000	1

\* This adapter can only be ordered through CTO or special bid.

The use of GPU adapters with 4x 3.5-inch or 8x 3.5-inch drive bay models requires installation of one or two 750 W power supplies. The use of GPU adapters with 12x 3.5-inch or 14x 3.5-inch drive bay models requires installation of one or two 900 W power supplies. 550 W power supplies are not supported with GPU adapters.

## Power supplies

The server supports up to two redundant hot-swap 550 W AC, 750 W AC, 900 W AC, or 750 W DC high efficient power supplies. AC power supplies are 80 PLUS Platinum certified. Standard models come with one 550 W AC (models with up to eight drive bays) or 750 W AC (storage-rich models with up to 14 drive bays) hot-swap power supply.

The following table lists the power supply options. An AC hot-swap power supply option ships standard with one 2.8m, 10A/100-250V, C13 to IEC 320-C14 rack power cable.

Table 18. Power supplies

Part number	Feature code	Description	Maximum supported	Standard models where used
94Y6668	A1H6	IBM System x 550W High Efficiency Platinum AC Power Supply	2	A2x, A4x, B2x, C2x, C4x, F4x, G2x
94Y6669	A1H5	IBM System x 750W High Efficiency Platinum AC Power Supply	2	B4x, C6x, D2x, F2x, H2x, J2x
94Y6667	A2EB	IBM System x 900W High Efficiency Platinum AC Power Supply	2	-
94Y7631	A39N	IBM System x 750W High Efficiency -48 V DC Power Supply	2	-

**Note:** If you plan to use GPU adapters, refer to the "GPU adapters" section for the additional power supply selection guidelines.

## Integrated virtualization

The server supports VMware ESXi installed on a USB memory key. The key is installed in a USB socket inside the server. The following table lists the virtualization options.

Table 19. Virtualization options

Part number	Feature code	Description	Maximum supported
41Y8298	A2G0	IBM Blank USB Memory Key for VMware ESXi Downloads	1
41Y8300	A2VC	IBM USB Memory Key for VMware vSphere 5.0	1
41Y8311	A2R3	IBM USB Memory Key for VMWare ESXi 5.1	1

## Remote management

The server contains IBM Integrated Management Module II (IMM2), which provides advanced service-processor control, monitoring, and an alerting function. If an environmental condition exceeds a threshold or if a system component fails, the IMM2 lights LEDs to help you diagnose the problem, records the error in the event log, and alerts you to the problem. Optionally, the IMM2 also provides a virtual presence capability for remote server management capabilities.

The IMM2 provides remote server management through industry-standard interfaces:

- Intelligent Platform Management Interface (IPMI) Version 2.0
- Simple Network Management Protocol (SNMP) Version 3
- Common Information Model (CIM)
- Web browser

The optional IBM Integrated Management Module Advanced Upgrade is required to enable the remote presence and blue-screen capture features. The remote presence feature provides the following functions:

- Remotely viewing video with graphics resolutions up to 1600x1200 at 75 Hz with up to 23 bits per pixel, regardless of the system state
- Remotely accessing the server using the keyboard and mouse from a remote client
- Mapping the CD or DVD drive, diskette drive, and USB flash drive on a remote client, and mapping ISO and diskette image files as virtual drives that are available for use by the server
- Uploading a diskette image to the IMM memory and mapping it to the server as a virtual drive

The blue-screen capture feature captures the video display contents before the IMM restarts the server when the IMM detects an operating system hang condition. A system administrator can use the blue-screen capture to assist in determining the cause of the hang condition. The following table lists the remote management option.

Table 20. Remote management option

Part number	Feature code	Description	Maximum supported
90Y3901	A1ML	IBM Integrated Management Module Advanced Upgrade	1

In the default UEFI configuration, Ethernet port 2 is configured to be dedicated to remote access to the IMM2. If preferred, you can change the UEFI setting so that remote access to the IMM2 is via Port 1 and also accessible to the operating system. This Shared setting is also useful if you do not have a dedicated management network -- management and production networks are combined into a single network. The following table shows this setting and its effect on the Ethernet ports.

Table 21. UEFI settings for remote access to the IMM

UEFI mode	Ethernet Port 1	Ethernet Port 2	Ethernet Port 3 (optional)	Ethernet Port 4 (optional)
IMM network interface port dedicated (default)	Production Ethernet	IMM2 dedicated	Production Ethernet	Production Ethernet
IMM network interface port shared	Shared - Production Ethernet and IMM2	Production Ethernet	Production Ethernet	Production Ethernet

## Light path diagnostics panel

The light path diagnostics panel allows system engineers and administrators to easily and quickly diagnose hardware problems on the IBM System x servers. If a failure occurs, a light is illuminated on the front panel of the server (level 1 light path) to alert the systems administrator that there is a problem. The pop-out light path diagnostics panel (light path level 2) has a light against the failed subsystem. This light directs the engineer or administrator directly to the failed component, which also has an illuminated LED near it (light path level 3), for example, the DIMM error LED on the system board.

x3630 M4 offers two variants of light path diagnostics: basic and advanced. All standard x3630 M4 models include basic functionality that provides light path levels 1 and 3. Advanced functionality is optional, and contains a pop-out panel that adds light path level 2. Storage-rich x3630 M4 servers (servers with 12 or 14 drive bays) only support basic light path.

The following figures show basic (level 1) and advanced (level 2) light path levels.

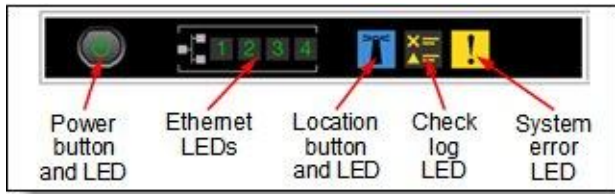

Figure 8. Basic (level 1) light path for models with eight drive bays

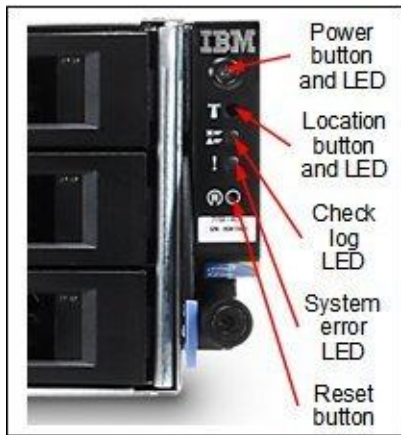

Figure 9. Basic (level 1) light path for storage-rich models

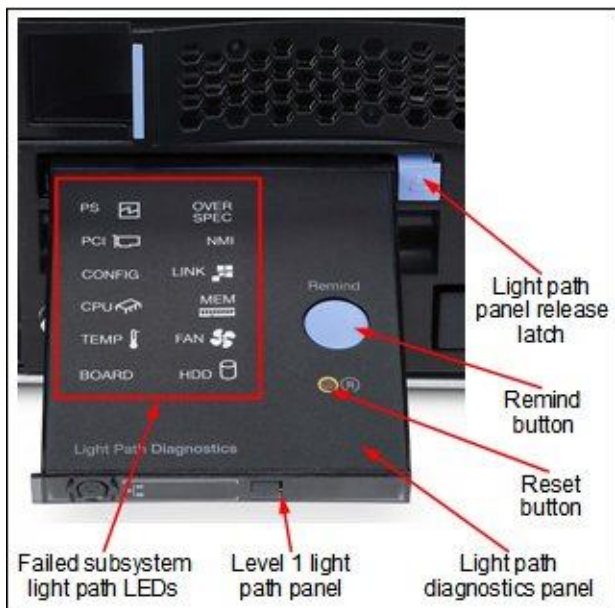

Figure 10. Advanced (level 2) light path for models with eight drive bays

The following table lists the advanced light path kit.

Table 22. Advanced light path kit

Part number	Feature code	Description	Maximum supported
90Y6533	A1LE	Lightpath Upgrade kit	1

## Supported operating systems

The server supports the following operating systems:

- Microsoft Windows Server 2012
- Microsoft Windows Server 2008 R2
- Microsoft Windows Server 2008, Datacenter x64 Edition
- Microsoft Windows Server 2008, Web x64 Edition
- Microsoft Windows Small Business Server 2008 Premium Edition
- Microsoft Windows Small Business Server 2008 Standard Edition
- Red Hat Enterprise Linux 5 Server Edition
- Red Hat Enterprise Linux 5 Server with Xen x64 Edition
- Red Hat Enterprise Linux 5 Server x64 Edition
- Red Hat Enterprise Linux 6 Server Edition
- Red Hat Enterprise Linux 6 Server x64 Edition
- SUSE LINUX Enterprise Server 10 for AMD64/EM64T
- SUSE LINUX Enterprise Server 10 for x86
- SUSE LINUX Enterprise Server 11 for AMD64/EM64T
- SUSE LINUX Enterprise Server 11 for x86
- SUSE LINUX Enterprise Server 11 with Xen for AMD64/EM64T
- VMware ESX 4.1
- VMware ESXi 4.1
- VMware vSphere 5
- VMware vSphere 5.1

For the latest information about the specific versions and service levels supported and any other prerequisites, see the IBM ServerProven® website at:

<http://www.ibm.com/systems/info/x86servers/serverproven/compat/us/nos/matrix.shtml>

## Physical and electrical specifications

Dimensions and weight:

- Height: 86 mm (3.4 in.)
- Width: 447 mm (17.6 in.)
- Depth: 749 mm (29.5 in.)
- Weight:
  - Minimum configuration: 16.4 kg (36.2 lb).
  - Maximum configuration: 28.2 kg (62.2 lb).

Supported environment:

- Air temperature
  - Server on: 5 °C - 40 °C (41.0 °F - 104 °F); altitude: 0 - 915 m (3,000 ft).
  - Server on: 5 °C - 32 °C (41.0 °F - 89.6 °F); altitude: 915 - 2,134 m (7,000 ft).
  - Server on: 5 °C - 28 °C (41.0 °F - 82.4 °F); altitude: 2,134 - 3,050 m (10,000 ft).
  - Server off: 5 °C - 45 °C (41.0 °F - 113 °F).
  - Shipment: -40 °C - 60 °C (-40 °F - 140 °F).

- Humidity:
  - Server on: 8% - 85%, maximum dew point 24 °C, maximum rate of change 5 °C/hr.
  - Server off: 8% - 80%, maximum dew point 27 °C.
  - Shipment: 5% - 100%.
- Design to ASHRAE Class A3, ambient of 35 °C - 40 °C, with relaxed support:
  - Support cloud like workload with no performance degradation acceptable (Turbo-Off).
  - Under no circumstance can any combination of worst case workload and configuration result in system shutdown or design exposure at 40 °C.
- Electrical
  - Models with 900 W power supplies:
    - 100 to 127 (nominal) V ac; 50 Hz or 60 Hz; 10 A
    - 200 to 240 (nominal) V ac; 50 Hz or 60 Hz; 5 A
    - Input kilovolt-amperes (kVA) (approximately):
      - Minimum configuration: 0.15 kVA
      - Maximum configuration: 1.02 kVA
  - Models with 750 W hot-swap power supplies:
    - 100 - 127 (nominal) V AC; 50 Hz or 60 Hz; 8.9 A
    - 200 - 240 (nominal) V AC; 50 Hz or 60 Hz; 4.5 A
    - Input kilovolt-amperes (kVA) (approximately):
      - Minimum configuration: 0.14 kVA
      - Maximum configuration: 0.90 kVA
  - Models with 550 W hot-swap power supplies:
    - 100 - 127 (nominal) V AC; 50 Hz or 60 Hz; 6.5 A
    - 200 - 240 (nominal) V AC; 50 Hz or 60 Hz; 3.3 A
    - Input kilovolt-amperes (kVA) (approximately):
      - Minimum configuration: 0.12 kVA
      - Maximum configuration: 0.66 kVA
- BTU output
  - Minimum configuration: 406 Btu/hr (119 watts)
  - Maximum configuration: 3480 Btu/hr (1020 watts)
- Noise level
  - 6.6 bels (operating).
  - 6.6 bels (idle).

## Warranty options

The x3630 M4 has a three-year on-site warranty with 9x5/next business day terms. IBM offers the warranty service upgrades through IBM ServicePac offerings, which are described in this section. An IBM ServicePac® offering is a series of prepackaged warranty maintenance upgrades and post-warranty maintenance agreements with a well-defined scope of services, including service hours, response time, term of service, and service agreement terms and conditions.

IBM ServicePac offerings are country-specific, that is, each country might have its own service types, service levels, response times, and terms and conditions. Not all covered types of ServicePac offerings might be available in a particular country. For more information about IBM ServicePac offerings available in your country, visit the IBM ServicePac Product Selector at:

<https://www-304.ibm.com/sales/gss/download/spst/servicepac>

The following table explains warranty service definitions in more detail.

Table 23. Warranty service definitions

Term	Description
IBM on-site repair (IOR)	A service technician comes to the server's location for equipment repair.
24x7x2 hour	A service technician is scheduled to arrive at your client's location within two hours after remote problem determination is completed. We provide service around the clock, every day, including IBM holidays.
24x7x4 hour	A service technician is scheduled to arrive at your client's location within four hours after remote problem determination is completed. We provide service around the clock, every day, including IBM holidays.
9x5x4 hour	A service technician is scheduled to arrive at your client's location within four business hours after remote problem determination is completed. We provide service from 8:00 a.m. - 5:00 p.m. in the client's local time zone, Monday through Friday, excluding IBM holidays. If after 1:00 p.m. it is determined that onsite service is required, the client can expect the service technician to arrive the morning of the following business day. For noncritical service requests, a service technician arrives by the end of the following business day.
9x5 next business day	A service technician is scheduled to arrive at your client's location on the business day after we receive your call, following remote problem determination. We provide service from 8:00 a.m. - 5:00 p.m. in the client's local time zone, Monday through Friday, excluding IBM holidays.

In general, the types of IBM ServicePac offerings are as follows:

- Warranty and maintenance service upgrades:
  - One, two, three, four, or five years of 9x5 or 24x7 service coverage
  - On-site repair from next business day to 2 or 4 hours
  - One or two years of warranty extension
- Remote technical support services:
  - One or three years with 24x7 coverage (severity 1) or 9x5/next business day for all severities
  - Installation and startup support for System x servers
  - Remote technical support for System x servers
  - Software support - Support Line:
    - Microsoft or Linux software
    - VMware
    - IBM Systems Director

## Regulatory compliance

The server conforms to the following standards:

- FCC - Verified to comply with Part 15 of the FCC Rules, Class A
- Canada ICES-003, issue 4, Class A
- UL/IEC 60950-1
- CSA C22.2 No. 60950-1
- NOM-019
- Argentina IEC60950-1
- Japan VCCI, Class A
- Australia/New Zealand AS/NZS CISPR 22, Class A
- IEC 60950-1(CB Certificate and CB Test Report)
- China CCC (GB4943), GB9254 Class A, GB17625.1
- Taiwan BSMI CNS13438, Class A; CNS14336-1
- Korea KN22, Class A; KN24
- Russia/GOST ME01, IEC-60950-1, GOST R 51318.22, GOST R 51318.24, GOST R 51317.3.2, and GOST R 51317.3.3
- CE Mark (EN55022 Class A, EN60950-1, EN55024, EN61000-3-2, and EN61000-3-3)
- CISPR 22, Class A
- TUV-GS (EN60950-1 /IEC60950-1,EK1-ITB2000)

## External disk storage expansion

The x3630 M4 supports attachments to the external storage expansion enclosures, such as the EXP2500 series, using the ServeRAID M5120 SAS/SATA Controller. The x3630 M4 server can also be attached to supported external storage systems, such as the IBM System Storage® DS3500 series, using the supported HBAs listed in Table 15.

The following table provides the ordering part numbers for the ServeRAID M5120 SAS/SATA Controller.

Table 24. Ordering part numbers and feature codes

Part number	Feature code	Description	Maximum supported
81Y4478	A1WX	ServeRAID M5120 SAS/SATA Controller for IBM System x	2
81Y4484	A1J3	ServeRAID M5100 Series 512MB Cache/RAID 5 Upgrade for IBM System x	2
81Y4487	A1J4	ServeRAID M5100 Series 512MB Flash/RAID 5 Upgrade for IBM System x	2
81Y4559	A1WY	ServeRAID M5100 Series 1GB Flash/RAID 5 Upgrade for IBM System x	2
81Y4508	A22E	ServeRAID M5100 Series Battery Kit for IBM System x	2
81Y4546	A1X3	ServeRAID M5100 Series RAID 6 Upgrade for IBM System x	1*
90Y4273	A2MC	ServeRAID M5100 Series SSD Performance Accelerator for IBM System x	1*
90Y4318	A2MD	ServeRAID M5100 Series SSD Caching Enabler for IBM System x	1*

\* One M5100 Series FoD software license is required per server.

**Important:** The ServeRAID M5120 SAS/SATA Controller ships standard without a cache. One of the available cache upgrades (81Y4484, 81Y4487, or 81Y4559) is required for the M5120 adapter operations, and it must be purchased together with the controller.



The ServeRAID M5120 SAS/SATA Controller has the following specifications:

- Eight external 6 Gbps SAS/SATA ports
- Two external x4 mini-SAS connectors (SFF-8088)
- Supports RAID levels 0, 1, and 10
- Supports RAID levels 5 and 50 with optional M5100 Series RAID 5 upgrades
- Supports RAID 6 and 60 with the optional M5100 Series RAID 6 Upgrade
- Supports 512 MB battery-backed cache or 512 MB or 1 GB flash-backed cache (cache)
- Up to 6 Gbps throughput per port
- PCIe 3.0 x8 host interface
- Based on the LSI SAS2208 6 Gbps ROC controller
- Supports connectivity to the EXP2512 and EXP2524 storage expansion enclosures

For more information, see the IBM Redbooks Product Guide *ServeRAID M5120 SAS/SATA Controller for IBM System x* at:

<http://www.redbooks.ibm.com/abstracts/tips0858.html?Open>

The ServeRAID M5120 SAS/SATA Controller supports connectivity to the IBM System Storage external expansion enclosures listed in the following table. Up to nine expansion enclosures can be daisy chained per one M5120 external port. For better performance, distribute expansion enclosures evenly across both M5120 ports.

Table 25. IBM System Storage external expansion enclosures

Part number	Description	Maximum quantity supported per one M5120
174712X	IBM System Storage EXP2512 Express	18
174724X	IBM System Storage EXP2524 Express	9

The external SAS cables listed in the following table support connectivity between external expansion enclosures and the ServeRAID M5120 SAS/SATA Controller.

Table 26. External SAS cables for external storage expansion enclosures

Part number	Description	Maximum quantity supported per one enclosure
39R6531	IBM 3 m SAS Cable	1
39R6529	IBM 1 m SAS Cable	1

The following table lists the drives supported by EXP2512 external expansion enclosures.

Table 27. Drive options for EXP2512 external expansion enclosures

Part number	Description	Maximum quantity supported per one enclosure
<b>3.5-inch NL SAS HS HDDs</b>		
49Y1903	1TB 7,200 rpm 6Gb SAS NL 3.5" HDD	12
49Y1902	2TB 7,200 rpm 6Gb SAS NL 3.5" HDD	12
90Y8720	3TB 7,200 rpm 6Gb SAS NL 3.5" HDD	12
<b>3.5-inch SAS HS HDDs</b>		
49Y1899	300GB 15,000 rpm 6Gb SAS 3.5" HDD	12
49Y1900	450GB 15,000 rpm 6Gb SAS 3.5" HDD	12
49Y1901	600GB 15,000 rpm 6Gb SAS 3.5" HDD	12

The following table lists the hard disk drives supported by EXP2524 external expansion enclosures.

Table 28. Drive options for EXP2524 external expansion enclosures

Part number	Description	Maximum quantity supported per one enclosure
<b>2.5-inch NL SAS HS HDDs</b>		
49Y1898	500GB 7,200 rpm 6Gb SAS NL 2.5" HDD	24
81Y9952	1TB 7,200 rpm 6Gb SAS NL 2.5" HDD	24
<b>2.5-inch SAS HS HDDs</b>		
49Y1896	146GB 15,000 rpm 6Gb SAS 2.5" HDD	24
49Y1895	300GB 10,000 rpm 6Gb SAS 2.5" HDD	24
81Y9944	300GB 15,000 rpm 6Gb SAS 2.5" HDD	24
81Y9596	600GB 10,000 rpm 6Gb SAS 2.5" HDD	24
81Y9948	900GB 10,000 rpm 6Gb SAS 2.5" HDD	24
<b>2.5-inch SAS HS SSDs</b>		
81Y9956	200GB 2.5" SAS SSD	24
81Y9960	400GB 2.5" SAS SSD	24

## External disk storage systems

The following table lists the external storage systems that are supported by the x3630 M4 server and can be ordered through the System x sales channel. The server may support other IBM disk systems that are not listed in this table. For further information, refer to the IBM System Storage Interoperability Center at: <http://www.ibm.com/systems/support/storage/ssic>

Table 29. External disk storage systems

Part number	Description
1746A2D	IBM System Storage DS3512 Express Dual Controller Storage System
1746A2S	IBM System Storage DS3512 Express Single Controller Storage System
1746A4D	IBM System Storage DS3524 Express Dual Controller Storage System
1746A4S	IBM System Storage DS3524 Express Single Controller Storage System
181494H	IBM System Storage DS3950 Model 94
181498H	IBM System Storage DS3950 Model 98
181492H	IBM System Storage EXP395 Expansion Unit
1746A2E	IBM System Storage EXP3512 Express Storage™ Expansion Unit
1746A4E	IBM System Storage EXP3524 Express Storage Expansion Unit

For more information, see the list of IBM Redbooks Product Guides in the System Storage category: <http://www.redbooks.ibm.com/portals/systemx?Open&page=pg&cat=externalstorage>

## External backup units

The server supports the external backup attachment options listed in the following table.

Table 30. External backup options (Part 1)

Part number	Description
External tape expansion enclosures for internal tape drives	
87651UX	1U Tape Drive Enclosure
8767HHX	Half High Tape Drive Enclosure
87651NX	1U Tape Drive Enclosure (with Nema 5-15P LineCord)
8767HNX	Half High Tape Drive Enclosure (with Nema 5-15P LineCord)
Tape enclosure adapters (with cables)	
44E8869	USB Enclosure Adapter Kit
40K2599	SAS Enclosure Adapter Kit
Internal backup drives supported by external tape enclosures	
46C5399	IBM DDS Generation 5 USB Tape Drive
39M5636	IBM DDS Generation 6 USB Tape Drive
43W8478	IBM Half High LTO Gen 3 SAS Tape Drive
44E8895	IBM Half High LTO Gen 4 SAS Tape Drive
49Y9898	IBM Half High LTO Gen 5 Internal SAS Tape Drive
00D8924	IBM Half High LTO Ultrium Gen 6 Internal SAS Tape Drive

Table 30. External backup options (Part 2)

Part number	Description
External backup units*	
36251TY	IBM RDX USB 3.0 Dock with 1TB Cartridge
362532Y	IBM RDX USB 3.0 Dock with 320GB Cartridge
362550Y	IBM RDX USB 3.0 Dock with 500GB Cartridge
3628L3X	IBM Half High LTO Gen 3 External SAS Tape Drive (with US line cord)
3628L4X	IBM Half High LTO Gen 4 External SAS Tape Drive (with US line cord)
3628L5X	IBM Half High LTO Gen 5 External SAS Tape Drive (with US line cord)
3628N3X	IBM Half High LTO Gen 3 External SAS Tape Drive (without line cord)
3628N4X	IBM Half High LTO Gen 4 External SAS Tape Drive (without line cord)
3628N5X	IBM Half High LTO Gen 5 External SAS Tape Drive (without line cord)
3580S3V	System Storage TS2230 Tape Drive Express Model H3V
3580S4V	System Storage TS2240 Tape Drive Express Model H4V
3580S5E	System Storage TS2250 Tape Drive Express Model H5S
3580S5X	System Storage TS2350 Tape Drive Express Model S53
3572S4R	TS2900 Tape Library with LTO4 HH SAS drive & rack mount kit
3572S5R	TS2900 Tape Library with LTO5 HH SAS drive & rack mount kit
35732UL	TS3100 Tape Library Model L2U Driveless
35734UL	TS3200 Tape Library Model L4U Driveless
46X2682†	LTO Ultrium 5 Fibre Channel Drive
46X2683†	LTO Ultrium 5 SAS Drive Sled
46X2684†	LTO Ultrium 5 Half High Fibre Drive Sled
46X2685†	LTO Ultrium 5 Half High SAS Drive Sled
46X6912†	LTO Ultrium 4 Half High Fibre Channel Drive Sled
46X7117†	LTO Ultrium 4 Half High SAS DriveV2 Sled
46X7122†	LTO Ultrium 3 Half High SAS DriveV2 Sled

\* Note: The external tape drives listed can be ordered through the IBM System x sales channel. The server may support other IBM tape drives that are not listed in this table. For further information, refer to the IBM System Storage Interoperability Center.

† Note: These part numbers are the tape drives options for 35732UL and 35734UL.

For more information, see the list of IBM Redbooks Product Guides in the Backup units category:  
<http://www.redbooks.ibm.com/portals/systemx?Open&page=pg&cat=tape>

## Top-of-rack Ethernet switches

The server supports the top-of-rack Ethernet switches from IBM System Networking listed in the following table.

Table 31. IBM System Networking - Top-of-rack switches

Part number	Description
IBM System Networking - 1 Gb top-of-rack switches	
0446013	IBM System Networking RackSwitch G8000R
7309CFC	IBM System Networking RackSwitch G8000F
7309CD8	IBM System Networking RackSwitch G8000DC
7309G52	IBM System Networking RackSwitch G8052R
730952F	IBM System Networking RackSwitch G8052F
427348E	IBM Ethernet Switch J48E
6630010	Juniper Networks EX2200 24 Port
6630011	Juniper Networks EX2200 24 Port with PoE
6630012	Juniper Networks EX2200 48 Port
6630013	Juniper Networks EX2200 48 Port with PoE
IBM System Networking - 10 Gb top-of-rack switches	
7309DRX	IBM System Networking RackSwitch G8264CS (Rear to Front)
7309DFX	IBM System Networking RackSwitch G8264CS (Front to Rear)
7309BD5	IBM System Networking RackSwitch G8124DC
7309BR6	IBM System Networking RackSwitch G8124ER
7309BF7	IBM System Networking RackSwitch G8124EF
7309G64	IBM System Networking RackSwitch G8264R
730964F	IBM System Networking RackSwitch G8264F
7309CR9	IBM System Networking RackSwitch G8264TR
7309CF9	IBM System Networking RackSwitch G8264TF
0719410	Juniper Networks EX4500 - Front to Back Airflow
0719420	Juniper Networks EX4500 - Back to Front Airflow
IBM System Networking - 40 Gb top-of-rack switches	
8036ARX	IBM System Networking RackSwitch G8316R
8036AFX	IBM System Networking RackSwitch G8316F

For more information, see the list of IBM Redbooks Product Guides in the Top-of-rack switches category: <http://www.redbooks.ibm.com/portals/systemx?Open&page=pg&cat=tor>

## Uninterruptible power supply units

The server supports attachment to the uninterruptible power supply (UPS) units listed in the following table.

Table 32. Uninterruptible power supply units

Part number	Description
Rack-mounted UPS	
21303RX	IBM UPS 7500XHV
21304RX	IBM UPS 10000XHV
24195KX	IBM UPS5000
53951AX	IBM 1500VA LCD 2U Rack UPS (100V/120V)
53951KX	IBM 1500VA LCD 2U Rack UPS (230V)
53952AX	IBM 2200VA LCD 2U Rack UPS (100V/120V)
53952KX	IBM 2200VA LCD 2U Rack UPS (230V)
53953AX	IBM 3000VA LCD 3U Rack UPS (100 V/120 V)
53953JX	IBM 3000VA LCD 3U Rack UPS (200 V/208 V)
53956AX	IBM 6000VA LCD 4U Rack UPS (200 V/208 V)
53956KX	IBM 6000VA LCD 4U Rack UPS (230 V)
53959KX	IBM 11000VA LCD 5U Rack UPS (200V/208V/230V)

For more information, see the list of IBM Redbooks Product Guides in the Power infrastructure category:  
<http://www.redbooks.ibm.com/portals/systemx?Open&page=pg&cat=power>

## Power distribution units

The server supports attachments to the power distribution units (PDUs) listed in the following table.

Table 33. Power distribution units (part 1)

Part number	Description
Switched and Monitored PDUs	
46M4002	IBM 1U 9 C19/3 C13 Active Energy Manager DPI® PDU
46M4003	IBM 1U 9 C19/3 C13 Active Energy Manager 60A 3 Phase PDU
46M4004	IBM 1U 12 C13 Active Energy Manager DPI PDU
46M4005	IBM 1U 12 C13 Active Energy Manager 60A 3 Phase PDU
46M4167	IBM 1U 9 C19/3 C13 Switched and Monitored 30A 3 Phase PDU
46M4116	IBM 0U 24 C13 Switched and Monitored 30A PDU
46M4119	IBM 0U 24 C13 Switched and Monitored 32A PDU
46M4134	IBM 0U 12 C19/12 C13 Switched and Monitored 50A 3 Phase PDU
46M4137	IBM 0U 12 C19/12 C13 Switched and Monitored 32A 3 Phase PDU
Enterprise PDUs	
71762MX	IBM Ultra Density Enterprise PDU C19 PDU+ (WW)
71762NX	IBM Ultra Density Enterprise PDU C19 PDU (WW)
71763MU	IBM Ultra Density Enterprise PDU C19 3 Phase 60A PDU+ (NA)
71763NU	IBM Ultra Density Enterprise PDU C19 3 Phase 60A PDU (NA)
39M2816	IBM DPI C13 Enterprise PDU without linecord
39Y8923	DPI 60A Three Phase C19 Enterprise PDU with IEC309 3P+G (208 V) fixed line cord
39Y8941	DPI Single Phase C13 Enterprise PDU without line cord
39Y8948	DPI Single Phase C19 Enterprise PDU without line cord
Front-end PDUs	
39Y8934	DPI 32 amp/250 V Front-end PDU with IEC 309 2P+Gnd connector
39Y8935	DPI 63amp/250 V Front-end PDU with IEC 309 2P+Gnd connector
39Y8938	30 amp/125 V Front-end PDU with NEMA L5-30P connector
39Y8939	30 amp/250 V Front-end PDU with NEMA L6-30P connector
39Y8940	60 amp/250 V Front-end PDU with IEC 309 60A 2P+N+Gnd connector



Table 33. Power distribution units (part 2)

Part number	Description
Universal PDUs	
39Y8951	DPI Universal Rack PDU with US LV and HV line cords
39Y8952	DPI Universal Rack PDU with CEE7-VII Europe LC
39Y8953	DPI Universal Rack PDU with Denmark LC
39Y8954	DPI Universal Rack PDU with Israel LC
39Y8955	DPI Universal Rack PDU with Italy LC
39Y8956	DPI Universal Rack PDU with South Africa LC
39Y8957	DPI Universal Rack PDU with UK LC
39Y8958	DPI Universal Rack PDU with AS/NZ LC
39Y8959	DPI Universal Rack PDU with China LC
39Y8962	DPI Universal Rack PDU (Argentina)
39Y8960	DPI Universal Rack PDU (Brazil)
39Y8961	DPI Universal Rack PDU (India)
0U Basic PDUs	
46M4122	IBM 0U 24 C13 16A 3 Phase PDU
46M4125	IBM 0U 24 C13 30A 3 Phase PDU
46M4128	IBM 0U 24 C13 30A PDU
46M4131	IBM 0U 24 C13 32A PDU
46M4140	IBM 0U 12 C19/12 C13 60A 3 Phase PDU
46M4143	IBM 0U 12 C19/12 C13 32A 3 Phase PDU

For more information, see the list of IBM Redbooks Product Guides in the Power infrastructure category:  
<http://www.redbooks.ibm.com/portals/systemx?Open&page=pg&cat=power>

## Rack cabinets

The server supports the rack cabinets listed in the following table.

Table 34. Rack cabinets

Part number	Description
201886X	IBM 11U Office Enablement Kit
93072PX	IBM 25U Static S2 Standard Rack
93072RX	IBM 25U Standard Rack
93074RX	IBM 42U Standard Rack
93074XX	IBM 42U Standard Rack Extension
93084EX	IBM 42U Enterprise Expansion Rack
93084PX	IBM 42U Enterprise Rack
93604EX	IBM 42U 1200 mm Deep Dynamic Expansion Rack
93604PX	IBM 42U 1200 mm Deep Dynamic Rack
93614EX	IBM 42U 1200 mm Deep Static Expansion Rack
93614PX	IBM 42U 1200 mm Deep Static Rack
93624EX	IBM 47U 1200 mm Deep Static Expansion Rack
93624PX	IBM 47U 1200 mm Deep Static Rack
99564RX	IBM S2 42U Dynamic Standard Rack
99564XX	IBM S2 42U Dynamic Standard Expansion Rack

For more information, see the list of IBM Redbooks Product Guides in the Rack cabinets and options category:

<http://www.redbooks.ibm.com/portals/systemx?Open&page=pg&cat=rack>

## Rack options

The server supports the rack console switches and monitor kits listed in the following table.

Table 35. Rack options

Part number	Feature code	Description
Monitor kits and keyboard trays		
172317X	1723HC1 fc 0051	1U 17in Flat Panel Console Kit
172319X	1723HC1 fc 0052	1U 19in Flat Panel Console Kit
Console switches		
1754D2X	1754HC2 fc 6695	IBM Global 4x2x32 Console Manager (GCM32)
1754D1X	1754HC1 fc 6694	IBM Global 2x2x16 Console Manager (GCM16)
1754A2X	1754HC4 fc 0726	IBM Local 2x16 Console Manager (LCM16)
1754A1X	1754HC3 fc 0725	IBM Local 1x8 Console Manager (LCM8)
Console cables		
43V6147	3757	IBM Single Cable USB Conversion Option (UCO)
39M2895	3756	IBM USB Conversion Option (4 Pack UCO)
39M2897	3754	IBM Long KVM Conversion Option (4 Pack Long KCO)
46M5383	5341	IBM Virtual Media Conversion Option Gen2 (VCO2)
46M5382	5340	IBM Serial Conversion Option (SCO)
Rail kit		
00W2146	A207	Rail Kit for x3630 M4 and x3530 M4 (standard with all models)

For more information, see the list of IBM Redbooks Product Guides in the Rack cabinets and options category:

<http://www.redbooks.ibm.com/portals/systemx?Open&page=pg&cat=rack>

## IBM Global Financing

IBM Global Financing can help you obtain the IT solution you need while preserving funding for other strategic investments and optimizing cash flow. Our Fair Market Value (FMV) lease helps ensure that you have the latest IBM technology, and with our mid-lease upgrade capability, you can increase the capacity of the system with little to no change in monthly payments. At the end of the lease, take advantage of our flexible end-of-lease options to fit your changing business needs. IBM Global Financing has the breadth and depth of offerings, longevity, proven success, and global reach to help you develop a robust financing and asset management strategy that provides you the opportunity to use new technologies and turn your ambitious vision into a tangible solution.

Here are some other reasons why working with us makes solid financial sense:

- Expand your purchasing power: Affordable monthly payments allow you to change the technology acquisition discussion from “what can I afford right now” to “what solution is really right for my business.” IBM Global Financing allows you to expand your purchasing power to get you the right solution.
- Accelerate your project’s cash flow break-even point: Acquire your IBM technology today and begin to realize its benefits now. An FMV lease can help you get the solution you need now, with low monthly payments that better align up-front costs with the anticipated return on investment (ROI) from the technology.
- Easy to acquire with affordable rates: We offer one-stop shopping for a total IT solution, so you can acquire IBM hardware, software, services and the financing you need from one IT provider.

Plus, we provide simple, easy-to-understand contracts and quick approvals. As the world’s largest IT financing provider, with an asset base of US\$35.8 billion and over 125,000 customers, IBM Global Financing offers highly competitive rates that promote low total cost of ownership (TCO) and low monthly payments.

IBM Global Financing operates in more than 50 countries. Go to <http://ibm.com/financing> for financing options in your country and to contact a local financing specialist.

IBM Global Financing offerings are provided through IBM Credit LLC in the United States and other IBM subsidiaries and divisions worldwide to qualified commercial and government clients. Rates and availability subject to client’s credit rating, financing terms, offering type, equipment and product type and options, and may vary by country. Non-hardware items must be one-time, nonrecurring charges and are financed by means of loans. Other restrictions may apply. Rates and offerings are subject to change, extension or withdrawal without notice and may not be available in all countries. Contact your local IBM Global Financing representative for additional detail.

## Related publications and links

For more information, see these resources:

- US Announcement Letter - IBM System x3630 M4:  
<http://ibm.com/common/ssi/cgi-bin/ssialias?infotype=dd&subtype=ca&&htmlfid=897/ENUS112-095>
- IBM System x3630 M4 product page:  
<http://www.ibm.com/systems/x/hardware/rack/x3630m4/index.html>
- *IBM System x3630 M4 Installation and User's Guide:*  
<http://ibm.com/support/entry/portal/docdisplay?Indocid=MIGR-5090171>
- *IBM System x3630 M4 Problem Determination and Service Guide:*  
<http://ibm.com/support/entry/portal/docdisplay?Indocid=MIGR-5090165>
- ServerProven hardware compatibility page for the x3630 M4:  
<http://www.ibm.com/systems/info/x86servers/serverproven/compat/us/xseries/7158.html>
- IBM Redbooks Product Guides for IBM System x servers and options:  
<http://www.redbooks.ibm.com/portals/systemx?Open&page=pgbycat>
- IBM System x DDR3 Memory Configurator:  
<http://www.ibm.com/systems/x/hardware/ddr3config/>
- *Configuration and Option Guide:*  
<http://www.ibm.com/systems/xbc/cog/>
- xREF - IBM System x Reference Sheets:  
<http://www.redbooks.ibm.com/xref>
- IBM System x Support Portal:  
<http://ibm.com/support/entry/portal/>  
[http://ibm.com/support/entry/portal/Downloads/Hardware/Systems/System\\_x/System\\_x3530\\_M4](http://ibm.com/support/entry/portal/Downloads/Hardware/Systems/System_x/System_x3530_M4)
- IBM System Storage Interoperability Center:  
<http://www.ibm.com/systems/support/storage/ssic>

# Notices

This information was developed for products and services offered in the U.S.A.

IBM may not offer the products, services, or features discussed in this document in other countries. Consult your local IBM representative for information on the products and services currently available in your area. Any reference to an IBM product, program, or service is not intended to state or imply that only that IBM product, program, or service may be used. Any functionally equivalent product, program, or service that does not infringe any IBM intellectual property right may be used instead. However, it is the user's responsibility to evaluate and verify the operation of any non-IBM product, program, or service. IBM may have patents or pending patent applications covering subject matter described in this document. The furnishing of this document does not give you any license to these patents. You can send license inquiries, in writing, to:

*IBM Director of Licensing, IBM Corporation, North Castle Drive, Armonk, NY 10504-1785 U.S.A.*

**The following paragraph does not apply to the United Kingdom or any other country where such provisions are inconsistent with local law:** INTERNATIONAL BUSINESS MACHINES CORPORATION PROVIDES THIS PUBLICATION "AS IS" WITHOUT WARRANTY OF ANY KIND, EITHER EXPRESS OR IMPLIED, INCLUDING, BUT NOT LIMITED TO, THE IMPLIED WARRANTIES OF NON-INFRINGEMENT, MERCHANTABILITY OR FITNESS FOR A PARTICULAR PURPOSE. Some states do not allow disclaimer of express or implied warranties in certain transactions, therefore, this statement may not apply to you. This information could include technical inaccuracies or typographical errors. Changes are periodically made to the information herein; these changes will be incorporated in new editions of the publication. IBM may make improvements and/or changes in the product(s) and/or the program(s) described in this publication at any time without notice.

Any references in this information to non-IBM Web sites are provided for convenience only and do not in any manner serve as an endorsement of those Web sites. The materials at those Web sites are not part of the materials for this IBM product and use of those Web sites is at your own risk. IBM may use or distribute any of the information you supply in any way it believes appropriate without incurring any obligation to you. Information concerning non-IBM products was obtained from the suppliers of those products, their published announcements or other publicly available sources. IBM has not tested those products and cannot confirm the accuracy of performance, compatibility or any other claims related to non-IBM products. Questions on the capabilities of non-IBM products should be addressed to the suppliers of those products. This information contains examples of data and reports used in daily business operations. To illustrate them as completely as possible, the examples include the names of individuals, companies, brands, and products. All of these names are fictitious and any similarity to the names and addresses used by an actual business enterprise is entirely coincidental.

Any performance data contained herein was determined in a controlled environment. Therefore, the results obtained in other operating environments may vary significantly. Some measurements may have been made on development-level systems and there is no guarantee that these measurements will be the same on generally available systems. Furthermore, some measurement may have been estimated through extrapolation. Actual results may vary. Users of this document should verify the applicable data for their specific environment.

## COPYRIGHT LICENSE:

This information contains sample application programs in source language, which illustrate programming techniques on various operating platforms. You may copy, modify, and distribute these sample programs in any form without payment to IBM, for the purposes of developing, using, marketing or distributing application programs conforming to the application programming interface for the operating platform for which the sample programs are written. These examples have not been thoroughly tested under all conditions. IBM, therefore, cannot guarantee or imply reliability, serviceability, or function of these programs.

**© Copyright International Business Machines Corporation 2012. All rights reserved.**

Note to U.S. Government Users Restricted Rights -- Use, duplication or disclosure restricted by GSA ADP Schedule Contract with IBM Corp.

This document was created or updated on June 21, 2013.

Send us your comments in one of the following ways:

- Use the online **Contact us** review form found at:  
[ibm.com/redbooks](http://ibm.com/redbooks)
- Send your comments in an e-mail to:  
[redbook@us.ibm.com](mailto:redbook@us.ibm.com)
- Mail your comments to:  
IBM Corporation, International Technical Support Organization  
Dept. HYTD Mail Station P099  
2455 South Road  
Poughkeepsie, NY 12601-5400 U.S.A.

This document is available online at <http://www.ibm.com/redbooks/abstracts/tips0889.html> .

## Trademarks

IBM, the IBM logo, and [ibm.com](http://ibm.com) are trademarks or registered trademarks of International Business Machines Corporation in the United States, other countries, or both. These and other IBM trademarked terms are marked on their first occurrence in this information with the appropriate symbol (® or ™), indicating US registered or common law trademarks owned by IBM at the time this information was published. Such trademarks may also be registered or common law trademarks in other countries. A current list of IBM trademarks is available on the Web at <http://www.ibm.com/legal/copytrade.shtml>

The following terms are trademarks of the International Business Machines Corporation in the United States, other countries, or both:

Calibrated Vektored Cooling™  
Express Storage™  
IBM Systems Director Active Energy Manager™  
IBM®  
Redbooks®  
Redbooks (logo)®  
ServerProven®  
ServicePac®  
System Storage®  
System x®

The following terms are trademarks of other companies:

Intel Xeon, Intel, Pentium, Intel logo, Intel Inside logo, and Intel Centrino logo are trademarks or registered trademarks of Intel Corporation or its subsidiaries in the United States and other countries.

LTO, Ultrium, the LTO Logo and the Ultrium logo are trademarks of HP, IBM Corp. and Quantum in the U.S. and other countries.

Microsoft, Windows, and the Windows logo are trademarks of Microsoft Corporation in the United States, other countries, or both.

Other company, product, or service names may be trademarks or service marks of others.